

L'ARTE  LUCE®

L

I

G

H

T

I

N

G



#### About Aurora

Aurora, a crystal art lighting brand, inherits the century old Swedish crystal technology. Each work of Aurora reflects the founder's carving of the texture of light and the dedication of manual crystal technology. Aurora is the only crystal art lighting brand in China with the integration of manual art crystal studio and lighting R & D and production. Aurora products cover modern functional lighting and engineering crystal installation art.













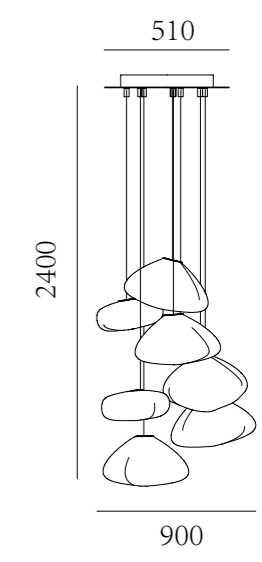
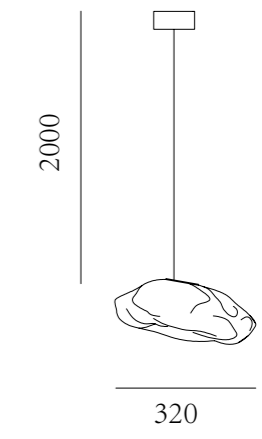
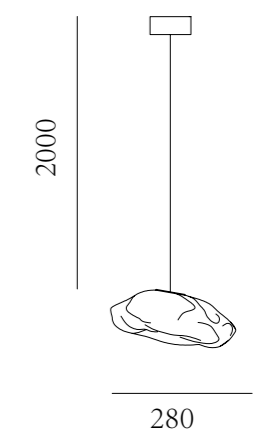

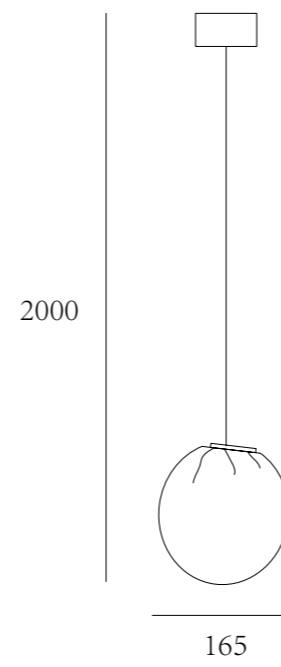

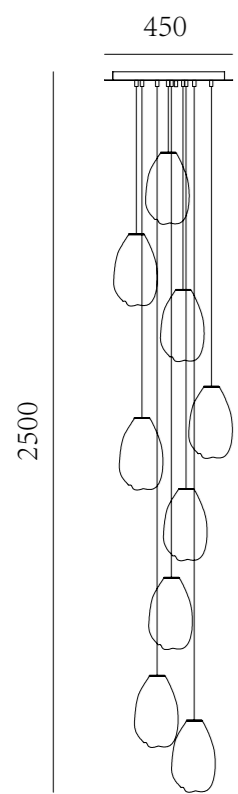

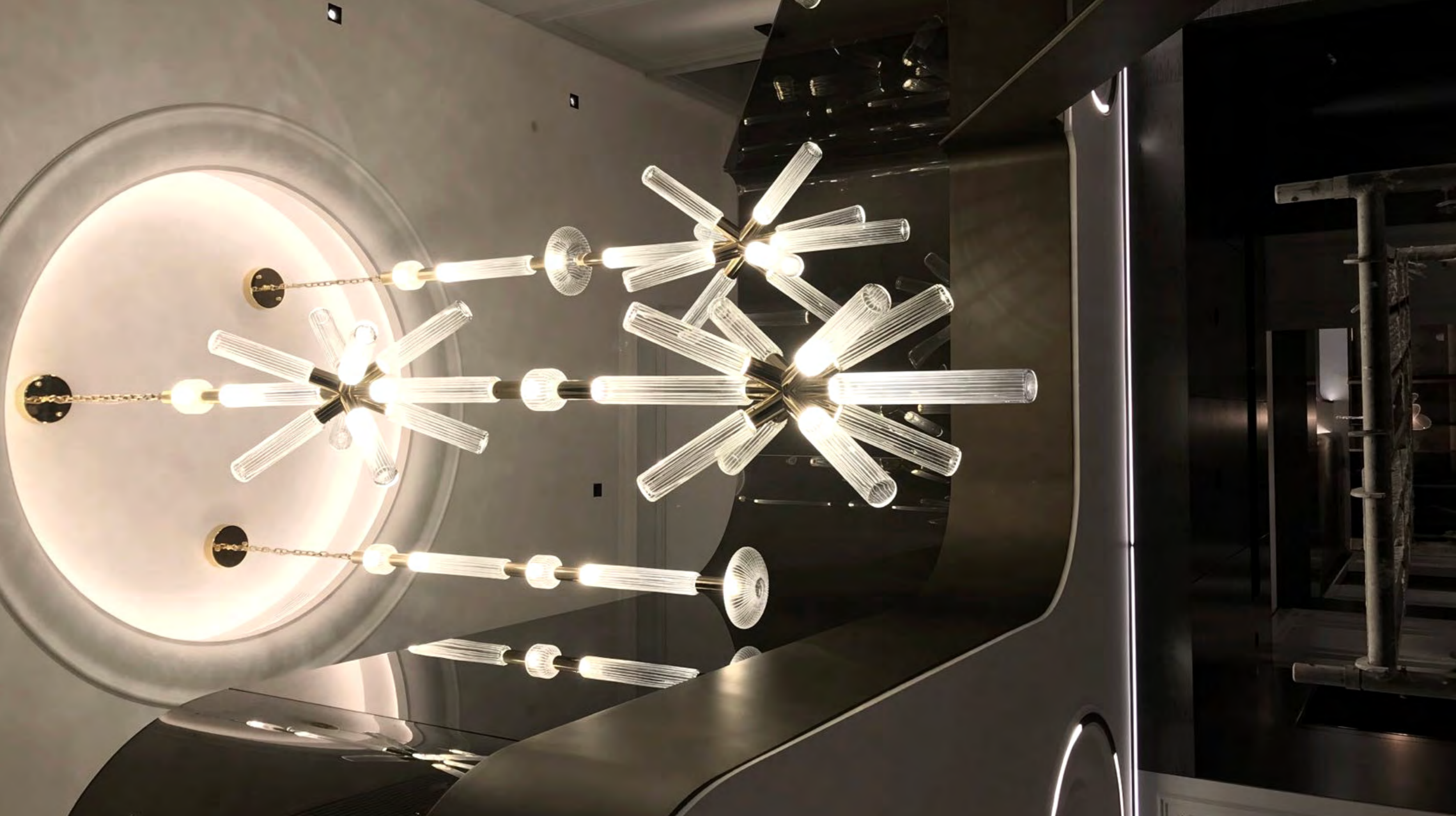























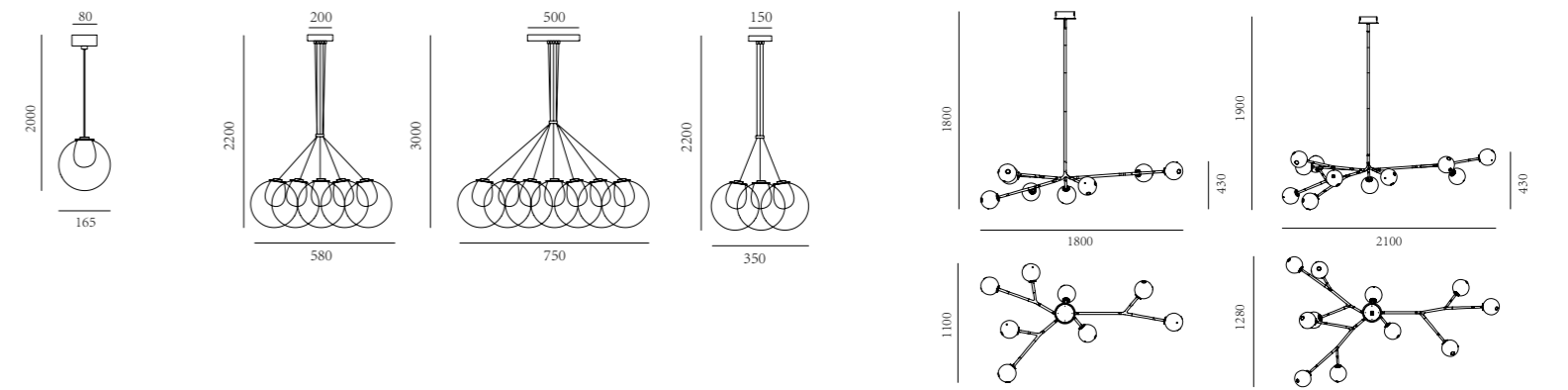



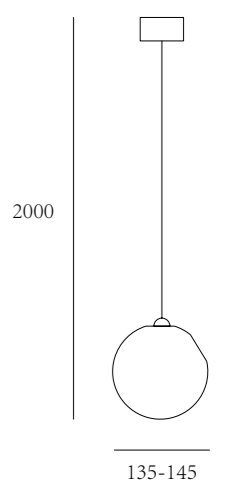







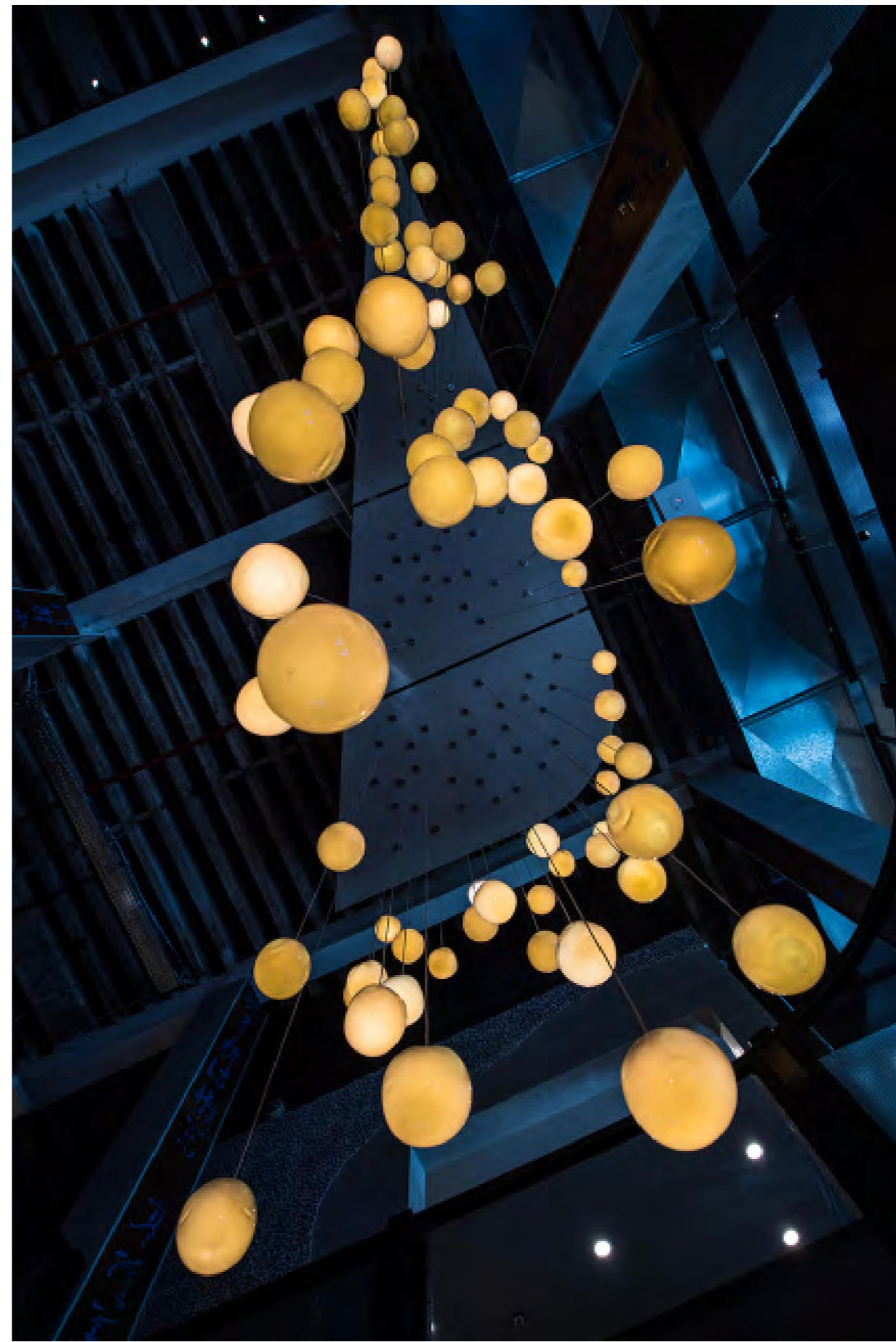

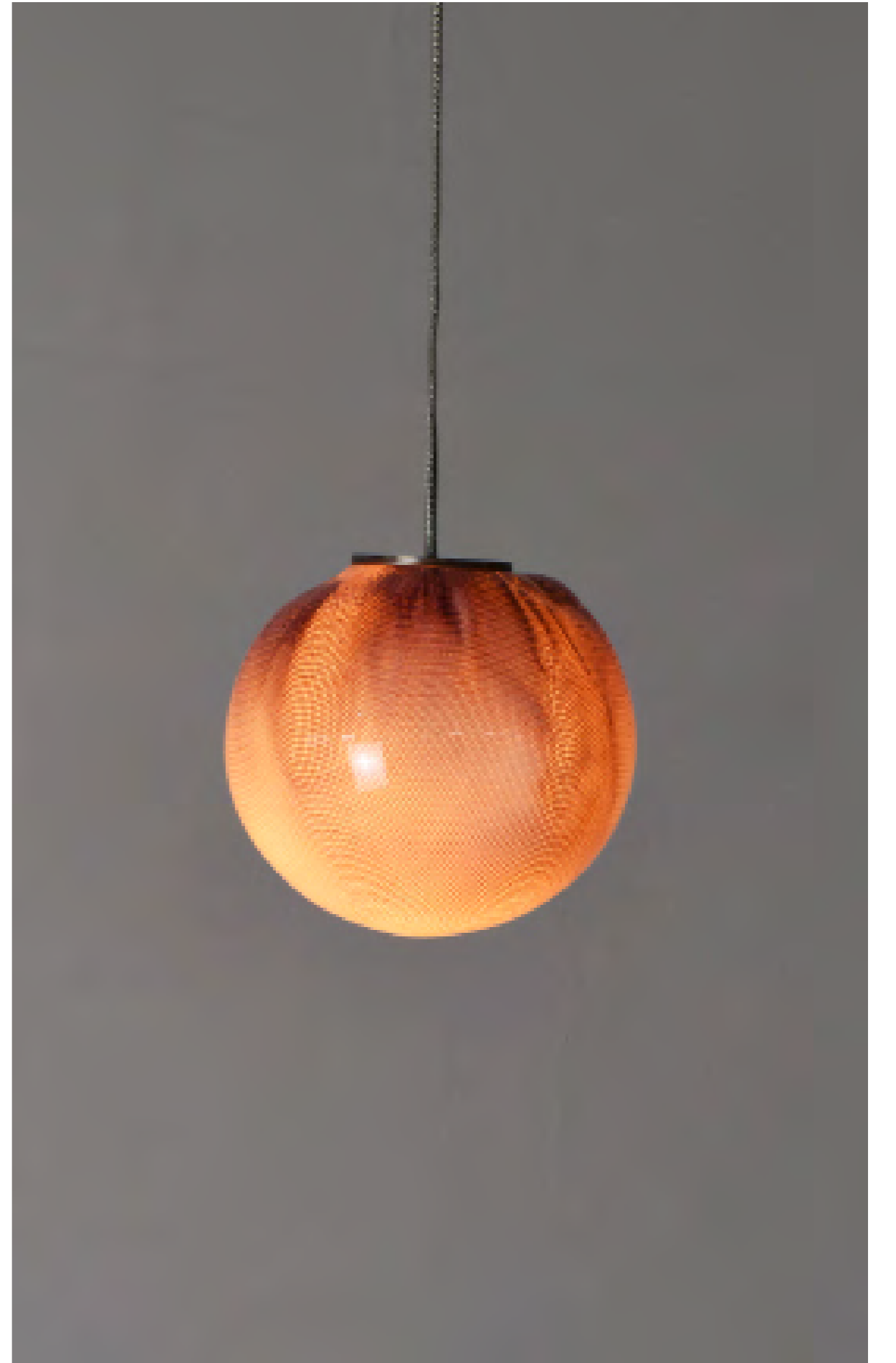



G4:2200K

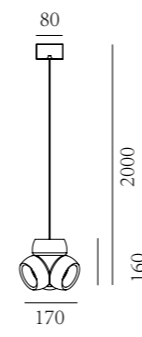
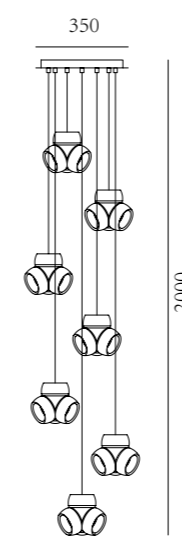
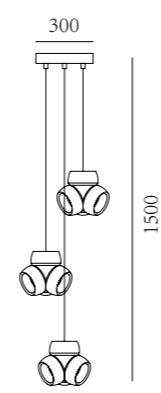
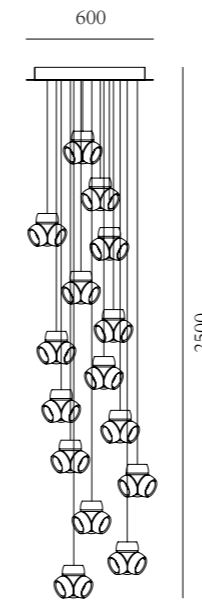
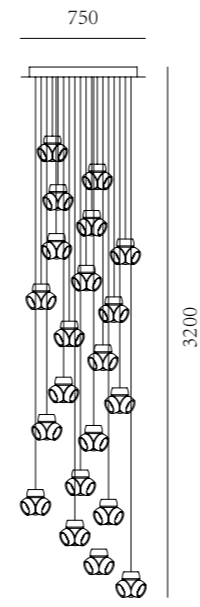

G4:1800K



Simple texture, exquisite light effect, atmosphere color temperature adjustment, to provide the most subtle lighting requirements - AURORA











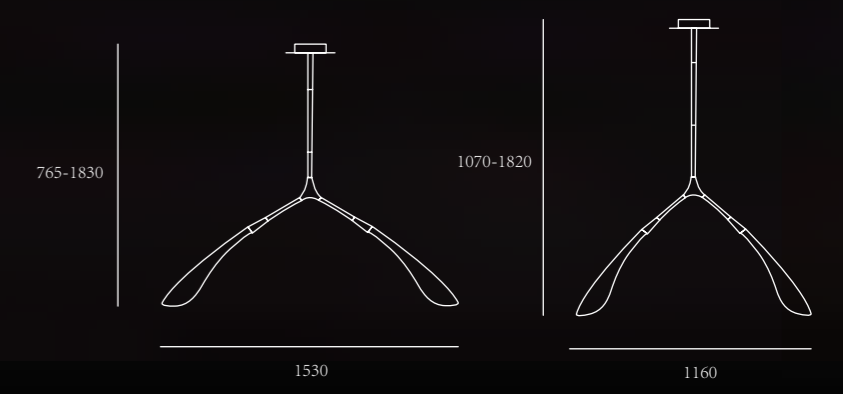

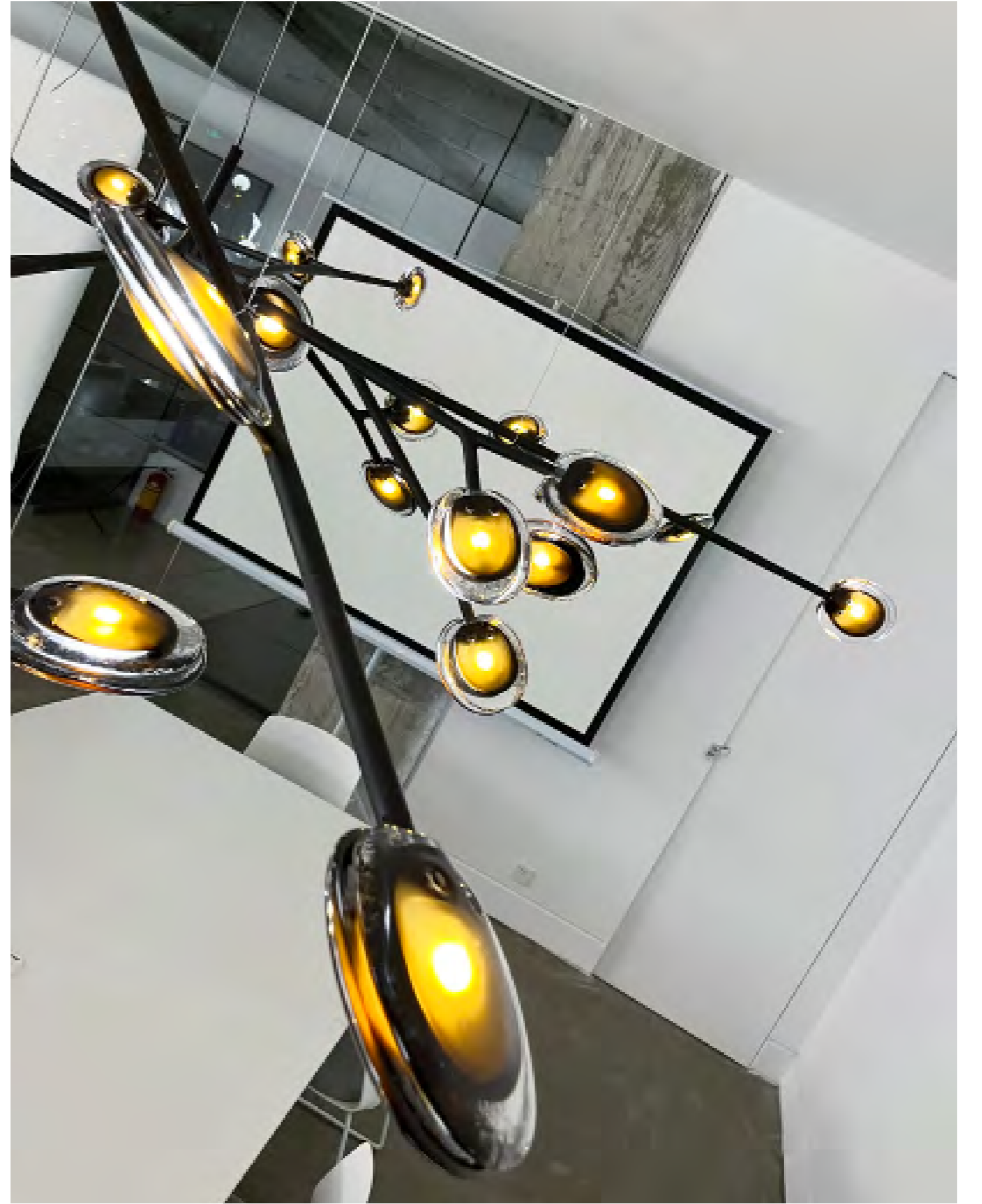





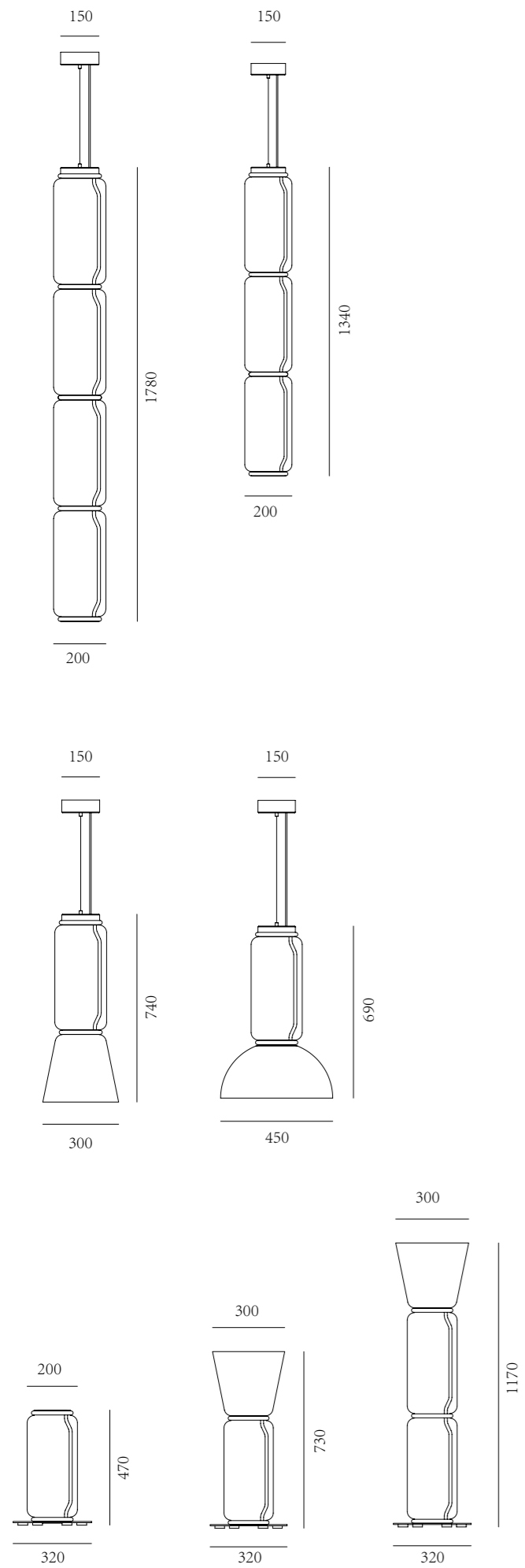

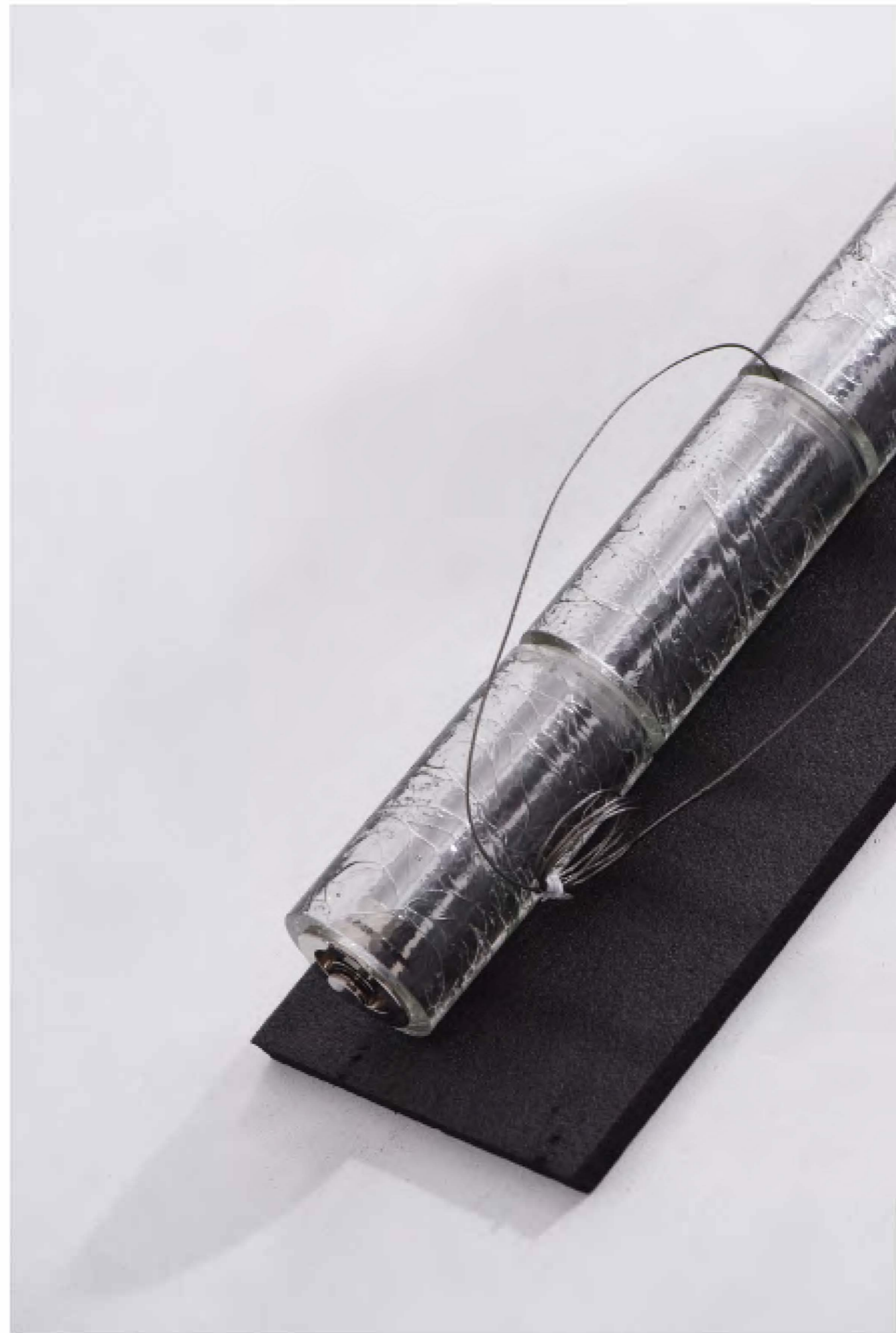





The "contact control" can be used for up-down lighting and dimming, color temperature 3000K.



The "contact control" can be used for up-down lighting and dimming, color temperature 3000K.

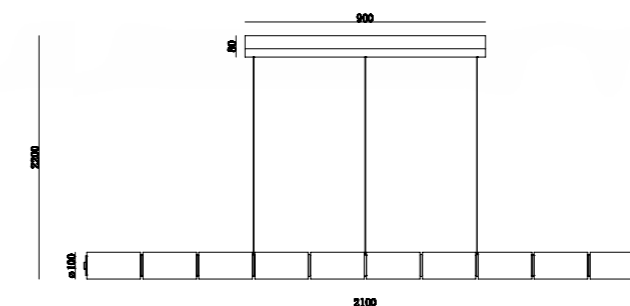
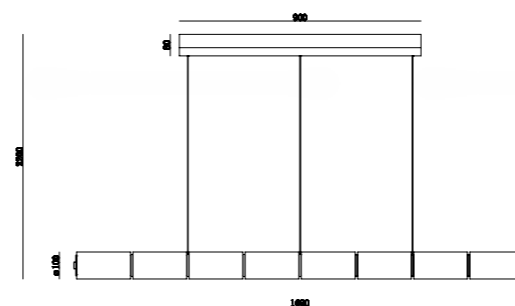

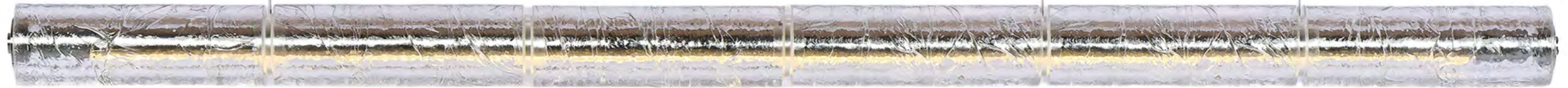

Light can be switched on and dimmed by "contact control", color temperature 3000K.

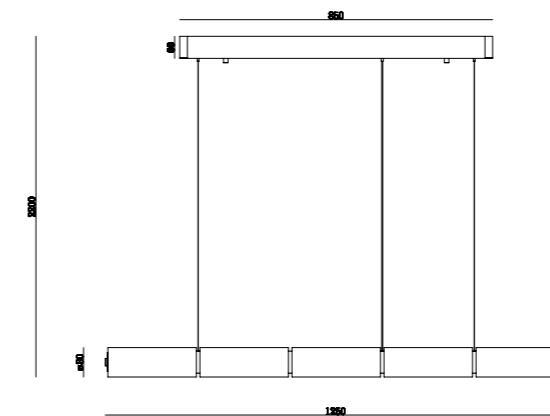
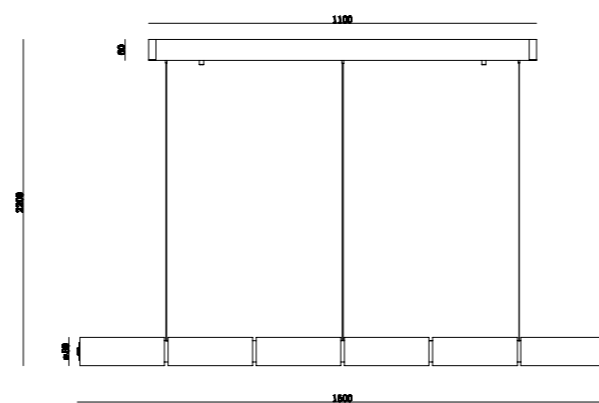



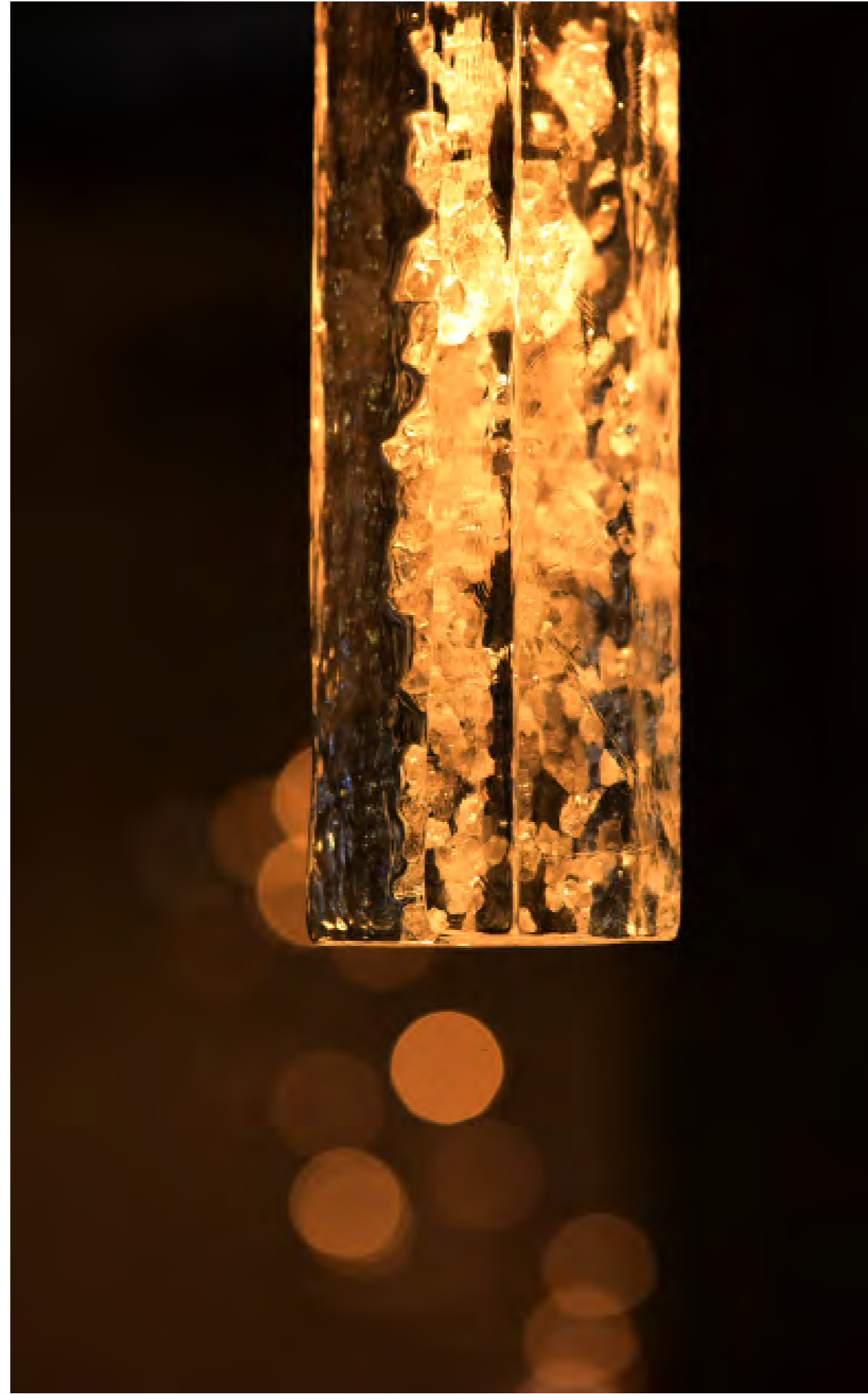

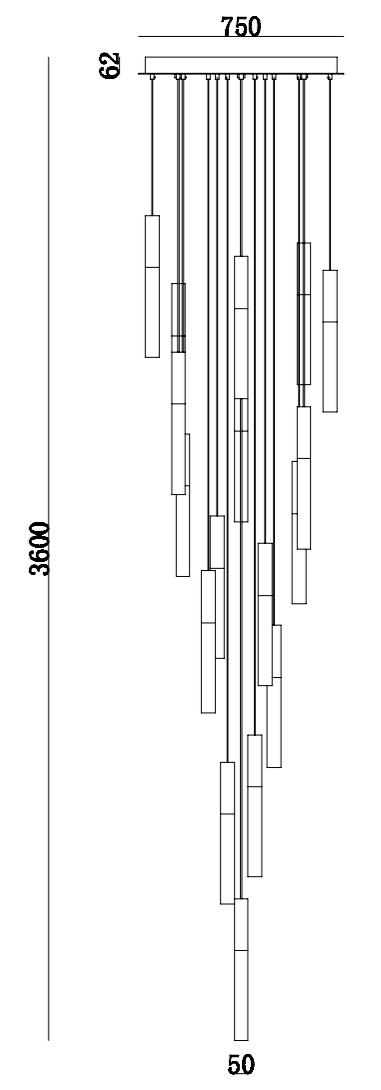
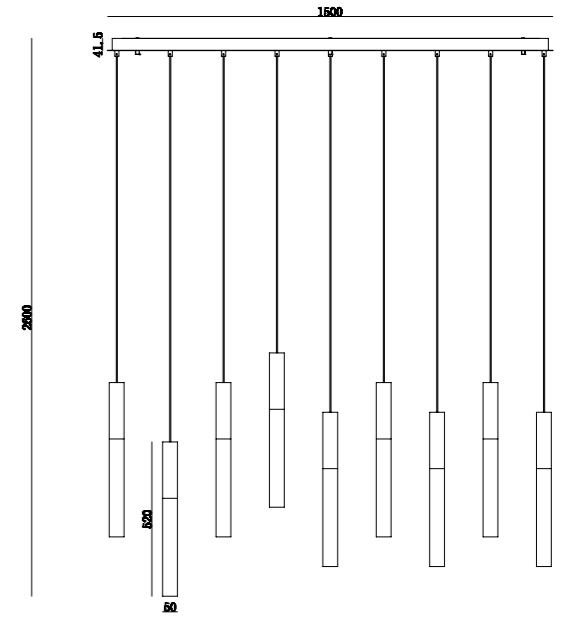
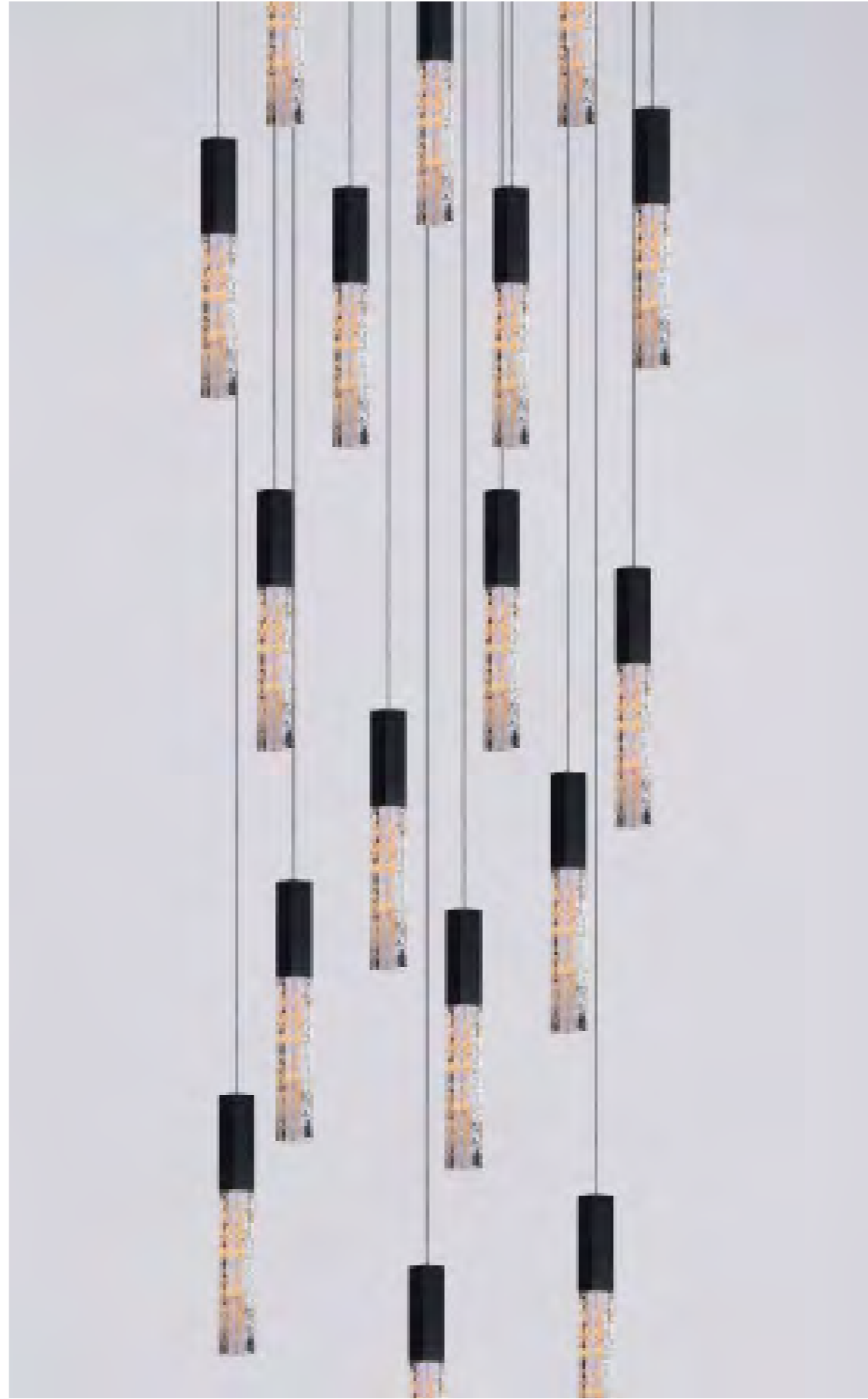



3000

650 (21)

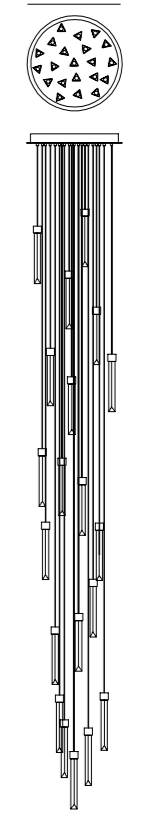

AURORA Design is a celebration of simple form, materiality and a lasting, timeless aesthetic. We infuse each design with soulful poetry, elevating lighting to an art form.



