

NOVELTIES 2025

Lumen center.

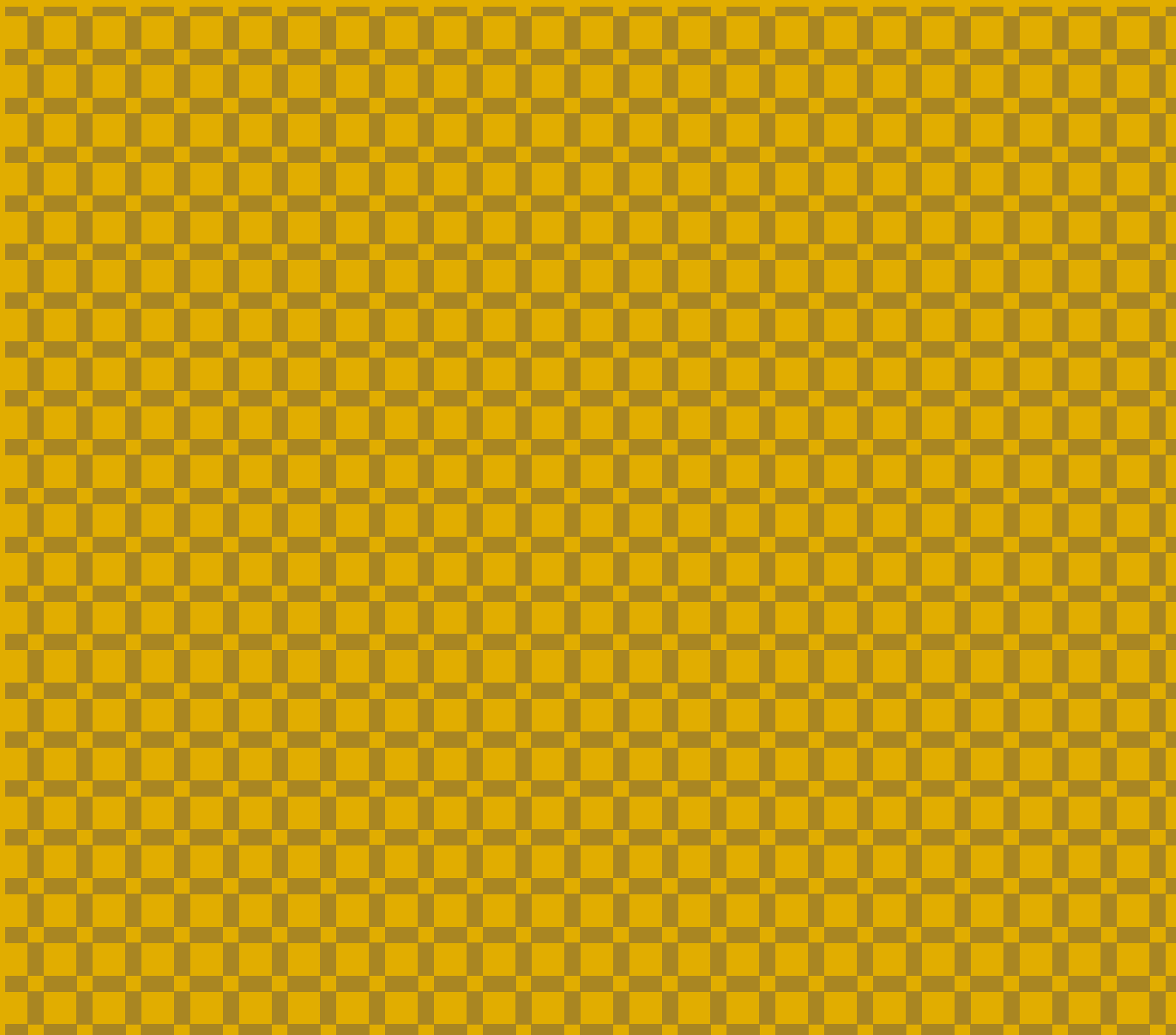

**Lumen
center.**

_ Index

18	MINUS
14	SKYLINES Family SKYLINES WALL - CEILING
10	WASHINGTON Family WASHINGTON WALL
24	ZERO Family DOPPIO ZERO
	—
26	COLOURS & FINISHES



— Jean-Michel Wilmotte

— Nel 1975, Jean-Michel Wilmotte fondò il suo studio di architettura a Parigi, noto come Wilmotte & Associés, offrendo servizi che vanno dalla progettazione architettonica al design di prodotti e musei. Con un approccio eclettico e attento ai dettagli, Wilmotte & Associés realizza progetti in diversi settori, tra cui negozi, hotel di lusso e strutture pubbliche.

— In 1975, Jean-Michel Wilmotte founded his architecture studio in Paris, known as Wilmotte & Associés, which offers services ranging from architectural design to product and museum design. With an eclectic and detail-oriented approach, Wilmotte & Associés undertakes projects in various sectors, including retail, luxury hotels, and public facilities.

— En 1975, Jean-Michel Wilmotte a fondé son cabinet d'architecture à Paris, connu sous le nom de Wilmotte & Associés, qui propose des services allant de la conception architecturale au design de produits et de musées. Avec une approche éclectique et soucieuse du détail, Wilmotte & Associés réalise des projets dans différents secteurs, notamment les magasins, les hôtels de luxe et les infrastructures publiques.

— Im Jahr 1975 gründete Jean-Michel Wilmotte sein Architekturbüro in Paris, bekannt als Wilmotte & Associés, das Dienstleistungen von der architektonischen Gestaltung bis zum Produktdesign und Museumsdesign anbietet. Mit einem eklektischen und detailorientierten Ansatz realisiert Wilmotte & Associés Projekte in verschiedenen Bereichen, darunter Einzelhandelsgeschäfte, Luxushotels und öffentliche Einrichtungen.

_ Washington Family

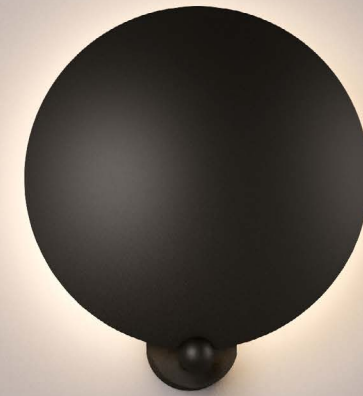

“The design of the Washington lamp was born from a gesture, like something obvious. A cupel balanced on a base, all linked by a ball joint.”

_ J.M. Wilmotte



Washington Family

Design J.M. Wilmotte, 1983

Disegnata nel 1983 dall'architetto Jean-Michel Wilmotte per l'Ambasciata francese di Washington DC., si adatta a qualsiasi contesto, dal soggiorno di casa all'ufficio, diffondendo una luce brillante e mirata.

Designed in 1983 by the French architect Jean-Michel Wilmotte for the French embassy in Washington D.C., it adapts to any context, from the living room at home to the office, diffusing a bright and focused light.

Dessinée en 1983 par l'architecte français Jean-Michel Wilmotte pour l'ambassade de France à Washington D.C., cette lampe s'adapte avec brio à tous les contextes, du salon à la maison au bureau, en diffusant une lumière vive et concentrée.

Design 1983 vom Architekten Jean-Michel Wilmotte für die französische Botschaft in Washington DC, passt sie zu jedem Kontext, vom Wohnzimmer bis zum Büro, indem sie ein helles und gezieltes Licht verbreitet.

Original photo of the French embassy by Wilmotte & Associés SAS d'Architecture

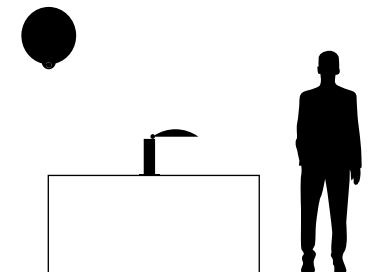

WASHINGTON WALL**Wall lamp**

-
Versione a parete della famosa lampada da tavolo disegnata da Jean-Michel Wilmotte realizzata in metallo e ottone. Sorgente LED integrata e alimentatore dimmerabile TRIAC. Disponibile in nero opaco, oro satinato o cromo.

-
Wall-mounted version of the iconic table lamp designed by Jean-Michel Wilmotte, crafted in metal and brass. Embedded LED light source dimmable TRIAC. Available in matte black, satin gold, or chrome finishes.

-
Version murale de la célèbre lampe de table conçue par Jean-Michel Wilmotte. Réalisée en métal et en laiton. Source LED intégrée et driver dimmable TRIAC. Disponible en noir mat, or satiné ou chrome.

-
Wandversion der berühmten Tischleuchte, von Jean-Michel Wilmotte entworfen, aus Metall und Messing gefertigt. Integrierte LED-Quelle und dimmbares TRIAC-Netzteil. Verfügbar in schwarz ft, satiniertem Gold oder Chrom.

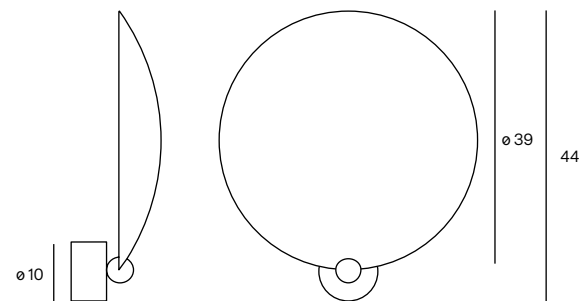

■ 102 Matte Black
 ■ 150 Chrome
 ■ 151 Satin Gold

LED 10W 900lm 2700K CRI>90
 Dimmable TRIAC

CE IP20



— Skylines Family

Design Ahlux

— Come esili fili nel cielo tessono geometrie essenziali. Rimandano alla materia e ai suoi immensi vuoti puntellati di luce. Skylines è una famiglia di lampade a sospensione, soffitto e parete composta da sottili tubi metallici intervallati da corpi illuminanti lineari.

— Like slender threads in the sky, they weave essential geometries. They refer to matter and its immense voids dotted with light. Skylines is a family of pendant, ceiling and wall lamps composed of thin metal tubes interspersed with linear light fittings.

— Comme de fins fils dans le ciel, ils tissent des géométries essentielles. Ils font référence à la matière et à ses immenses vides constellés de lumière. La famille Skylines regroupe des suspensions, des plafonniers et des appliques composées de tubes en métal fins entrecoupés de corps lumineux linéaires.

— Wie zarte Fäden am Himmel flechten sie essentielle Geometrien. Sie erinnern an Materie und ihre unendliche von Licht durchzogene Leere. Skylines ist eine Kollektion von Pendel-, Decken- oder Wandlampen, die aus dünnen Metallrohren besteht, welche von linearen Lichtkörpern unterbrochen werden.

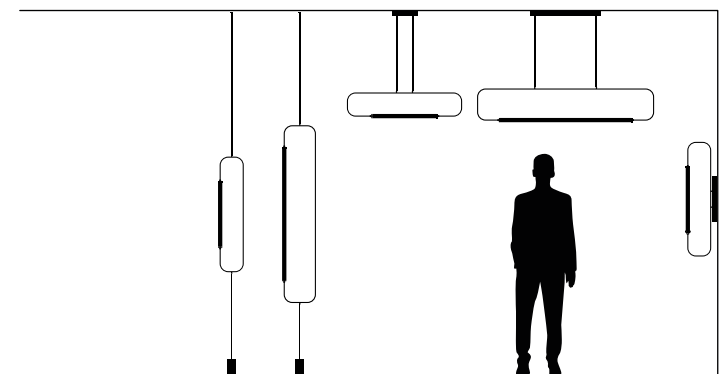

SKYLINES WALL-CEILING

Wall lamp



- Lampada da parete realizzata in metallo con diffusore in vetro Pyrex cannettato. Sorgente LED integrata e alimentatore elettronico dimmerabile DALI/PUSH. Finitura in nero ft con dettagli in ottone.

- Wall lamp made of metal with a fluted Pyrex glass diffuser. Integrated LED source and dimmable DALI/PUSH power supply. Finish in black ft with brass details.

- Applique murale en métal avec diffuseur en verre Pyrex cannelé. Source LED intégrée et alimentation dimmable DALI/PUSH. Finition noir ft avec détails en laiton.

- Wandlampe aus Metall mit einem Lampenschirm aus geriffeltem Pyrex-Glas. Integrierte LED-Quelle und dimmbares elektronisches Netzteil DALI/PUSH. Ausführung in schwarz ft mit Messingdetails.

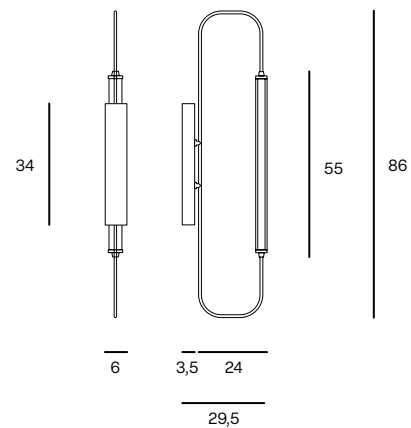

■ 103 Black FT + ■ 152 Satin Brass

LED 24W 3120lm 2700K CRI>90
Dimmable Dal/Push

CE  Classe I IP20

Unit: cm



Minus

Design LCI.LAB

- Caratterizzata da una forma minimale e discreta, Minus si distingue per un design funzionale che sporge dalla parete. La sua luce potente e allo stesso tempo morbida e avvolgente si adatta a qualsiasi spazio.

- Characterized by a minimal and discreet shape, Minus features a functional design that extends from the wall. Its powerful yet gentle and enveloping light makes it suitable for any space.

- Caractérisée par une forme minimaliste et discrète, Minus se distingue par un design fonctionnel qui s'étend du mur. Sa lumière, à la fois puissante et douce, s'adapte à tous les intérieurs.

- Mit ihrer minimalistischen und diskreten Form weist Minus ein funktionales Design auf, das sich von der Wand hinauslehnt. Ihr kraftvolles, aber gleichzeitig weiches und umhüllendes Licht passt sich jedem Raum an.

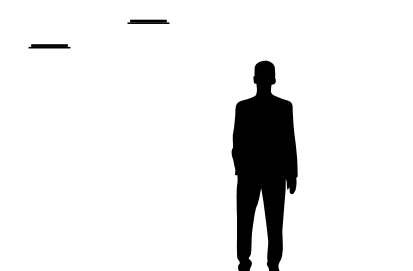

MINUS
Wall lamp



- Lampada da parete realizzata in alluminio pressofuso con diffusore in vetro sabbato. Sorgente LED integrata e alimentatore ON-OFF o dimmerabile DALI/PUSH. Disponibile in bianco ft, nero ft, bronzo verniciato e oro champagne.

- Wall lamp made of die-cast aluminum with a sandblasted glass diffuser. Embedded LED light source and ON-OFF or dimmable DALI/PUSH power supply. Available in white ft, black ft, painted bronze and champagne gold finishes.

- Applique murale en aluminium moulé sous pression avec diffuseur en verre sablé. Source lumineuse LED intégrée et alimentation ON-OFF ou dimmable DALI/PUSH. Disponible en blanc ft, noir ft, bronze peint et or champagne.

- Wandlampe aus Druckguss-Aluminium mit satiniertem Glasdiffusor. Integrierte LED-Quelle und ON-OFF oder dimmbares DALI/PUSH-Netzteil. Verfügbar in weiß ft, schwarz ft, lackierter Bronze und Champagner-Gold.

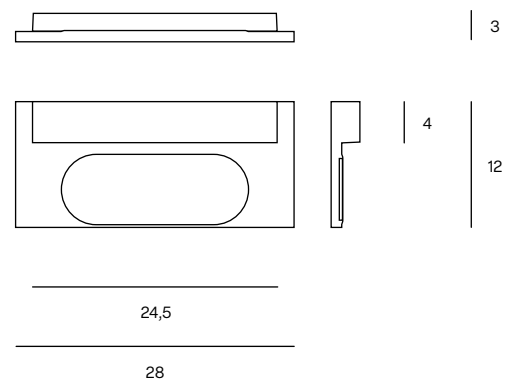

103 Black FT
105 White FT
175 Painted Bronze
177 Champagne Gold

LED 21W 2500lm 2700K CRI>90
LED 21W 2580lm 3000K CRI>90
ON-OFF or dimmable DALI/PUSH

CE Classe I IP20

Unit: cm



_ Zero Family



Zero Family

Design P. Cappello

- Disegnata da Paolo Cappello, la famiglia Zero si ispira al simbolo matematico per eccellenza creando un effetto essenziale, elegante e rifinito in ogni suo dettaglio.

- Designed by Paolo Cappello, the Zero family draws inspiration from the perfect mathematical symbol, creating an essential effect that is both elegant and perfectly refined in every detail.

- Dessinée par Paolo Cappello, la famille Zero s'inspire du symbole mathématique par excellence, obtenant un effet qui se veut essentiel, élégant et raffiné dans les moindres détails.

- Entwickelt von Paolo Cappello, lässt sich die Zero Family vom perfekten mathematischen Symbol inspirieren, um eine essenzielle Wirkung zu erzielen, die sowohl elegant als auch bis ins kleinste Detail perfekt ausgearbeitet ist.

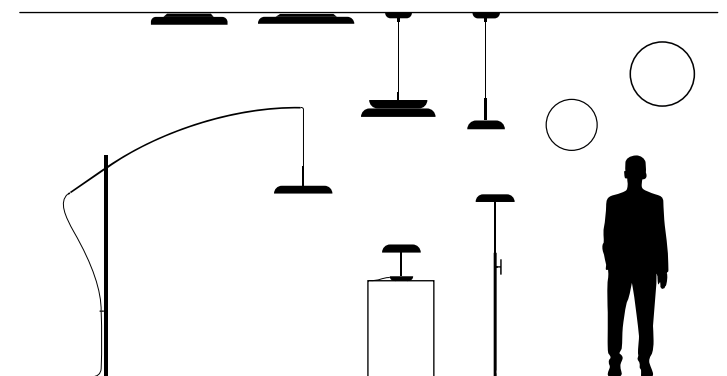

DOPPIO ZERO M - L
Suspension lamp



- Doppio Zero è un sistema di illuminazione che combina i vari modelli di Zero S - M - L. La lampada è disponibile nelle versioni composte da Zero S+M e Zero M+L. Sorgente LED integrata e alimentatore elettronico dimmerabile TRIAC. Disponibile nelle finiture total white, total black, total red brown e bronzo verniciato + oro champagne.

- Doppio Zero is a lighting system that combines various models of the Zero S, M, and L. The lamp is available in versions composed of Zero S+M and Zero M+L. Embedded LED source and TRIAC dimmable electronic power supply. Available in total white, total black, total red brown, painted bronze + champagne gold finishes.

- Doppio Zero est un système d'éclairage qui combine les différents modèles de Zero S - M - L. La lampe est disponible en versions composées de Zero S+M et Zero M+L. Source LED intégrée et driver dimmable TRIAC. Disponible dans les finitions total white, total black, total red brown et bronze peint + or champagne.

- Doppio Zero ist ein Beleuchtungssystem, das verschiedene Modelle der Zero S - M und L kombiniert. Die Lampe ist in den Versionen Zero S+M und Zero M+L verfügbar. Integrierte LED-Quelle und dimmbares elektronisches TRIAC-Netzteil. Farbvarianten: Total White, Total Black, Total Red Brown ft und lackierte Bronze + Champagner-Gold.

DOPPIO ZERO M
Suspension lamp

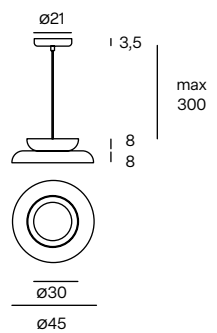

103 Black FT (Total Black)
 105 White FT (Total White)
 138 Red-Brown FT (Total Red-Brown)
 177 Champagne Gold + 175 Painted Bronze
 LED SMD 43W 3170lm 2700K CRI>90
 LED SMD 43W 3300lm 3000K CRI>90
 Dimmable TRIAC
 CE Classe I IP20

Unit: cm

DOPPIO ZERO L
Suspension lamp

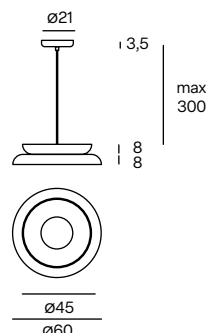

103 Black FT (Total Black)
 105 White FT (Total White)
 138 Red-Brown FT (Total Red-Brown)
 177 Champagne Gold + 175 Painted Bronze
 LED SMD 76W 5476lm 2700K CRI>90
 LED SMD 76W 5700lm 3000K CRI>90
 Dimmable TRIAC
 CE Classe I IP20

Unit: cm



Colours & Finishes

VERNICIATURA

VARNISH

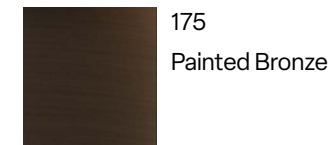
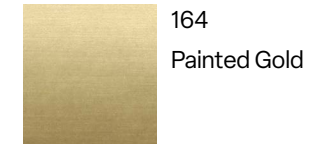
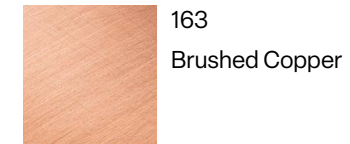
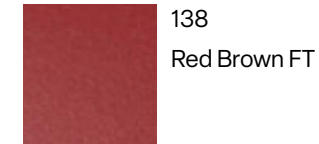
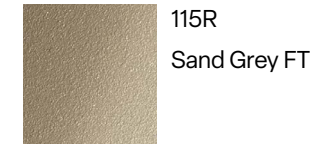
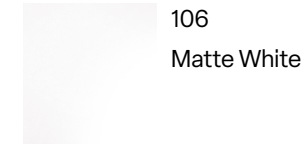
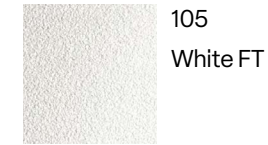

ANODIZZATI

ANODIZED

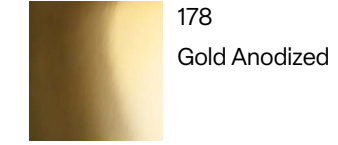
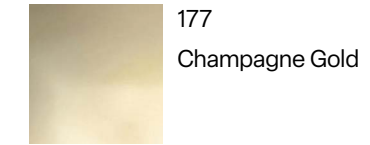
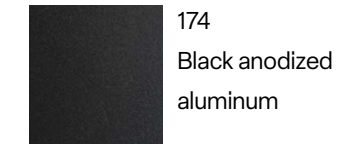
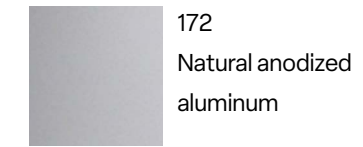

GALVANICA

GALVANIC

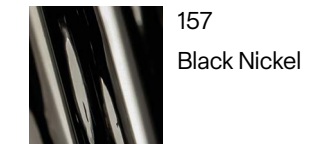
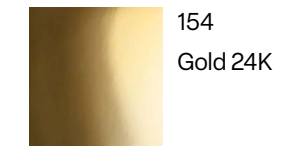
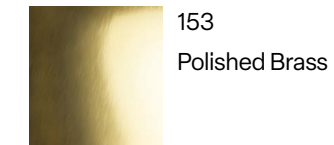
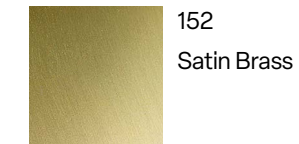
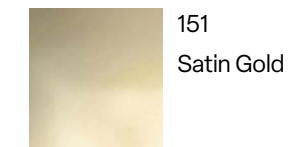
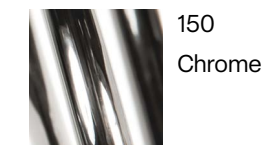

TESSUTO

TEXTILE

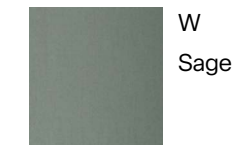
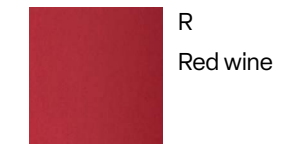
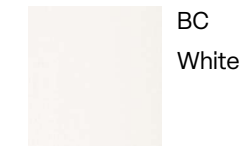

VETRO

GLASS

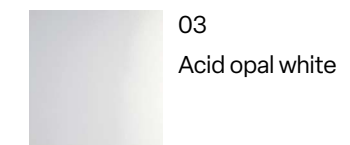

LEGNO

WOOD

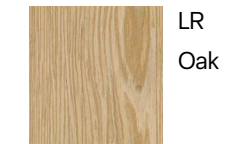
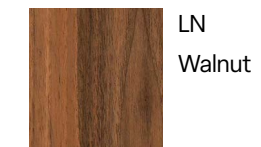

MARMO

MARBLE

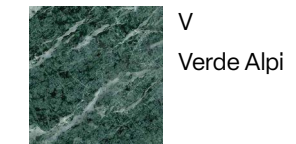
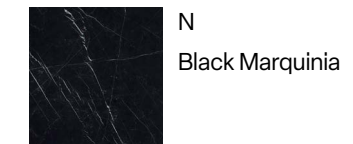

All LUMEN CENTER products that are part of the scope of the European low voltage directive BT 73/23 and consecutive amendment 93/68, meet the necessary requirements and bear the CE labeling. All dimensions are in cm unless otherwise indicated in the technical sheet. The assembly and maintenance instructions are included in the packages, as well as all certificates and warranty conditions. The indications about the materials and the finishes only refer to the main visible parts of the products. In general, the products are supplied without bulbs, unless otherwise indicated in the price list. LUMEN CENTER Italia Srl reserves the right to make any technical or formal modifications to the products contained in the catalogue, without any notice. All the data related to the bright efficiency emitted by our devices, are nominal and concerning to the specific technics of our bright sources (LED, halogen and fluorescent lamps) declared by the producer. The data of effective consumption and luminous emission, based on electric characteristics (potential differences and power supplies, dimming etc.) on physic and aesthetic of the devices (colour, material, type etc.) will be provided on customers demand.

Tutti i prodotti LUMEN CENTER che rientrano nell'ambito di applicazione della direttiva europea bassa tensione B.T. 73/23 e successiva modifica 93/68, soddisfano ai requisiti richiesti e recano la marcatura CE. Tutte le dimensioni sono espresse in cm salvo se diversamente indicato nella scheda tecnica. Le istruzioni di montaggio e di manutenzione sono incluse negli imballi, così come i certificati e le condizioni di garanzia. Le indicazioni relative a materiali e finiture riguardano solo le parti principali visibili dei prodotti. Generalmente i prodotti sono forniti senza lampadina salvo se diversamente indicato nel listino prezzi. LUMEN CENTER Italia Srl si riserva di apportare qualsiasi modifica tecnica o formale ai prodotti a catalogo senza dovere di preavviso. Tutti i dati relativi all'efficienza luminosa emessa dai nostri apparecchi, sono da intendersi nominali e riferiti alle specifiche tecniche delle sorgenti luminose (lampade a LED, alogene e fluorescenti) dichiarate dal costruttore. I dati di effettivo consumo ed emissione luminosa, basati sulle caratteristiche elettriche (tensioni e correnti di alimentazione, dimmerabilità ecc.), fisiche ed estetiche degli apparecchi (colore, materiale, tipologia ecc.), verranno fornite al cliente su specifica richiesta.

**Lumen
center.**

Lumen Center Italia Srl
SEDE OPERATIVA
Via Donatori del Sangue, 37
20010 Santo Stefano Ticino (MI), Italy
Ph. (+39) 02 36544811
info@lumencenteritalia.com

SALES DEPARTMENT
tel. (+39) 02 3654 4310
sales@lumencenteritalia.com

GRAPHIC DESIGN & ART DIRECTION
Erika Nicole Visintin

LOGO
VZN Studio

3D IMAGES & PHOTOS
Zonelab
Wilmotte & Associés
Photo editing: Erika Nicole Visintin

COPYWRITING
Erika Nicole Visintin

TRANSLATION
DE_ Chiara Ballabio

January 2025

