

DOOR
HANDLE
DESIGN



groël



RUSTIC DOOR HANDLES
MANILLAS RÚSTICAS

● ● BEL.LA 108



**Quality and appeal,
a true classic remains
ageless over time**

Classic, rustic and powerful
in design, with a unique
porcelain grip of the highest
quality.

**Calidad y atracción,
un verdadero clásico
no envejece frente
al tiempo**

De diseño clásico, rústico
y poderoso, con una
empuñadura única en
porcelana de máxima
calidad.

*TD 262





MARÍA 803

**It's all about aesthetics, the nature
of beauty and good taste**

Proportioned handle that makes tradition with
reminiscence of a golden era.

**La estética lo es todo, la naturaleza
de la belleza y el buen gusto**

*Proporcionada manilla que hace tradición con
reminiscencias a una época dorada.*



*TD 313





DEV 808



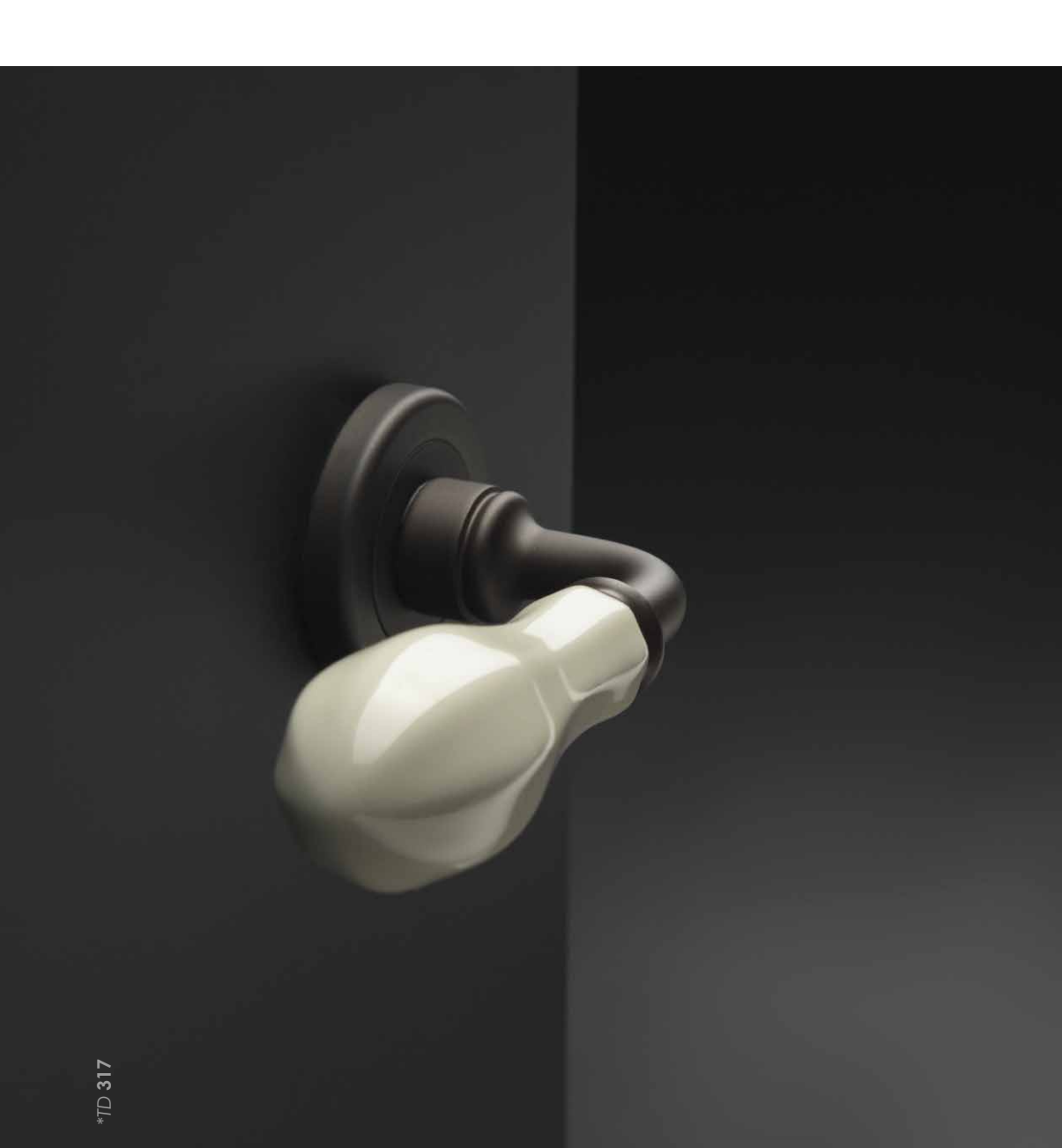

*TD 317

Classic and distinguished, a world of reminiscences

A charming pearl effect owing to its porcelain grip, an authentic jewel.

Clásica y distinguida, un mundo de reminiscencias

Un efecto de perla embaucadora por su empuñadura en porcelana, una auténtica joya.



KILTO 809



*TD 318

Transcending time and fashion

A perfect fit for classic and modern environments. Standing out for providing that traditional detail that completes the conventional design.

Trascendiendo el tiempo y las modas

Encaja a la perfección en ambientes clásicos y modernos. Destaca por aportar ese detalle tradicional que completa el diseño convencional.





TECH DATA
INFO TÉCNICA

BEL.LA 108



*R 207

LPBL



LPMF



BOBL



AQBL



BOMF



AQMF



BOCRAQ



AQCRAQ



Rose
Roseta

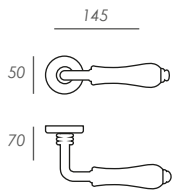

RT

Narrow Rose
Roseta Estrecha

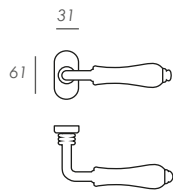

RE

Escutcheon
Bocallave

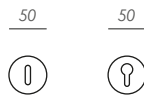

RTBB



RTB

WC Set
Condena



RTCD

Window Handle
Grisán

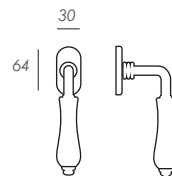

G

Oval Backplate
Placa Oval

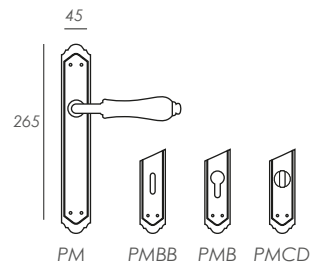

PM

PMBB

PMB

PMCD



FUBL



HIBL



FUCRAQ



HICRAQA



MARÍA 803



LP



AQ



BO



FU



HI



*R 209

Rose
Roseta

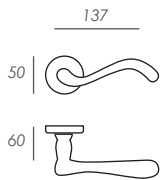

RT

Narrow Rose
Roseta Estrecha

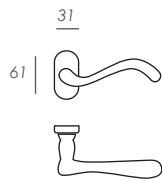

RE

Escutcheon
Bocallave

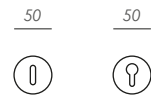

RTBB

RTB

WC Set
Condensa



RTCD

Window Handle
Grisán

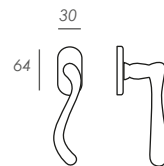

G

María Backplate
Placa María

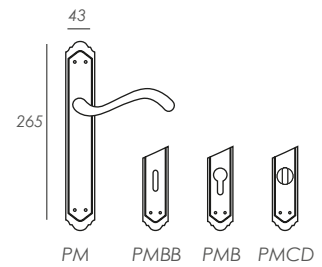

PM

PMBB

PMB

PMCD



LPBL



LPMF



MRBL



MRMF

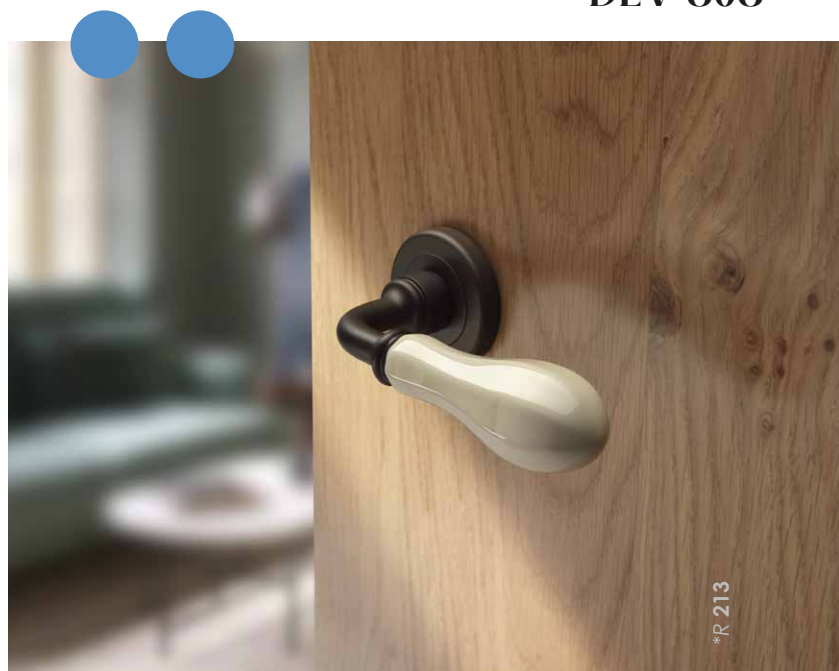

*R 213

Rose
Roseta

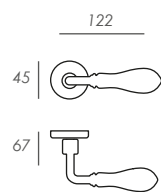

RK

Narrow Rose
Roseta Estrecha

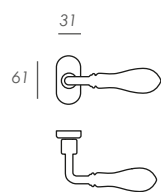

RE

Escutcheon
Bocallave

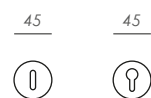

RKBB

RKB

WC Set
Condena



RKCD

Window Handle
Grisán

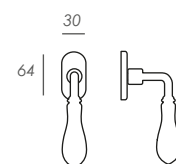

G

Oval Backplate
Placa Oval

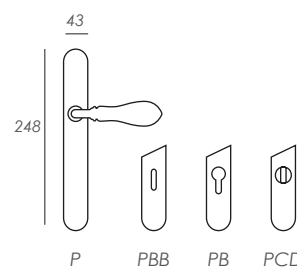

P

PBB

PB

PCD

KILTO 809

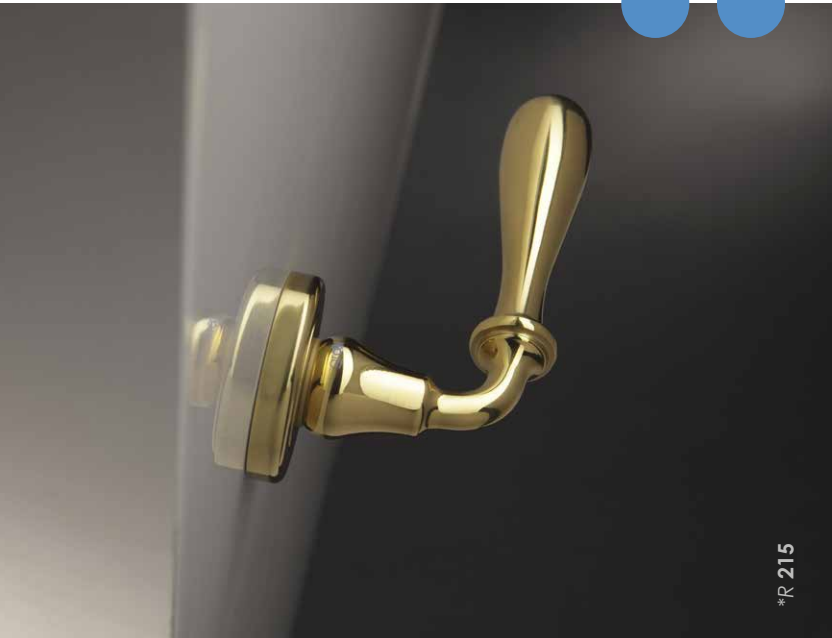

LP



OB



AQ



MR



HI



Rose
Roseta

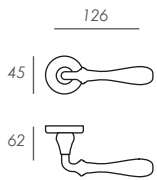

RK

Narrow Rose
Roseta Estrecha

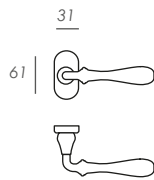

RE

Escutcheon
Bocallave

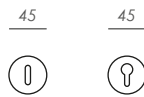

RKBB

RKB

WC Set
Condena



RKCD

Window Handle
Grisán

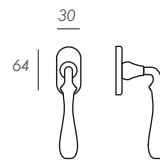

G

Oval Backplate
Placa Oval

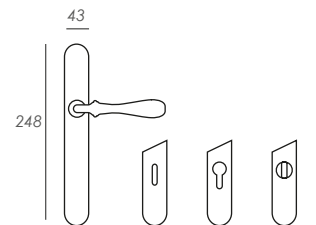

P

PBB

PB

PCD

INSTALLATION INSTRUCTIONS

INSTRUCCIONES DE MONTAJE

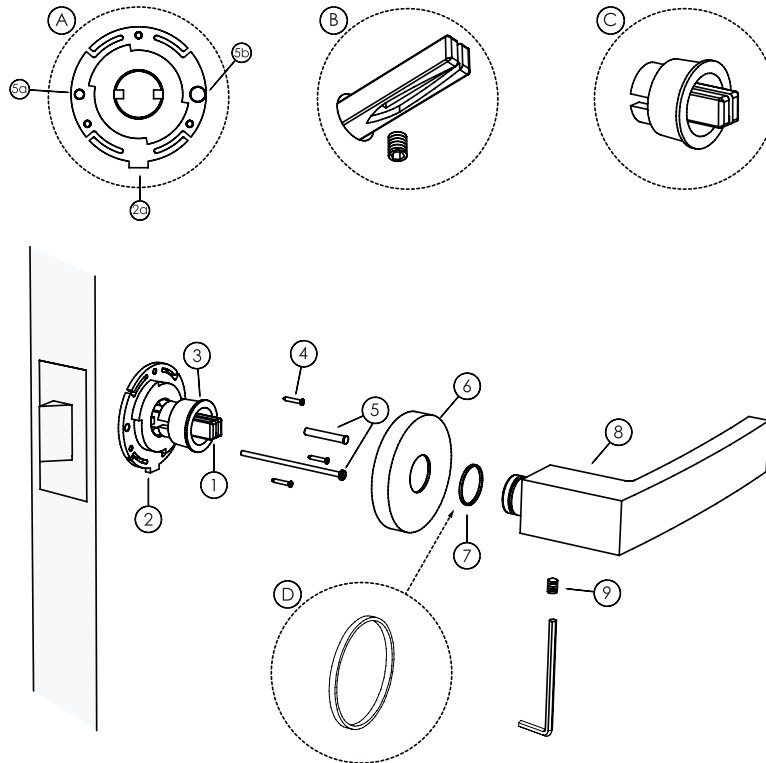

1. Insert the spindle (1) in the lock. Follow position shown on fig.B relative to the allen screw (9).
2. Place the inner ring (2) in the right position fig.A. The flap (2a) must point to the ground.
3. Use the plastic piece (3) to centre the inner ring (fig.C).
4. Screw the inner ring with the supplied screws (4).
5. (Optional) Use the through bolt screws (5) as shown in fig.A. Hole (5a) for male and (5b) for female.
6. Remove the plastic piece used to centre the inner rose.
7. Adjust the rose (6). The notch (6a) must be inserted on the flap (2a).
8. Insert the plastic ring (7) -fig.D- in the door handle neck to avoid any scratch when operating.
9. Place the door handle (8) and fix it to the spindle(fig.B) with the allen screw (9).

1. Introducir el cuadradillo (1) en la cerradura según posición de la fig.B respecto al tornillo allen (9).
2. Colocar el interno (2) en la posición de la fig.A. La muesca (2a) debe apuntar al suelo.
3. Usar la pieza plástica (3) para centrar el interno (fig.C).
4. Atornillar el interno con los tornillos suministrados (4).
5. (Opcional) Colocar los tornillos pasantes (5) según figura fig.A. Agujero (5a) macho y (5b) hembra.
6. Quitar la pieza plástica usada para centrar la roseta.
7. Colocar la roseta (6). Debe encajar el rebaje (6a) con la pestaña (2a).
8. Insertar la arandela de plástico (7) -fig.D- en el cuello de la manilla para evitar roces al accionar.
9. Colocar la manilla (8) y fijarla al eje (fig.B) con el tornillo allen (9)

MAINTENANCE MANTENIMIENTO

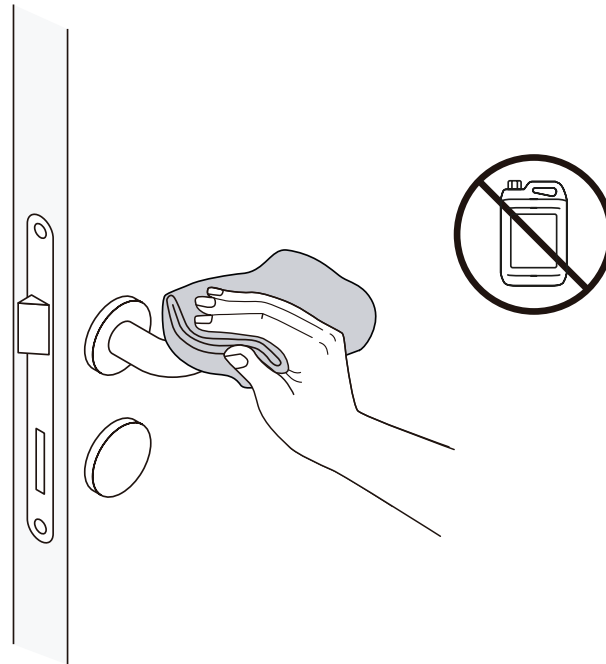

Clean with a dry cloth.
Do not use brass cleaner
as it might affect the protective coating.

Note: Handles vary by style
but maintenance is the same for all of them.

*Limpiar con un paño seco.
No usar productos químicos o abrasivos,
pueden dañar la capa protectora.*

*Nota: Los modelos pueden variar
pero no así el mantenimiento.*



 groel.es