

DURAME[®]

CONTEMPORARY WOOD
HOME COLLECTION



CONTEMPORARY WOOD
HOME COLLECTION

mobili e complementi d'arredo

DURAME®

Durame è il risultato dell'unione tra la grande passione per la lavorazione del legno, tramandata da generazioni, e il desiderio di dare forma a idee e pensieri nuovi, aggiornati e al passato coi tempi. Ecco allora una collezione dalle connotazioni sperimentali, composta da oggetti unici, carichi di significato, ognuno con una personalità precisa e distinta, che esprimono a pieno i valori dell'alto artigianato italiano e le infinite potenzialità del più antico materiale da costruzione.

Durame is the result of the union between the great passion for wood carving, transmitted from age to age, and the desire to shape new and fresh ideas and thoughts. So here it is, a series of unique objects characterized by experimental and meaningful connotations. Each one of them has a different meaning and a precise personality that fully expresses the values of the noble Italian craftsmanship and the limitless potential of the oldest building material.

contemporary wood

La cura del particolare, la grande abilità artigiana, la ricerca e la valorizzazione della materia sono state componenti di rilievo nella progettazione e realizzazione dei pezzi che compongono la collezione **Durame**, creati avvalendosi della collaborazione di designer dal gusto colto e raffinato.

La gamma include contenitori, sedute, tavoli e oggettistica funzionale; tutti elementi dal carattere contemporaneo, accomunati dalla forte presenza del legno, espressione di naturalità e bellezza, ma caratterizzati ognuno da uno stile personale, eclettico ed inusuale, grazie a lavorazioni che esaltano le sfumature estetiche del legno stesso, ad accostamenti inediti di materiali diversi e alla ricerca del dettaglio e della finitura non scontata.

The care for the detail, the great handmade skill, the research and the enhancement of the material were important elements during the planning and the creation of the articles that are part of the Durame collection. These pieces were created in collaboration with designers with a refined and cultured taste. The collection includes containers, seats, tables and accessories; all these elements have a contemporary personality and are characterised by the strong presence of wood. Thanks to the manufacturing that intensifies wood's aesthetic shades and thanks to the unusual pulling together of different materials, every single piece expresses authenticity, beauty and has its own eclectic and unusual style. The search for the detail and for the unexpected finishing, makes our products even more valuable.

DURAME[®]





“ In tutte le cose
della natura esiste qualcosa
di meraviglioso. ”
Aristotele

*“In all things
there is something of nature
of wonderful.”
Aristotele*



DURAME[®]

CONTENITORI

STORAGE UNITS

BRIDGE 2

design: Paolo Salvadè



MADIA

Mobile contenitore in legno con due ante in cristallo e maniglia in legno massello. Il top è in legno o in gres porcellanato e il basamento in metallo. La ripartizione interna è caratterizzata da ripiani in legno, cassetto (a scelta) con frontale come il top e illuminazione a led.

Dimensioni:
L 104 x P 50 x H 158,5 cm
(H piano 153 cm)

Materiali:
Struttura: legno massello e tranciato di noce canaletto / rovere / rovere nero.
Piano: legno massello e tranciato di noce canaletto / rovere / rovere nero / gres porcellanato.
Ante: legno massello e tranciato di noce canaletto / rovere / rovere nero / vetro con cornice di legno.
Gambe: metallo laccato bronzo

SIDEBOARD

Cupboard in wood with two glass doors and solid wood handle. The top is in wood or porcelain stoneware and the base in metal. The internal division is characterized by wooden shelves, drawer (optional) with front as the top and led lighting.

Dimensions:
L 104 x W 50 x H 158,5 cm
(H top 153 cm)

Materials:
Structure: solid wood walnut veneer / solid wood oak veneer / solid wood black oak.
Top: solid wood walnut veneer / solid wood oak veneer / solid wood black oak / porcelain stoneware.
Doors: solid wood walnut veneer / solid wood oak veneer / solid wood black oak / glass with wooden frame.
Legs: bronze lacquered metal





BRIDGE 3 BRIDGE 4

design: Paolo Salvadè

MADIA

Mobile contenitore in legno con tre/quattro ante in legno e cristallo, con maniglia in legno massello. Il top è in legno o in gres porcellanato e il basamento in metallo. La ripartizione interna è caratterizzata da ripiani in legno, cassetto (a scelta) con frontale come il top e illuminazione a led.

Dimensioni:

L 156 x P 50 x H 80,5 cm - (H piano 74,5 cm)
L 208 x P 50 x H 80,5 cm - (H piano 74,5 cm)

Materiali:

Struttura: legno massello e tranciato di noce canaletto / rovere / rovere nero.
Piano: legno massello e tranciato di noce canaletto / rovere / rovere nero / gres porcellanato.
Ante: legno massello e tranciato di noce canaletto / rovere / rovere nero / vetro con cornice di legno.
Gambe: metallo laccato bronzo



SIDEBOARD

Cupboard in wood with three/four wooden and crystal doors, with solid wood handle. The top is in wood or porcelain stoneware and the base in metal. The internal division is characterized by wooden shelves, drawer (optional) with front as the top and led lighting.

Dimensioni:

L 156 x W 50 x H 80,5 cm - (H top 74,5 cm)
L 208 x W 50 x H 80,5 cm - (H top 74,5 cm)

Materiali:

Structure: solid wood walnut veneer / solid wood oak veneer / solid wood black oak.
Top: solid wood walnut veneer / solid wood oak veneer / solid wood black oak / porcelain stoneware.
Doors: solid wood walnut veneer / solid wood oak veneer / solid wood black oak / glass with wooden frame.
Legs: bronze lacquered metal









HONEY 2

design: Alessandro Elli

MOBILE CONTENITORE

Mobile contenitore con ante e/o ribalta in legno e piano in marmo o legno. Il basamento è in metallo e la ripartizione interna è caratterizzata da ripiani in legno.

Dimensioni:
L 120 x P 50 x H 150 cm

Materiali:
Struttura: legno massello e tranciato di noce canaletto / rovere / rovere nero.
Piano: marmo.
Ante: legno massello e tranciato di noce canaletto / rovere / rovere nero.
Gambe: metallo laccato bronzo / canna di fucile



CABINET

Storage unit with wooden doors and/or flap and marble or wooden top. The base is in metal and the internal division is characterized by wooden shelves.

Dimensions:
L 120 x W 50 x H 150 cm

Materials:
Structure: solid wood walnut veneer / solid wood oak veneer / solid wood black oak.
Top: marble.
Doors: solid wood walnut veneer / solid wood oak veneer / solid wood black oak / glass with wooden frame.
Legs: bronze lacquered metal / gunmetal lacquered









HONEY 3 HONEY 4

design: Alessandro Elli

MADIA

Mobile contenitore con tre/quattro ante in legno e piano in marmo o legno. Il basamento è in metallo e la ripartizione interna è caratterizzata da ripiani in legno.

Dimensioni:
L 170 x P 50 x H 73 cm
L 220 x P 50 x H 73 cm

Materiali:
Struttura: legno massello e tranciato di noce canaletto / rovere / rovere nero.
Piano: marmo.
Ante: legno massello e tranciato di noce canaletto / rovere / rovere nero.
Gambe: metallo laccato bronzo / canna di fucile

SIDEBOARD

Storage unit with three/four wooden doors and marble or wooden top. The base is in metal and the internal division is characterized by wooden shelves.

Dimensions:
L 170 x W 50 x H 73 cm
L 220 x W 50 x H 73 cm

Materials:
Structure: solid wood walnut veneer / solid wood oak veneer / solid wood black oak.
Top: marble.
Doors: solid wood walnut veneer / solid wood oak veneer / solid wood black oak / glass with wooden frame.
Legs: bronze lacquered metal / gunmetal lacquered

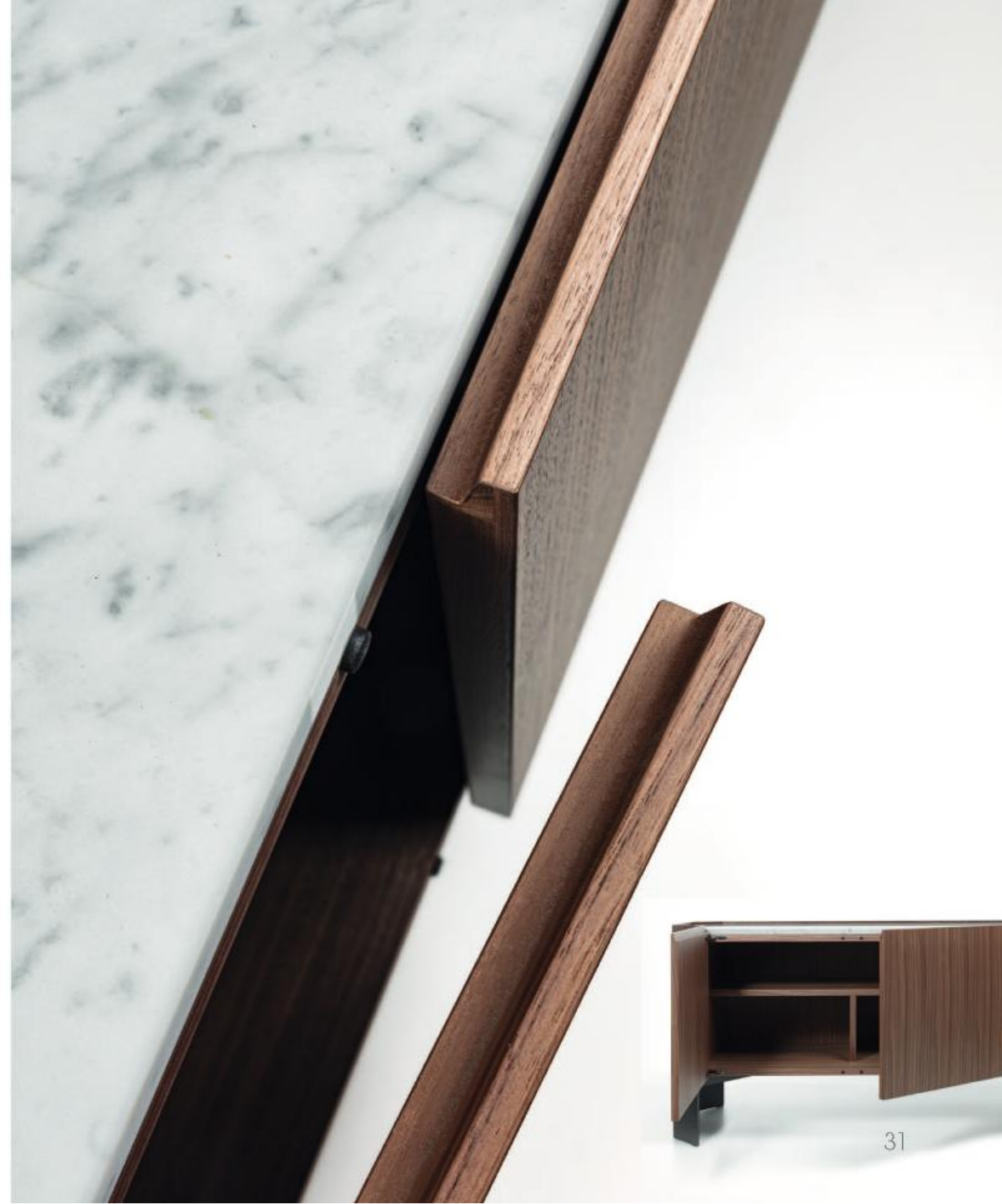





CRAB

design: Maurizio Di Lauro

MADIA

Mobile contenitore in legno con ante in legno, di cui una rivestita in ottone o gres porcellanato. Il top è in legno o in gres porcellanato e il basamento in legno massello. La ripartizione interna è caratterizzata da ripiani in legno.

Dimensioni:

L 174 x P 48 x H 73 cm
L 174 x P 48 x H 82 cm
L 174 x P 55 x H 73 cm
L 174 x P 55 x H 82 cm
L 200 x P 48 x H 73 cm
L 200 x P 48 x H 82 cm
L 200 x P 55 x H 73 cm
L 200 x P 55 x H 82 cm

Materiali:

Struttura: legno massello e tranciato di noce canaletto / rovere / rovere nero / palissandro.
Piano: legno massello e tranciato di noce canaletto / rovere / rovere nero / palissandro / gres porcellanato.
Ante: legno legno massello e tranciato di noce canaletto / rovere / rovere nero / palissandro / ottone / gres porcellanato



SIDEBOARD

Wooden storage unit with wooden doors, one of which is covered in brass or porcelain stoneware. The top is in wood or porcelain stoneware and the base in solid wood. The internal division is characterized by wooden shelves.

Dimensioni:

L 174 x W 48 x H 73 cm
L 174 x W 48 x H 82 cm
L 174 x W 55 x H 73 cm
L 174 x W 55 x H 82 cm
L 200 x W 48 x H 73 cm
L 200 x W 48 x H 82 cm
L 200 x W 55 x H 73 cm
L 200 x W 55 x H 82 cm

Materiali:

Structure: solid wood and canaletto walnut veneer / solid wood and oak veneer / solid wood and black oak veneer / solid wood and rosewood veneer.
Top: solid wood and canaletto walnut veneer / solid wood and oak veneer / solid wood and black oak veneer / solid wood and rosewood veneer / porcelain stoneware.
Doors: solid wood and canaletto walnut veneer / solid wood and oak veneer / solid wood and black oak veneer / solid wood and rosewood veneer / brass / porcelain stoneware





CRAB ALTO

design: Maurizio Di Lauro

MOBILE CONTENITORE

Mobile contenitore in legno con quattro ante in legno e un cassetto rivestito in ottone o gres porcellanato. Il Basamento è in legno massello. La ripartizione interna è caratterizzata da ripiani.

Dimensioni:

L 105 x P 48 x H 162 (basso)
L 105 x P 48 x H 171,5 cm (alto)

Materiali:

Struttura: legno massello e tranciato di noce canaletto / rovere / rovere nero / palissandro.
Ante: legno legno massello e tranciato di noce canaletto / rovere / rovere nero / palissandro.
Cassetto: ottone / gres porcellanato



CABINET

Wooden storage unit with four wooden doors and a drawer covered in brass or porcelain stoneware. The base is in solid wood. The internal division is characterized by shelves.

Dimensions:

L 105 x W 48 x H 162 cm (low)
L 105 x W 48 x H 171,5 cm (High)

Materials:

Structure: solid wood and canaletto walnut veneer / solid wood and oak veneer / solid wood and black oak veneer / solid wood and rosewood veneer.
Doors: solid wood and canaletto walnut veneer / solid wood and oak veneer / solid wood and black oak veneer / solid wood and rosewood veneer.
Drawer: brass / porcelain stoneware



BREATHE

design: Studio BAAG

MOBILE CONTENITORE

Un mobile contenitore con una superficie epidermica. Pori che traspirano una sensualità velata, quasi nascosta. Un invito ad un'esperienza tattile ed esplorativa. Punti di colore e dettagli sobri e raffinati decorano un volume semplice ma scultoreo. Mobile contenitore a due ante in legno massello con ripiani interni e basamento in metallo verniciato.

Dimensioni:
L 80 x P 40 x H 156 cm

Materiali:
Legno massello e tranciato di noce canaletto / rovere / rovere nero / castagno;
Ferro laccato: blu / verde / bronzato
(altri colori a richiesta)



CABINET

A cabinet with an epidermal surface. Pores that transpire a veiled sensuality. An invitation to a tactile and exploratory experience. Points of colour and refined details adorn a simple but sculptural volume. Storage unit with two doors in solid wood with internal shelves and lacquered metal base.

Dimensions:
L 80 x W 40 x H 156 cm

Materials:
Solid canaletto walnut and veneer wood / solid oak and veneer wood / solid black oak and veneer wood / solid chestnut and veneer wood;
Lacquered metal: blue / green / bronzed (other colors on request)



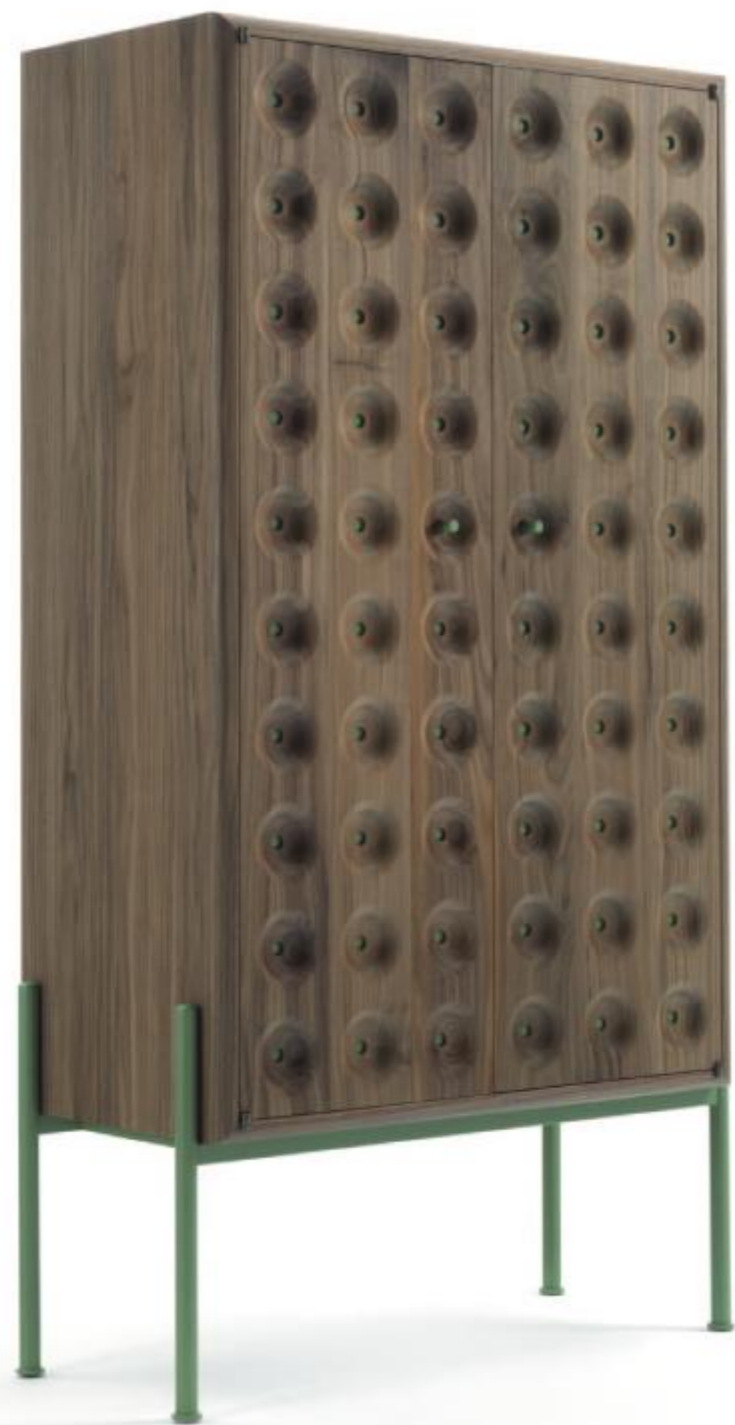

SINGOLO

design: Maurizio Di Lauro

LIBRERIA

Libreria modulare in legno massello in varie altezze.

Una libreria che può essere utilizzata a parete o per dividere due ambienti.

Leggerezza e matericità si fondono per dare vita ad un oggetto che va oltre il semplice mobile in cui riporre dei libri: SINGOLO è una sorta di facciata architettonica, una boiserie tridimensionale.

Dimensioni:

L 78 x P 16 x H 104 cm (S)
L 78 x P 16 x H 210 cm (M)
L 78 x P 16 x H 240 cm (L)
L 78 x P 16 x H 266 cm (XL)
L 78 x P 16 x H 296 cm (XXL)

Materiali:

Legno massello di noce canaletto / rovere / rovere nero;
Ottone satinato



BOOKCASE

Modular bookcase in solid wood in various heights.

A bookcase that can be placed against the wall or to divide two areas.

Lightness and materiality melt to create an object that is much more than a simple furniture for storing books.

SINGOLO is a sort of an architectural facade, a three-dimensional boiserie.

Dimensions:

L 78 x W 16 x H 104 cm (S)
L 78 x W 16 x H 210 cm (M)
L 78 x W 16 x H 240 cm (L)
L 78 x W 16 x H 266 cm (XL)
L 78 x W 16 x H 296 cm (XXL)

Materials:

Solid canaletto walnut wood / Solid oak wood / Solid black oak wood;
Satin-finish brass

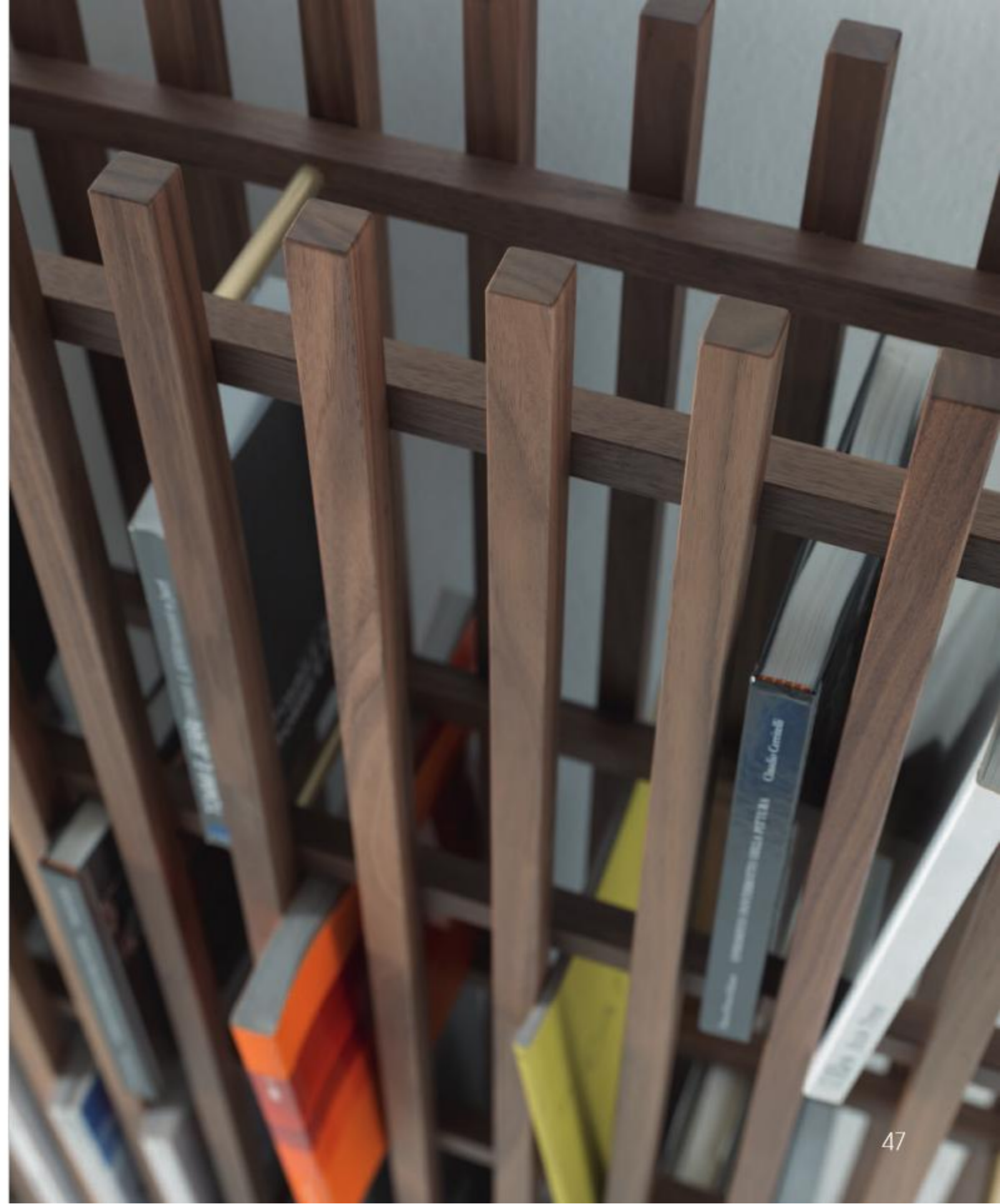



TOFANE

design: Alessandro Elli

LIBRERIA

Mobile/Libreria in legno massello di varie dimensioni, avente ripiani in cristallo.

Dimensioni:
L 160 x P 40 x H 176 cm
L 57 x P 40 x H 176 cm
L 57 x P 40 x H 130,5 cm

Materiali:
Legno massello di noce canaletto / rovere / rovere nero / frassino nero;
Ripiani: cristallo extrachiaro / cristallo bronzato



BOOKCASE

Solid wood bookcase of various sizes, with glass shelves.

Dimensions:
L 160 x W 40 x H 176 cm
L 57 x W 40 x H 176 cm
L 57 x W 40 x H 130,5 cm

Materials:
Solid walnut wood / solid oak wood / solid black oak wood / solid black ash wood;
Shelves: extra clear glass / bronzed glass







ELLA

design: Federico Biosi

MADIA

Mobile contenitore a due ante in legno con base in legno e ottone. Una madia caratterizzata da un chiaro rimando al mondo sartoriale: la lavorazione a fresatura su legno, crea un effetto plissettato con andamento graduale sui pannelli che ne compongono le superfici verticali.

Dimensioni:
L 118 x P 46 x H 97,5 cm
L 118 x P 49 x H 97,5 cm (Bifacciale)

Materiali:
Struttura: legno massello e tranciato di noce canaletto / rovere / ottone bronzato / ottone satinato;
Ripiani interni in legno o cristallo



SIDEBOARD

Storage unit with two wooden doors with wooden and brass base. A sideboard characterized by a clear reference to the sartorial reality: the milling machine makes the timber look gradually pleated on the panels which compose its vertical surfaces.

Dimensioni:
L 118 x W 46 x H 97,5 cm
L 118 x W 49 x H 97,5 cm (Bifacial)

Materials:
Structure: solid wood walnut veneer / solid wood oak veneer / bronzed brass / satin-finish brass;
Wood or crystal internal shelves



SIPARIO

design: Cristina Celestino

MOBILI CONTENITORI

Mobile contenitore in legno con ante e ripiano interno in cristallo. La base in legno massello con ripiano in legno è nascosta da passamaneria tripolino.

SIPARIO rappresenta la messa in scena progettuale dell'atmosfera che si respira calcando il palcoscenico dei teatri storici. L'ispirazione nasce da uno studio del teatro all'italiana: emiciclo ligneo, quinte prospettiche e scena profonda.

Dimensioni:
Cabinet basso L 140 x P 45 x H 94 cm
Cabinet alto L 80 x P 45 x H 160

Materiali:
Legno massello e tranciato di noce canaletto / rovere / rovere nero;
Ripiano interno in cristallo;
Frange tripolino verde bosco / verde cipresso / pervinca / rosa antico e possibili colori a richiesta



CABINETS

Storage unit in wood with doors and internal glass shelf. The solid wood base with wooden shelf is hidden by Tripolino passamaneria. SIPARIO represents the planning mise-en-scène that can breathe treading the boards of an historical theatre. The inspiration arises from a study about Italian theatres: a wooden semi cycle, perspectival off-stages and a deep scenery.

Dimensions:
Low Cabinet L 140 x W 45 x H 94 cm
High Cabinet L 80 x W 45 x H 160

Materials:
solid wood walnut veneer / solid wood oak veneer / solid wood black oak;
Crystal internal shelf;
Tripoline fringes forest green / cypress green / periwinkle / antique pink and other colours on demand





GROW

design: Paolo Salvadè

LIBRERIA

Libreria in legno massello con mensole in metallo.
Una fusione perfetta di due materiali; una forma sagomata in legno massello e alzatine metalliche compongono un totem scultoreo con sviluppo verticale, dove esporre oggetti o riporre libri.

Dimensioni:
L 55 x P 55 x H 220 cm
L 55 x P 55 x H 180 cm

Materiali:
Struttura: legno massello di noce canaletto / rovere / rovere nero / larice;
Mensole e basamento: Ferro bronzato / Ferro cerato



BOOKCASE

Solid wood bookcase with metal shelves.
A perfect fusion of two materials; a solid wood contoured shape and metal backslashes compose a sculptural totem with a vertical development, where exhibiting objects or storing books.

Dimensions:
L 55 x P 55 x H 220 cm
L 55 x P 55 x H 180 cm

Materials:
Structure: solid walnut wood / solid oak wood / solid black oak wood / solid larch wood;
Shelves and base: bronzed metal / waxed metal





CAMINETTO

design: Dmitry Kozinenko

MOBILE CONTENITORE

Mobile Contenitore in legno, con ripiani in cristallo.
Un'idea nata dal tentativo di osservare da un'angolazione diversa gli oggetti familiari che ci circondano. Un mobile contenitore luminoso che è metafora del focolare domestico.

Dimensioni:
L 70 x P 45 x H 220 cm

Materiali:
Legno di rovere / rovere grigio / noce canaletto;
Fondale laccato rosso o naturale;
Ripiani interni in cristallo;
Basamento: metallo laccato



CABINET

Wooden cabinet with glass shelves.
This idea has its roots in the purpose to look to everyday objects in a different way. A light cabinet that is a metaphor for the household.

Dimensions:
L 70x W 45 x H 220 cm

Materials:
oak wood / grey oak wood / walnut wood;
red or natural lacquered backcloth;
crystal internal shelves;
Base: lacquered metal



4x4Wood

design: Michele Barberio - XYZ FACTORY

MOBILE CONTENITORE

Mobile contenitore con due ante ribaltabili e removibili ed un'anta verticale. Le ante removibili possono creare sedici diverse combinazioni, modificando l'aspetto del mobile a seconda dei propri gusti ed esigenze. La base è in legno massello.

Dimensioni:
L 150 x P 50 x H 150 cm

Materiali:
Legno massello e tranciato di noce canaletto / rovere;
Ante: laccate grigio / blu (altri colori a richiesta)



CUPBOARD

Storage unit with two folding and removable doors and one vertical door. The removable doors can create sixteen different combinations, modifying the appearance of the furniture according to your tastes and needs. The base is in solid wood.

Dimensions:
L 150 x W 50 x H 150 cm

Materials:
Solid walnut and veneer wood / Solid oak and veneer wood;
Doors: Gray / blue varnished lacquer
(other colours on request)



ASTEROID

design: Dmitry Kozinenko

LIBRERIA

Libreria composta da struttura e ripiani in legno, con basamento realizzato da un piede in legno e da un volume che funge da portavaso o piedistallo in legno trattato. Una libreria idealmente attraversata da un corpo estraneo caduto dall'alto che, prima di impattare con il suolo, ha creato nei ripiani dei fori che ne ricalcano la forma. Lo spazio ricavato consente di inserirvi una pianta da vaso o una scultura, da far convivere con libri e altri oggetti.

Dimensioni:
L 100 x P 40 x H 190 cm

Materiali:
Legno di noce canaletto / rovere;
Portavaso in legno trattato



BOOKCASE

Bookcase composed of wooden structure and shelves, with a base made of a wooden foot and a volume that acts as a vase holder or pedestal in treated wood. An unrelated object falls from the top and undergoes the library creating holes in the shelves before crushing on the floor. This idealistic movement produces a field where you can insert in the library a pot plant or a sculpture that can live with books or other items.

Dimensions:
L 100 x W 40 x H 190

Materials:
Walnut wood / Oak wood;
Treated wood vase holder



HIVE

design: Berno - Giacomassi - Ferrari

LIBRERIA

Modulo libreria componibile a forma esagonale, avente tre diverse profondità, con struttura in legno massello e ferro verniciato.

Dimensioni:
L 55 x P 22/30/38 x H 43 cm

Materiali:
Legno massello di noce canaletto / rovere / rovere nero / cedro;
Struttura in ferro laccata nero



BOOKCASE

Modular bookcase module in hexagonal shape, with three different depths, with structure in solid wood and lacquered iron.

Dimensions:
L 55 x W 22/30/38 x H 43

Materials:
Solid canaletto walnut wood / oak / black oak / cedar;
Black lacquered metal structure



DURAME[®]

TAVOLI

TABLES

DIAMANTE

design: C.R.S. DURAME

TAVOLO

Tavolo tondo, con piano in marmo e struttura gambe in legno.

Dimensioni:

diam. 160 x H 74 cm

diam. 180 x H 74 cm

diam. 200 x H 74 cm

diam. 220 x H 74 cm

diam. 250 x H 74 cm

lazy susan: diam. 80/100/120

Materiali:

Struttura: legno massello e tranciato di noce candiello / rovere / rovere nero;

Piano: marmo



TABLE

Round table, with marble top and wooden legs structure.

Dimensions:

diam. 160 x H 74 cm

diam. 180 x H 74 cm

diam. 200 x H 74 cm

diam. 220 x H 74 cm

diam. 250 x H 74 cm

lazy susan: diam. 80/100/120

Materials:

Structure: solid wood walnut veneer / solid wood oak veneer / solid wood black oak;

Top: marble







VUOTO

design: Dmitry Kozinenko

TAVOLO

Tavolo con piano in marmo e basi in legno massello.

Il tavolo Vuoto è una combinazione di materiali e spazio che crea una sofisticata struttura tridimensionale.

La base asimmetrica in legno massello, ha un aspetto diverso se la si guarda da prospettive distinte.

Il tavolo può avere diverse funzioni a seconda dell'utilizzo di una o due basi, dando la possibilità di avere piani di diverse forme e dimensioni.

Preziose essenze di legno sono abbinata a marmo e vetro per rendere Vuoto ancora più sofisticato.

Dimensioni:

diam. L 120/150 x H 73,5 cm (base singola)

L 180/220/250 x P 95/100 x H 73,5 cm

(base doppia)

L 300/350 x P 105 x H 73,5 cm

(base tripla)

L 400 x P 110 x H 73,5 cm

(base quadrupla)

Materiali:

Base: legno massello di noce canaletto / rovere / rovere nero;

Piano: marmo / cristallo



TABLE

Table with marble top and solid wood bases. Vuoto table is a combination of material and space that creates a sophisticated tridimensional structure.

The asymmetric base in solid wood looks different from different viewing angles.

The table can have different developments depending on the use of one or two bases, giving the possibility to have tops of different shapes and sizes.

Precious wood essences are combined with marble and glass in order to make Vuoto even more valuable.

Dimensions:

L 120/150 x H 73,5 cm (single base)

L 180/220/250 x W 95/100 x H 73,5 cm

(multiple base)

L 300/350 x W 105 x H 73,5 cm

(triple base)

L 400 x W 110 x H 73,5 cm

(quadruple base)

Materials:

Base: solid walnut wood / solid oak wood / solid black oak wood;

Top: marble / crystal







RENAISSANCE

design: Dmitry Kozinenko

TAVOLO

Tavolo in legno, con struttura in legno massello e piano impiallacciato.
Un tavolo ispirato alle architetture delle città storiche europee; nelle sue linee leggere si può riconoscere una reinterpretazione della sagoma dell'arco a tutto sesto, tipico degli edifici e delle cattedrali del Rinascimento.

Dimensioni:

L 200 x P 95 x H 74 cm
L 220 x P 95 x H 74 cm
L 240 x P 95 x H 74 cm
L 260 x P 95 x H 74 cm
L 280 x P 95 x H 74 cm
L 300 x P 95 x H 74 cm

Materiali:

Struttura in massello di noce canaletto e piano in noce canaletto;
Struttura in massello di rovere e piano in rovere;
Struttura in massello di rovere nero e piano in rovere nero

TABLE

Wooden table, with solid wood structure and veneered top.
A table inspired by historical european architecture; looking at this faint lines, one can recognize a reinterpretation of the shape of a full-centre arch, which characterizes buildings and cathedrals of the Renaissance.

Dimensions:

L 200 x W 95 x H 74 cm
L 220 x W 95 x H 74 cm
L 240 x W 95 x H 74 cm
L 260 x W 95 x H 74 cm
L 280 x W 95 x H 74 cm
L 300 x W 95 x H 74 cm

Materials:

Solid walnut wood structure and walnut wood top;
Solid oak wood structure and oak wood top;
Solid black oak wood structure and black oak wood top







DRY

design: Uto Balmoral

TAVOLO

Tavolo avente piano intarsiato in varie essenze di legno e quattro gambe impiallacciate con diverse essenze. Il tavolo ha una finitura lucida trasparente.

Dimensioni:
L 150 x P 150 x H 73,5 cm

Materiali:
Piano intarsiato: tranciato noce canaletto / palissandro / erable tinto grigio / tranciato nero / rovere;
Gambe: come struttura piano



TABLE

Table with top inlaid with various wood essences and four legs veneered with different essences. The table has a transparent glossy finish.

Dimensions:
L 150 x W 150 x H 73,5 cm

Materials:
Inlaid top: walnut veneer / rosewood veneer / grey stained erable veneer / black veneer / oak veneer;
Legs: as a top structure



GAB

design: C.R.S. DURAME

TAVOLO

Tavolo con piano in legno o marmo e struttura con gambe in legno massello.

Dimensioni:

L 180 x P 95 x H 73,5 cm
L 200 x P 100 x H 73,5 cm
L 220 x P 100 x H 73,5 cm
L 240 x P 100 x H 73,5 cm
L 260 x P 100 x H 73,5 cm

Materiali:

Struttura: massello di noce canaletto / rovere / rovere nero;
Piano: legno di noce canaletto / rovere / rovere nero / marmo



TABLE

Table with wooden or marble top and structure with solid wood legs.

Dimensions:

L 180 x W 95 x H 73,5 cm
L 200 x W 100 x H 73,5 cm
L 220 x W 100 x H 73,5 cm
L 240 x W 100 x H 73,5 cm
L 260 x W 100 x H 73,5 cm

Materials:

Structure: solid walnut wood / solid oak wood / solid black oak wood;
Top: walnut wood / oak wood / black oak wood / marble



DON

design: C.R.S. DURAME

TAVOLO

Tavolo in legno di varie dimensioni, avente struttura in legno massello e il piano impiallacciato.

Dimensioni:

L 180 x P 95 x H 74 cm
L 200 x P 95 x H 74 cm
L 220 x P 95 x H 74 cm
L 240 x P 95 x H 74 cm
L 260 x P 95 x H 74 cm

Materiali:

Struttura in massello di noce canaletto e piano in noce canaletto;
Struttura in massello di rovere e piano in rovere



TABLE

Wooden table of various sizes, with solid wood structure and veneered top.

Dimensions:

180 x W 95 x H 74 cm
200 x W 95 x H 74 cm
220 x W 95 x H 74 cm
240 x W 95 x H 74 cm
260 x W 95 x H 74 cm

Materials:

Solid walnut wood structure and walnut wood top;
Solid oak wood structure and oak wood top.



TA.ta wood

design: Michele Barberio - XYZ FACTORY

TAVOLO

Tavolo in legno di varie dimensioni, avente struttura in legno massello e piano impiallacciato, con eventuale tasca portaoggetti sul piano.

Dimensioni:

L 200 x P 80 x H 74 cm
L 220 x P 80 x H 74 cm
L 240 x P 80 x H 74 cm
L 260 x P 80 x H 74 cm

Materiali:

Struttura in massello di noce canaletto e piano in noce canaletto;
Struttura in massello di rovere e piano in rovere;
Struttura in massello di rovere nero e piano in rovere nero



TABLE

Wooden table of various sizes, with solid wood structure and veneered top, with possible storage pocket on the top.

Dimensions:

L 200 x W 80 x H 74 cm
L 220 x W 80 x H 74 cm
L 240 x W 80 x H 74 cm
L 260 x W 80 x H 74 cm

Materials:

Solid walnut wood structure and walnut wood top;
Solid oak wood structure and oak wood top;
Solid black oak wood structure and black oak wood top



ICS

design: C.R.S. DURAME

TAVOLO

Tavolo con top composto da tavole di legno massello e struttura in ferro cerato.

Dimensioni:

L 180 x P 80 x H 74 cm
L 200 x P 80 x H 74 cm
L 220 x P 80 x H 74 cm
L 240 x P 80 x H 74 cm

Materiali:

Piano: legno massello di rovere / castagno /
noce canaletto;
Struttura: ferro cerato

TABLE

Table with top made of solid
wood boards and waxed iron
structure.

Dimensions:

L 180 x W 80 x H 74 cm
L 200 x W 80 x H 74 cm
L 220 x W 80 x H 74 cm
L 240 x W 80 x H 74 cm

Materials:

Top: solid oak wood / chestnut /
walnut;
Waxed metal structure

TUB

design: C.R.S. DURAME

TAVOLO

Tavolo composto da top con tavole di legno massello e struttura tubolare in ferro cerato.

Dimensioni:

L 180 x P 80 x H 74 cm
L 200 x P 80 x H 74 cm
L 220 x P 80 x H 74 cm
L 240 x P 80 x H 74 cm

Materiali:

Piano: legno massello di rovere / castagno /
noce canaletto;
Struttura: ferro cerato



TABLE

Table composed of a top with solid wood boards and a tubular structure in waxed iron.

Dimensions:

L 180 x W 80 x H 74 cm
L 200 x W 80 x H 74 cm
L 220 x W 80 x H 74 cm
L 240 x W 80 x H 74 cm

Materials:

Top: solid oak wood / chestnut /
walnut;
Waxed metal structure



DURAME®

TAVOLINI

LOW TABLES

TEA

design: Sara Ferrari

TAVOLINO CONTENITORE

Tavolino con base in vetro in due diverse altezze e top in legno massello avente forma a tappo o vassoio, in varie essenze.

Contenitore composto da un grande vaso in vetro colorato in cui riporre oggetti, riviste o altri beni personali e da un "tappo" in legno che funge da piano d'appoggio, utilizzabile anche come vassoio.

Dimensioni:
diam. 40 x H 35,5 cm (Basso);
diam. 40 x H 41,5 cm (Alto)

Materiali:
Vaso in vetro, colori: fumé / ambra;
Top: in legno massello di rovere /
rovere nero / rovere grigio / noce canaletto /
laccato lucido

Maniglia in cuoio (Top piccolo)



CONTAINER SIDE TABLE

Coffee table with glass base in two different heights and solid wood top in the shape of a cap or tray, in various essences.
Container table made up of a big colorful glass vase in which you can place objects, newspapers or other personal items and a wooden cap that works as a table top and can be useful as a tray.

Dimensioni:
diam. 40 x H 35,5 cm (Low);
diam. 40 x H 41,5 cm (High)

Materials:
Glass vase colors: smoked / amber;
Top: solid oak wood / solid black oak wood / solid
grey oak wood / solid canaletto walnut wood /
glossy lacquered wood

Leather handle (Small top)





JEAN ORDINARY

design: Uto Balmoral

TAVOLINO

Tavolino con piano in legno impiallacciato ad intarsio e gambe in metallo in diverse finiture.

Dimensioni:
diam. 60 x H 28 cm (Tre gambe);
diam. 60 x H 38 cm (Tre gambe);
L 160 x P 70 x H 28 cm (Quattro gambe);
L 160 x P 70 x H 38 cm (Quattro gambe)

Materiali:
Piano: legno massello e tranciato di noce canaletto / rovere / rovere nero / frassino laccato nero / laccato lucido (colori ral a richiesta);
Gambe: laccato ottone / canna di fucile / bronzo



SIDE TABLE

Coffee table with inlay veneered wood top and metal legs in different finishes.

Dimensioni:
diam. 60 x H 28 cm (Three legs);
diam. 60 x H 38 cm (Three legs);
L 160 x W 70 x H 28 cm (Four legs);
L 160 x W 70 x H 38 cm (Four legs)

Materiali:
Top: solid wood and walnut veneer / solid wood and oak veneer / solid wood and black oak veneer / solid black ash wood / lacquered (ral colors on request);
Legs: lacquered brass / lacquered gunmetal / lacquered bronze





114



115



JEAN

design: Uto Balmoral

TAVOLINO

Tavolino con piano laccato lucido e gambe in metallo in diverse finiture.

Tavolini asimmetrici e sovrapponibili, dove dinamismi e linee spezzate ammorbidite da leggeri raggi di curvatura danno la possibilità a questi pezzi di adattarsi alle più svariate situazioni domestiche e non, generando vibrazioni e piacevoli spiazzamenti.

Caratterizzato da piani colorati laccati lucido e gambe in ottone o in ferro, Jean risulta essere un oggetto dove forme, materiali e colori diversi convivono insieme.

Dimensioni:

L 57 x P 72 x H 28 cm (Piccolo);

L 57 x P 72 x H 38 cm (Piccolo);

L 160 x P 91 x H 28 cm (Grande);

L 160 x P 91 x H 38 cm (Grande)

Materiali:

Piano: laccato blu / bordeaux / rosa
(altri colori a richiesta);

Gambe: laccato ottone / canna di fucile /
bronzo

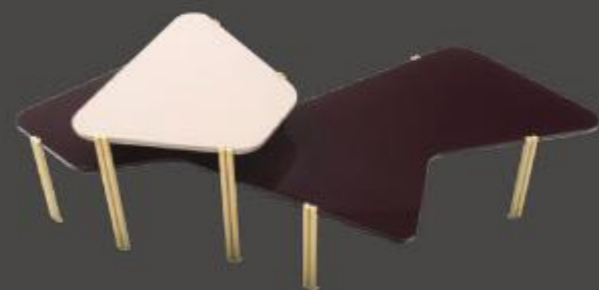

SIDE TABLE

Coffee table with glossy lacquered top and metal legs in different finishes.

Side tables dynamisms and broken lines softened by slight bending radii give the possibility to these pieces to adapt to the most varied domestic and non-domestic situations.

Jean is an object where different shapes, materials and colors coexist together. It's characterized by colored lacquered or wooden tops and legs made of brass or iron.

Dimensioni:

L 57 x W 72 x H 28 cm (Small);

L 57 x W 72 x H 38 cm (Small);

L 160 x W 91 x H 28 cm (Big);

L 160 x W 91 x H 38 cm (Big)

Materiali:

Top: lacquered blue / bordeaux / pink
(other colors on request);

Legs: lacquered brass / lacquered gunmetal /
lacquered bronze





MOON

design: C.R.S. DURAME

TAVOLINO

Tavolino con piano in marmo e struttura composta da quattro gambe in legno massello.

Dimensioni:
diam. 85 x H 31 cm
diam. 50 x H 41 cm

Materiali:
Struttura: legno massello e tranciato di noce
canaletto / rovere / rovere nero;
Piano: marmo



SIDE TABLE

Coffee table with marble top and structure made up of four solid wood legs.

Dimensioni:
diam. 85 x H 31 cm
diam. 50 x H 41

Materials:
Structure: solid canaletto walnut wood /
solid oak wood / solid black oak wood;
Top: marble



JOKER

design: C.R.S. DURAME

TAVOLINO

Tavolino con struttura e gambe in legno massello, caratterizzato dal top composto da un volume contenitore chiuso da un piano rivestito in pelle.

Dimensioni:
diam. 53 x H 53

Materiali:
Struttura: legno massello e tranciato di noce canaletto / rovere / rovere nero;
Piano: legno e pelle



SIDE TABLE

Coffee table with structure and legs in solid wood, characterized by the top consisting of a container volume closed by a top covered in leather.

Dimensions:
diam. 53 x H 53

Materials:
Structure: solid canaletto walnut wood / solid oak wood / solid black oak wood;
Top: wood and leather



BMIO

design: C.R.S. DURAME

TAVOLINO

Tavolino con piano circolare impiattacciato ad intarsio e struttura con gambe in legno massello.

Dimensioni:
diam. 50 x H 55

Materiali:
Struttura: legno massello e tranciato di noce canaletto / rovere / rovere nero;
Piano: legno intarsiato



SIDE TABLE

Coffee table with circular inlay veneered top and structure with solid wood legs.

Dimensions:
diam. 50 x H 55

Materials:
Structure: solid canaletto walnut wood / solid oak wood / solid black oak wood;
Top: inlaid wood



DRY side table

design: Uto Balmoral

TAVOLINO

Tavolino con piano intarsiato in varie essenze di legno e quattro gambe impiattate con diverse essenze. Il tavolo ha una finitura lucida trasparente.

Dimensioni:

L 100 x P 50 x H 40 cm
L 120 x P 60 x H 40 cm
L 140 x P 70 x H 40 cm
L 160 x P 80 x H 40 cm

Materiali:

Piano intarsiato: tranciato noce canaletto / palissandro / erable tinto grigio / tranciato nero / rovere / acero;
Gambe: come struttura piano



SIDE TABLE

SideTable with top inlaid with various wood essences and four legs veneered with different essences. The table has a transparent glossy finish.

Dimensions:

L 100 x W 50 x H 40 cm
L 120 x W 60 x H 40 cm
L 140 x W 70 x H 40 cm
L 160 x W 80 x H 40 cm

Materials:

Inlaid top: walnut veneer / rosewood veneer / grey stained erable veneer / black veneer / oak veneer / maple;
Legs: as a top structure



NAZCA

design: Elena Salmistraro

TAVOLINO

Tavolino con piano impiallacciato in essenza con incisioni e gambe tornite in legno massello. Un coffee-table dal forte contenuto simbolico, con un piano in legno dalla forma asimmetrica e armoniosa, priva di spigoli, impreziosita da disegni geometrici incisi che traggono ispirazione dai geoglifi del Deserto di Nazca.

Dimensioni:
L 130 x P 97 x H 35 cm

Materiali:
Legno massello e tranciato di rovere /
legno massello e tranciato di noce canaletto



SIDE TABLE

Coffee table with wood veneer top with engravings and turned solid wood legs. A coffee-table with a high symbolic content. Its surface is characterized by a an harmonious and asymmetric shape, without sharp edges. It is also adorned by carved geometrical motifs, inspired by the geoglyphs of the Nazca Desert.

Dimensioni:
L 130 x W 97 x H 35 cm

Materiali:
Solid oak and veneer wood / solid canaletto
walnut and veneer wood



KURTZ

design: Vernicemogano

TAVOLINO

Tavolino formato da struttura in metallo verniciato, con piano in cristallo e da una sezione di tronco di cedro. Una forma geometrica lineare di metallo e vetro cattura una sezione di tronco di legno e si fonde con essa per spartirsi identità e funzionalità.

Dimensioni:
L 140/145 ca. x P 65/70 ca. x H 37 cm

Materiali:
Legno massello di cedro sabbato;
Struttura in ferro laccata nero;
Piano in vetro

SIDE TABLE

Side table formed by a painted metal structure, with a glass top and a cedar trunk section. A linear geometrical shape made of metal and glass catches a log wood section and blends with it to share their identities and functionalities.

Dimensions:
L 140/145 ca. x W 65/70 ca. x H 37 cm

Materials:
Sandblasted solid cedar wood;
Black lacquered metal;
Glass top



MARLOW

design: Vernicemogano

TAVOLINO

Tavolino formato da struttura in metallo verniciato, con piano in cristallo e da una sezione di tronco di cedro laccata nera. Ad una essenziale struttura di metallo e vetro formalmente incompleta viene in soccorso una sezione di tronco di legno che, innestandosi su di essa, si inventa supporto dalla forte valenza organica.

Dimensioni:
L 60 x P 50 x H 60 ca. cm (piano H 50 cm)

Materiali:
Legno massello di cedro sabbiato laccato nero;
Struttura in ferro laccato nero;
Piano in vetro

SIDE TABLE

Side table made up of a painted metal structure, with a glass top and a black lacquered cedar trunk section. A section of a wood log gives aid to a formally unended structure made by metal and glass, creating a valuable organic frame.

Dimensioni:
L 60 x W 50 x H 60 ca. cm (top H 50 cm)

Materials:
Sandblasted black lacquered solid cedar wood;
Black lacquered metal;
Glass top



TOC

design: C.R.S. DURAME

TAVOLINO

Tavolino con piano formato da sezione trasversale di un tronco di cedro e gambe in ferro cerato.

Dimensioni:
diam. tra 50 cm e 60 cm ca. / H 26 cm
(Tre gambe);
diam. tra 65 cm e 80 cm ca. / H 26 cm
(Tre gambe / Quattro gambe)

Materiali:
Legno massello di cedro sabbiato;
Gambe in ferro cerato



SIDE TABLE

Tavolino con piano formato da sezione trasversale di un tronco di cedro e gambe in ferro cerato.

Dimensioni:
diam. 50/60 cm ca. / H 26 cm
(Three legs);
diam. 65/80 cm ca. / H 26 cm
(Three legs / Four legs)

Materiali:
Sandblasted solid cedar wood;
Legs waxed metal



InsTABLE

design: Michele Borberio – XYZ FACTORY

TAVOLINO

Tavolino avente il piano realizzato dall'unione di tre sezioni di tronco di cedro, sorretto da tre gambe in ferro verniciato con puntalino in legno massello.

Dimensioni:
L 90 ca. x P 70 ca. x H 35 cm

Materiali:
Legno massello di cedro sabbiato;
Struttura in ferro laccato nero con piedi in legno massello



COFFEE TABLE

Coffee table having the top made from the union of three sections of cedar trunk supported by three legs in painted iron with a solid wood tip.

Dimensions:
L 90 ca. x W 70 ca. x H 35 cm

Materials:
Sandblasted solid cedar wood;
Black lacquered metal legs with solid wood feet



DURAME®

SCRIVANIE-CONSOLLE

DESK-CONSOLLE

BUTTER TOILETTA

design: Dmitry Kozinenko

MOBILE TOILETTA

Mobile Toilettta con struttura in legno con cassetto. Il piano è caratterizzato da uno specchio orientabile e da un vassoio portaoggetti in legno massello.

Dimensioni:
L 140 x P 65 x H 73,5 cm
L 140 x P 50 x H 73,5 cm

Materiali:
Struttura: legno massello e tranciato di noce canaletto / rovere / rovere nero;
Tubolare in ferro: verniciato canna di fucile / ottone / bronzo;
Specchio



DRESSING TABLE

Dressing table with wooden structure with drawer. The top is characterized by an adjustable mirror and a solid wood storage tray.

Dimensions:
L 140 x W 65 x H 73,5 cm
L 140 x W 50 x H 73,5 cm

Materials:
Structure: solid canaletto walnut wood veneer / solid oak wood veneer / solid black oak wood veneer;
Iron tubular: lacquered gunmetal / lacquered brass / lacquered bronze;
Mirror

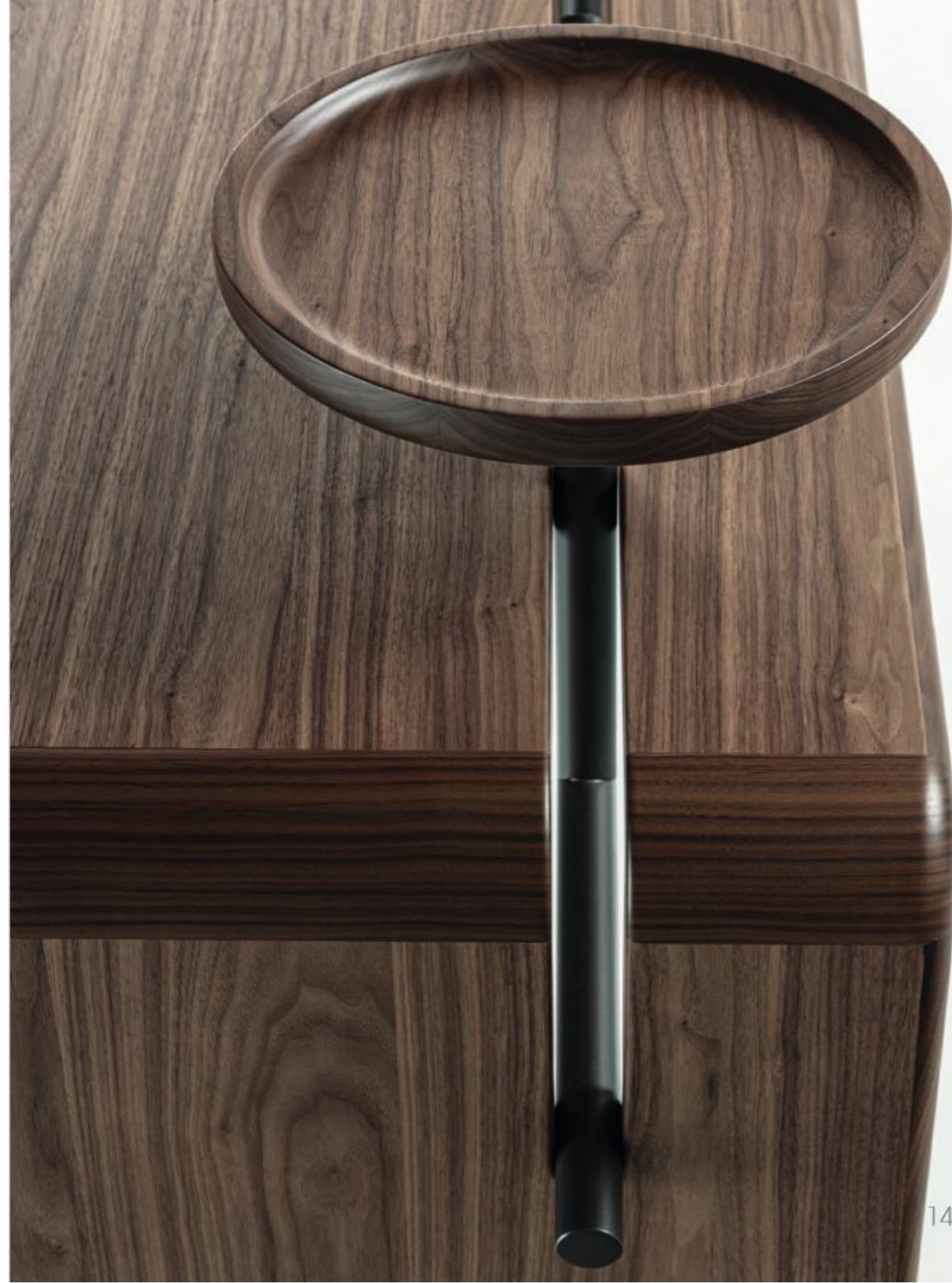



DURAME[®]

SEDUTE

SEATINGS

HERMITAGE

design: C.R.S. DURAME



DIVANO

Divano con base in legno massello e struttura imbottita con la possibilità di avere braccioli imbottiti oppure in legno e paglia di vienna.

Dimensioni:

L 110 x P 100 x H 80 cm
L 210 x P 100 x H 80 cm
L 230 x P 100 x H 80 cm
L 250 x P 100 x H 80 cm
L 280 x P 100 x H 80 cm

Materiali:

Legno massello di noce canaletto / rovere / rovere nero;
Seduta: pelle o tessuto

SOFA

Sofa with solid wood base and padded structure with the possibility of having padded armrests or in wood and Vienna straw.

Dimensions:

L 110 x W 100 x H 80 cm
L 210 x W 100 x H 80 cm
L 230 x W 100 x H 80 cm
L 250 x W 100 x H 80 cm
L 280 x W 100 x H 80 cm

Materials:

solid canaletto walnut wood / solid oak wood / solid black oak wood;
Seat: leather or fabric







GAZZELLA

design: Maurizio Di Lauro

POLTRONA

Poltrona con struttura in legno massello e rivestimento con pelle.

Dimensioni:
L 86,5 x P 63,5 x H 82,5 cm

Materiali:
Struttura: legno massello di noce canaletto / rovere / rovere nero / frassino laccato nero;
Seduta: imbottita in pelle



ARMCHAIR

Armchair with solid wood frame and leather.

Dimensions:
L 86,5 x W 63,5 x H 82,5 cm

Materials:
Structure: solid walnut wood / solid oak wood / solid black oak wood / black lacquered solid ash wood;
Seat: leather padding







MILLEMIGLIA SUPER

design: Andrea Gerosa

SEDIA

Poltrona con struttura in legno massello e rivestimento con pelle o tessuto. Millemiglia Super è una poltroncina bassa e confortevole, con braccioli, schienale curvato e soffice seduta imbottita.

Dimensioni:
L 70 x P 56 x H 63 cm (H seduta 38 cm)

Materiali:
Struttura: legno massello di rovere / rovere nero / noce canaletto / frassino nero;
Seduta: imbottita in tessuto / pelle

CHAIR

Armchair with solid wood frame and leather or fabric. Millemiglia Super is a low and comfortable armchair with a curved back and a soft padded seat.

Dimensions:
L 70 x W 56 x H 63 cm (H seat 38 cm)

Materials:
Structure: solid oak wood / Black solid oak wood / solid canaletto walnut wood / solid ash wood;
Seat: cloth padding / leather





MILLEMIGLIA

design: Andrea Geroso

SEDIA

Sedia con struttura in legno massello e rivestimento con pelle o tessuto. Ispirata alle affascinanti forme dei bolidi a motore del passato, Millemiglia è una seduta in legno massello con braccioli, dalle forme slanciate ed ergonomiche.

Dimensioni:
L 57 x P 50 x H 75 cm (H seduta 45 cm)

Materiali
Struttura: legno massello di rovere / rovere nero / noce canaletto / frassino nero;
Seduta: legno / imbottita in tessuto o pelle

CHAIR

Chair with solid wood frame and leather or fabric.
The fascinating shapes of the old racing cars inspired Millemiglia, a thin and ergonomic chair with armrests and made of solid wood.

Dimensions:
L 57 x W 50 x H 75 cm (H seat 45 cm)

Materials:
Structure: solid oak wood / Black solid oak wood / solid canaletto walnut wood / solid ash wood;
Seat: wood / cloth padding or leather





GRETA

design: Paolo Salvadè

POLTRONCINA

Poltroncina con struttura in legno massello e rivestimento con pelle o tessuto.

Dimensioni:
L 67 x P 65 x H 83 cm
L 57,5 x P 60 x H 83 cm

Materiali
Struttura: legno massello di noce canaletto / frassino / frassino nero;
Seduta: imbottita in tessuto o pelle



ARMCHAIR

Armchair with solid wood frame and leather or fabric.

Dimensions:
L 67 x W 65 x H 83 cm
L 57,5 x W 60 x H 83 cm

Materials:
Structure: solid canaletto walnut wood / solid ash wood / solid black ash wood;
Seat: cloth padding or leather







CROSS

Archivio Storico Molteni/Durame
+ Uto Balmoral

SEDIA

Poltrona con struttura in legno massello e seduta in cinghie colorate.
Dall'Archivio Storico Durame, ecco una famiglia di sedute dove leggerezza e versatilità caratterizzano una struttura in legno massello e tessuto tecnico.

Dimensioni:
L 40 x P 40 x H 77 (H seduta 44 cm)

Materiali:
Struttura in legno massello di rovere / rovere nero / noce canaletto / frassino nero;
Seduta in cinghie di tessuto tecnico intrecciate disponibili in vari colori



CHAIR

Armchair with solid wood structure and seat in colored belts.
From Durame's Historical Archive, a family of seats whose lightness and versatility characterize a structure made of solid wood and technical woven.

Dimensions:
L 40 x W 40 x H 77 (H seat 44 cm)

Materials:
Solid oak wood / black solid oak wood / solid canaletto walnut wood / solid black ash wood;
Seat made of technical woven intersected belts available in different colours

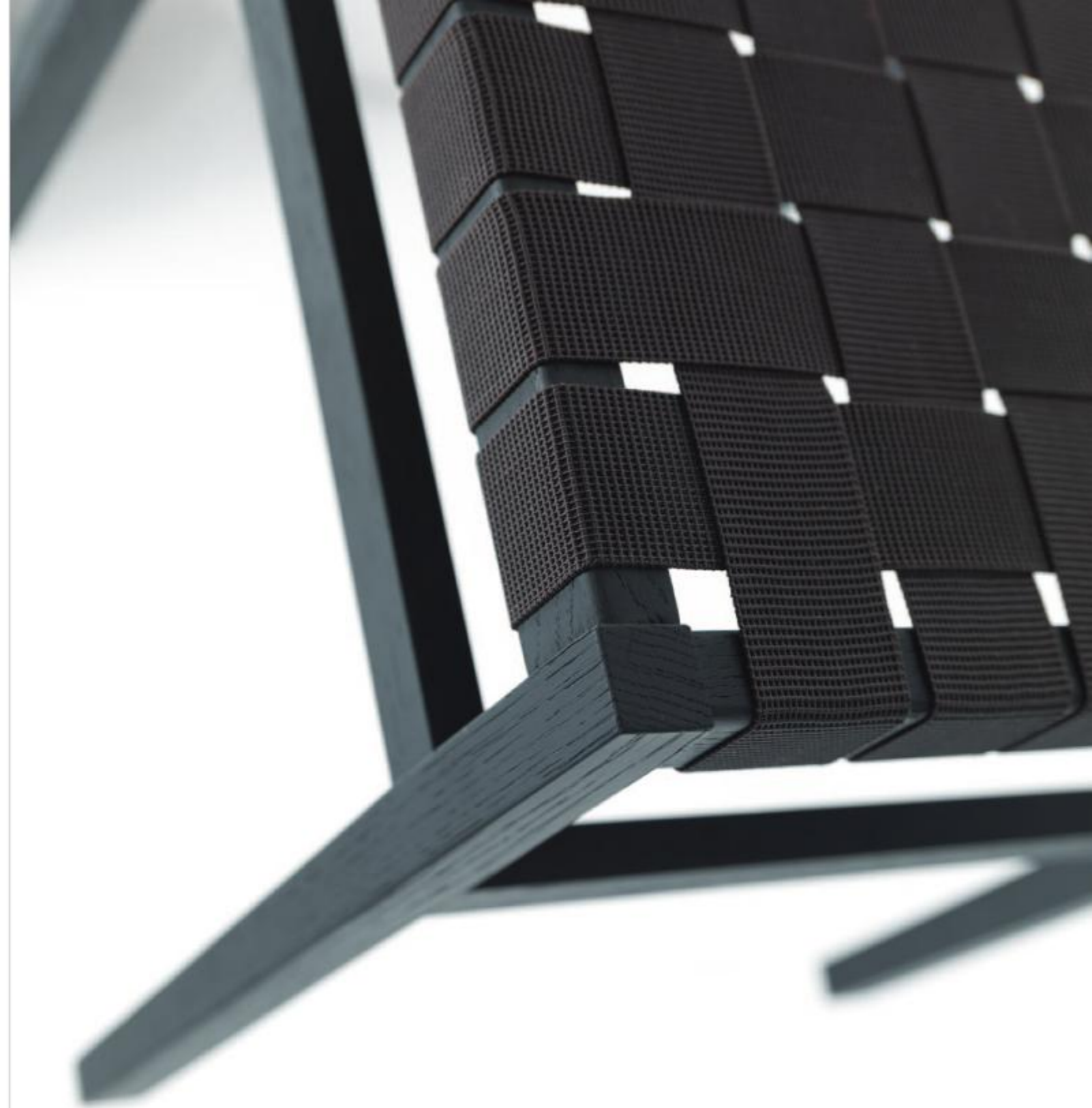



CROSS

Archivio Storico Molteni/Durame
+ Uto Balmoral



POLTRONCINA / POGGIAPIEDI

Sedia con struttura in legno massello e seduta in cinghie colorate.

Dall'Archivio Storico Durame, ecco una famiglia di sedute dove leggerezza e versatilità caratterizzano una struttura in legno massello e tessuto tecnico.

Dimensioni:

Poltroncina piccola:
L 55,5 x P 57 x H 77 (H seduta 40 cm)

Poltroncina grande:
L 65,5 x P 57 x H 77 (H seduta 40 cm)

Poggiapiedi piccolo: L 45 x P 45 x H 26

Poggiapiedi grande: L 50 x P 45 x H 26

Materiali:

Struttura in legno massello di rovere / rovere nero / noce canaletto / frassino nero;
Seduta in cinghie di tessuto tecnico intrecciate disponibili in vari colori

ARMCHAIR / FOOTREST

Chair with solid wood structure and seat in colored belts.

From Durame's Historical Archive, a family of seats whose lightness and versatility characterize a structure made of solid wood and technical woven.

Dimensioni:

Small armchair:
L 55,5 x W 57 x H 77 (H seat 40 cm)

Large armchair:
L 65,5 x W 57 x H 77 (H seat 40 cm)

Small footrest: L 45 x W 45 x H 26

Large footrest: L 50 x W 45 x H 26

Materials:

Solid oak wood / black solid oak wood / solid canaletto walnut wood / solid black ash wood;
Seat made of technical woven intersected belts available in different colours



EXPERIMENTA

design: Un Pizzo with Carlo Marelli

POLTRONA

Poltrona con struttura in legno massello con schienale in pizzo realizzato con corda. Una poltrona nata da una ricerca che unisce due arti tipiche Brianzole: la lavorazione artigianale del legno e quella del pizzo al tombolo.

Dimensioni:
L 120 x P 83 x H 82 cm
(H seduta 40 cm)

Materiali:
Struttura in legno massello di rovere / noce
canaletto;
Seduta: tessuto;
Schienale poltrona: intreccio di corda in cotone

ARMCHAIR

Armchair with solid wood structure with lace back made with rope. An armchair derived from a research that unifies two traditional arts from Brianza: wooden handcraft and bobbin lace.

Dimensions:
L 120 x P 83 x H 82 cm
(H seat 40 cm)

Materials:
Solid oak wood structure / solid canaletto
walnut structure;
Seat: fabric;
Armchair backrest: woven with cotton rope







BUTTER BENCH

design: Dmitry Kozinenko

PANCHINA

Panchina completamente rivestita in pelle o tessuto caratterizzata da tubolare in metallo verniciato e vassoio portaoggetti in legno massello.

Dimensioni:
L 130 x P 51 x H 45 cm
L 150 x P 51 x H 45 cm
L 170 x P 51 x H 45 cm

Materiali:
Imbottito di pelle o tessuto;
Vassoio portaoggetti: legno massello di noce canaletto / rovere / rovere nero;
Tubolare: verniciato nero / verniciato bronzo

BENCH

Bench completely covered in leather or fabric characterized by painted metal tubular and solid wood storage tray.

Dimensions:
L 130 x W 51 x H 45 cm
L 150 x W 51 x H 45 cm
L 170 x W 51 x H 45 cm

Materials:
Padded with leather or fabric;
Storage tray: solid canaletto walnut wood / solid oak wood / solid black oak wood;
Tubular: lacquered black / lacquered bronze



JEAN DAYBED

design: Uto Balmoral

DAYBED

Daybed con piano in legno e quattro gambe in metallo verniciato, con materassino imbottito rivestito in pelle o tessuto.

Dimensioni:
L 200 x P 70 x H 38 cm

Materiali:
Materiali:
Legno massello di noce canaletto / rovere / rovere nero;
Seduta: pelle o tessuto;
Gambe: Gambe: laccato ottone / canna di fucile / bronzo



DAYBED

Daybed with wooden top and four legs in painted metal, with padded mattress covered in leather or fabric.

Dimensions:
L 200 x W 70 x H 38 cm

Materials:
solid canaletto walnut wood / solid oak wood / solid black oak wood;
Seat: leather or fabric;
Legs: lacquered brass / lacquered gunmetal / lacquered bronze





b2b

design: Vernicemogano

PANCA/PORTARIVISTE-LIBRI

Panchina in legno massello con base in metallo verniciato, con vani portariviste-libri.

Dimensioni:
L 175 x P 28 x H 38 cm
L 220 x P 28 x H 38 cm

Materiali:
Legno massello di rovere;
Ferro laccato nero



BENCH/MAGAZINE-BOOK RACK

Bench in solid wood with lacquered metal base, with magazine-book compartments.

Dimensions:
L 175x W 28x H 38 cm
L 220 x W 28x H 38 cm

Materials:
Solid oak wood;
Black lacquered metal



DEAR

design: C.R.S. DURAME

POUFF

Pouff imbottito e rivestito in pelle.

Dimensioni:
L 46 x P 46 x H 46 cm

Materiali:
imbottitura in pelle



POUFF

Pouff padded and covered in leather.

*Dimensions:
L 46x W 46 x H 46 cm*

*Materials:
Leather padding*

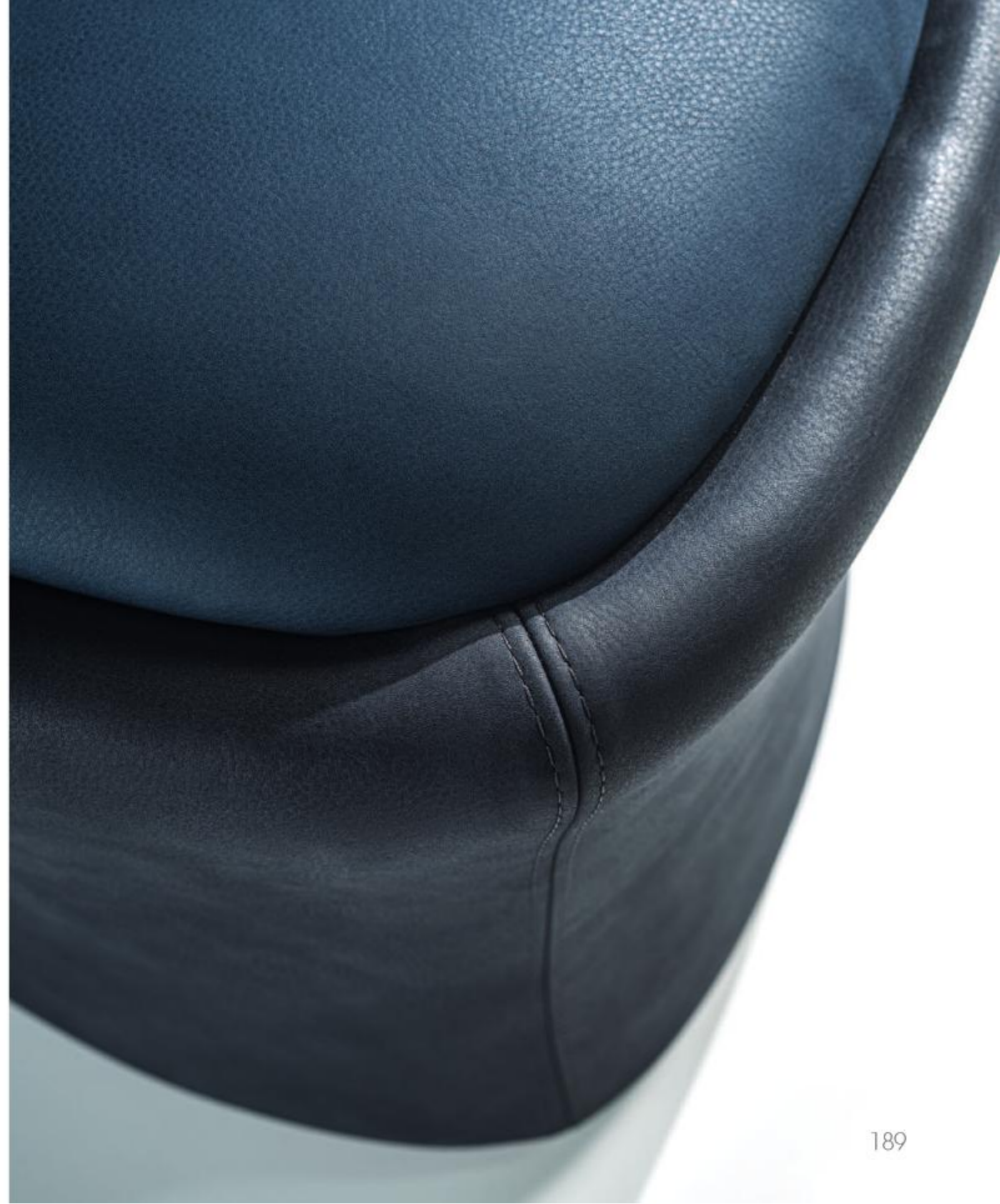

GRAFT

design: Damien Gernoy

SEDIA

Seduta in legno massello di cedro, con schienale in tubolare di ferro verniciato nero. Un semplice tronco di legno tagliato può essere usato come seduta; l'innesto di uno schienale ne aumenta la funzionalità, ne arricchisce l'estetica e lo trasforma in un vero e proprio oggetto d'arredo.

Dimensioni:
L 55 x P 45 x H 75 cm
(H seduta 45 cm)

Materiali:
Legno massello di cedro;
Ferro laccato nero



CHAIR

Seat in solid cedar wood, with black lacquered iron tubular back. A simple log can be cut and used as a seat; the insertion of a seatback increases its functionality and enriches its aesthetics. The final result is a real piece of furniture.

*Dimensions:
L 55 x W 45 x H 75 cm
(H seat 45 cm)*

*Materials:
Solid cedar wood;
Black lacquered metal*





SEMUC

design: Maurizio Di Lauro

SGABELLO

Seduta in legno massello di cedro.
Semuc è un luogo incantato che ha ispirato uno sgabello che si può utilizzare in modo tradizionale oppure tramutare in una ludica seduta a dondolo.
E' adatto sia per spazi interni che esterni.

Dimensioni:
diam. 30 x H 30 cm (Piccolo);
diam. 44 x H 41 cm (Grande)

Materiali:
Legno massello di cedro



STOOL

Seat in solid cedar wood.
Semuc is an enchanted place that inspired a stool which can be used in the traditional way, but it may even become a recreational rocking chair. Suitable for both outdoor and indoor areas.

Dimensions:
diam. 30 x H 30 cm (Small);
diam. 44 x H 41 cm (Large)

Materials:
Solid cedar wood



DURAME[®]

LETTI

BEDS

BRIDGE Bed

design: Paolo Salvadè - C.R.S. DURAME

LETTO

Letto con testata in legno massello e pelle, dove i dettagli impreziosiscono le forme, fornendo eleganza e particolarità.

Dimensioni:
testata: 230 x 105 cm
testata con ali: 358 x 105 cm
letto: 188 x 208 cm.

Materiali:
legno massello e tranciato di noce canaletto / rovere / rovere nero;
imbottitura in pelle o tessuto



BED

Bed with headboard in solid wood and leather, where details embellish the shapes, providing elegance and particularity.

Dimensions:
headboard: 230 x 105 cm
headboard with wings: 358 x 105 cm
bed: 188x208 cm.

Materials:
solid wood and walnut veneer / solid wood and oak veneer / solid wood and black oak veneer;
Upholstery in leather or fabric





DURAME[®]

COMPLEMENTI

COMPLEMENTS

IRPIN

design: Dmitry Kozinenko

SPECCHIERA

Specchiera circolare di vari diametri, sostenuta da una struttura in legno con vassoio portaoggetti.

Dimensioni:
diam. 72 x H 230 cm
diam. 90 x H 230 cm

Materiali:
Struttura: legno massello di noce canaletto / rovere / rovere nero;
Specchio



MIRROR

Circular mirror of various diameters, supported by a wooden structure with storage tray.

Dimensions:
diam. 72 x H 230 cm
diam. 90 x H 230 cm

Materials:
Structure: solid canaletto walnut wood / solid oak wood / solid black oak wood;
Mirror





OBLIQUE

design: Paolo Salvadè

SPECCHIO

Specchiera con cornice appendiabiti in legno massello.

Dimensioni:
Cornice in legno:
L 70 x H 120 cm
Specchio:
L 48 x H 97 cm (Piccolo)
L 48 x H 188 cm (Grande)

Materiali:
Legno massello di noce canaletto / rovere / rovere nero;
Specchio;
Appendiabiti in metallo bronzato



MIRROR

Mirror with coat hanger frame in solid wood.

Dimensions:
Wooden frame:
L 70 x H 120 cm
Mirror:
L 48 x H 97 cm (Small);
L 48 x H 188 cm (Large)

Materials:
Solid canaletto walnut wood / solid oak wood / solid black oak wood;
Mirror;
Bronzed metal coat hanger



EDES

design: Paolo Salvadè

SPECCHIO

Specchiera con cornice in legno massello. Uno specchio dalle linee semplici, con una cornice sfaccettata in legno massello, impreziosita da un'elegante asimmetria.

Dimensioni:
70 x 61 cm (Piccolo);
70 x 115 cm (Grande)

Materiali:
Legno massello di noce canaletto / rovere / rovere nero;
Specchio



MIRROR

Mirror with solid wood frame. A simple-shaped mirror with a multifaceted frame made of solid wood, and decorated with an elegant asymmetry.

Dimensions:
70 x 61 cm (Small);
70 x 115 cm (Large)

Materials:
Solid canaletto walnut wood / solid oak wood / solid black oak wood;
Mirror



ETNA

design: studio BAAG

SPECCHIERA

Specchiera con cornice in legno massello. Linee morbide in legno massello definiscono una sagoma organica e naturale. Superfici concave e convesse che si inseguono, si compenetrano fino a fondersi in un cratere in cui riflettere la propria immagine per lasciarsene catturare l'essenza.

Dimensioni:
Specchio ellittico 55x77 cm
Specchio circolare diam. 60 cm

Materiali:
Legno massello di noce canaletto / rovere / rovere nero;
Specchio



MIRROR

Mirror with solid wood frame. Soft lines in solid wood define an organic and natural silhouette. Concave and convex surfaces chase and penetrate each other until merging into a crater, in which to reflect the image of yourself and to capture your essence.

Dimensions:
Elliptical mirror 55x77 cm
Circular mirror diam. 60 cm

Materials:
Solid canaletto walnut wood / solid oak wood / solid black oak wood;
Mirror



SEED

design: Uto Balmoral

APPENDIABILI

Appendiabiti, con struttura in legno massello e metallo. La terra dà frutti solo se viene adeguatamente seminata e nutrita, l'appendiabiti si ispira all'immagine poetica dei primi germogli che appaiono ed escono dal terreno nella fase di crescita, immediatamente precedente la fioritura.

Dimensioni:
h 185 cm

Materiali:
Legno massello di rovere /
Struttura in ferro verniciata nero;
Legno massello di noce canaletto /
Struttura in ferro ottonato



COAT HANGER

Coat hanger, with solid wood and metal structure. The earth creates product only if you put seeds in it, the coat hanger is inspired by the poetic image of the sprout in the growing phase just before the blossom.

Dimensioni:
h 185 cm

Materiali:
Solid oak wood /
Black lacquered metal;
Solid canaletto walnut wood /
Brassed metal



PLANETS

design: Uto Balmoral

APPENDIABILI

Appendiabiti, con struttura in metallo e sfere in legno massello.

Dimensioni:
H 178 cm

Materiali:
Legno massello di noce canaletto / rovere;
Struttura in ferro verniciata
canna di fucile



COAT HANGER

Coat hanger, with metal structure and solid wood spheres.

Dimensioni:
H 178 cm

Materiali:
Solid walnut wood /
solid oak wood;
Gunmetal lacquered iron structure



AMO

design: Maurizio Di Lauro

GANCIO APPENDIABILI

Appendiabiti in legno massello sorretto da cavo in acciaio.

Un leggero manufatto in legno che si staglia sospeso nello spazio rivelandosi una presenza discreta dalla forte valenza evocativa.

Si compone di un sottile cavo d'acciaio e una sorta di amo a cui appendere indifferentemente abiti, cappelli, borse...

Dimensioni:

H 12,5 cm (Piccolo);

H 14 cm (Medio);

H 17,5 cm (Grande)

Materiali:

Legno massello di rovere / noce canaletto / ciliegio / acero;
Cavo in acciaio



COAT HANGER

Solid wood coat hanger supported by a steel cable.

A light artefact that seems to hover in the space.

It defines a discreet presence with a strong evocative value.

It consists of a thin steel cable and a sort of hook to which either hanging clothes, hats, bags...

Dimensions:

H 12,5 cm (Small);

H 14 cm (Medium);

H 17,5 cm (Large)

Materials:

Solid oak wood / walnut / cherry / maple;
Steel cable



GRU

design: Giovanni Carboni

LAMPADA

Lampada a parete in legno massello.

Dimensioni:
L 180 x H 90 cm

Materiali:
Lampada e struttura: legno massello di rovere /
noce canaletto;
Ruota: legno massello di palissandro / rovere /
noce canaletto;
Contrappeso e piastre: acciaio satinato /
metallo laccato nero / metallo laccato ottone

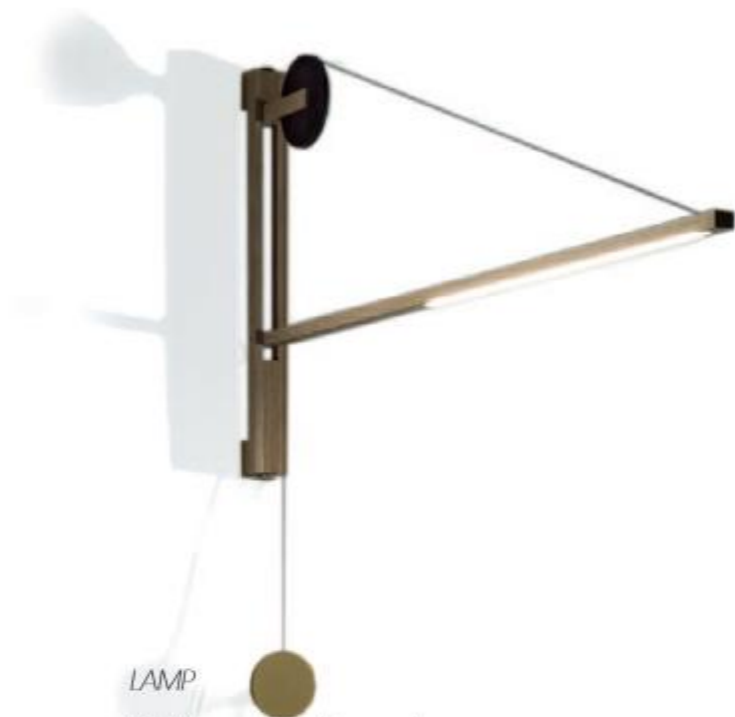

LAMP

Wall Lamp in solid wood.

Dimensions:
L 180 x H 90 cm

Materials:
Lamp and structure: solid oak wood / solid
canaletto walnut wood;
Wheel: rosewood solid wood / solid oak wood /
solid canaletto walnut wood;
Counterweight and plates: satin steel / black
lacquered metal / brass lacquered metal



DURAME®

DATI TECNICI

TECHNICAL DATA

BRIDGE 2 MOBILE CONTENITORE / CABINET

P. 12 - 15

VERSIONE CON DUE ANTE IN VETRO
VERSION WITH TWO GLASS DOORS

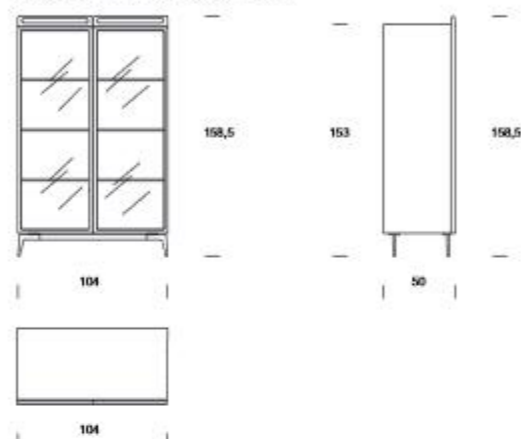

VERSIONE CON DUE ANTE IN VETRO + CASSETTO
VERSION WITH TWO GLASS DOORS + DRAWER

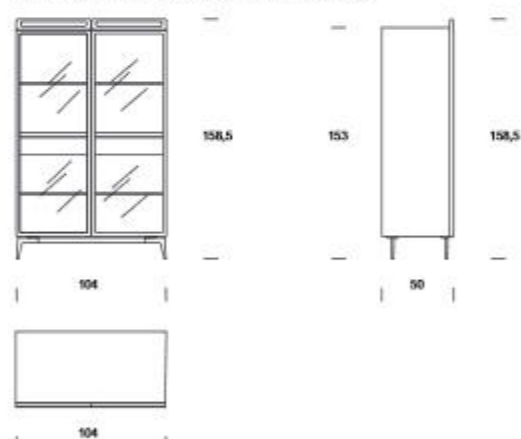

BRIDGE 3 MOBILE CONTENITORE / CABINET

P. 16 - 23

DUE ANTE ESTERNE IN LEGNO E UN'ANTA CENTRALE IN VETRO
TWO EXTERNAL WOODEN DOORS AND CENTRAL GLASS DOOR



DUE ANTE ESTERNE IN LEGNO E UN'ANTA CENTRALE IN VETRO + CASSETTO
TWO EXTERNAL WOODEN DOORS AND CENTRAL GLASS DOOR + DRAWER

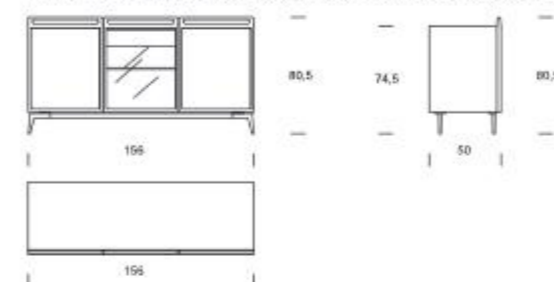

TRE ANTE IN VETRO
THREE GLASS DOORS

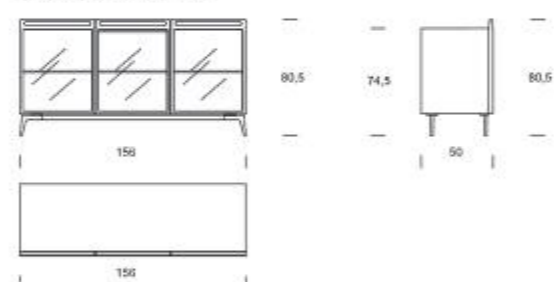

TRE ANTE IN VETRO + CASSETTO
THREE GLASS DOORS + DRAWER

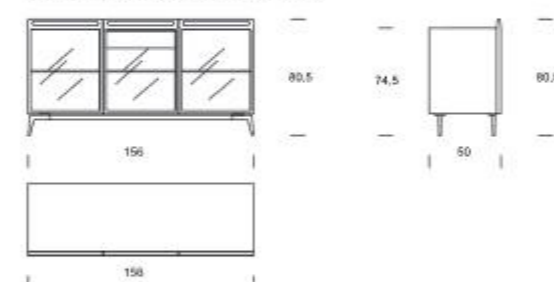

TRE ANTE IN LEGNO
THREE WOODEN DOORS

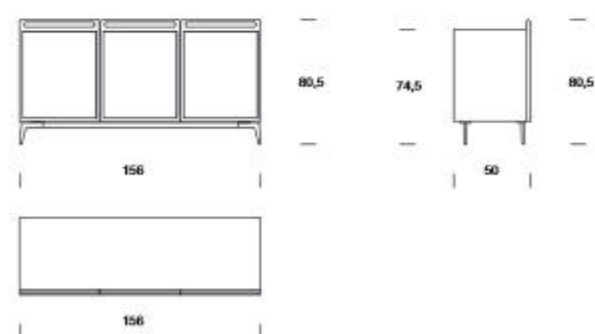

TRE ANTE IN LEGNO + CASSETTO
THREE WOODEN DOORS + DRAWER

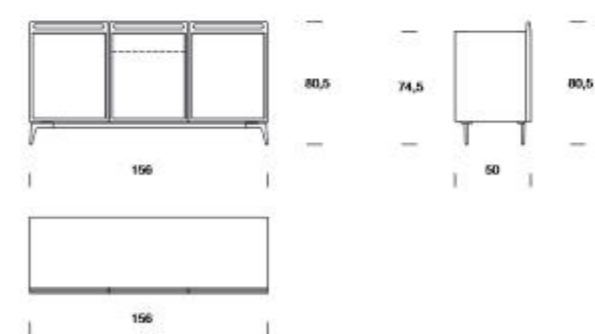

BRIDGE 4 MADIA/SIDEBOARD

P. 16 - 23

DUE ANTE ESTERNE IN LEGNO E DUE ANTE CENTRALI IN VETRO
TWO EXTERNAL WOODEN DOORS AND TWO CENTRAL GLASS DOORS

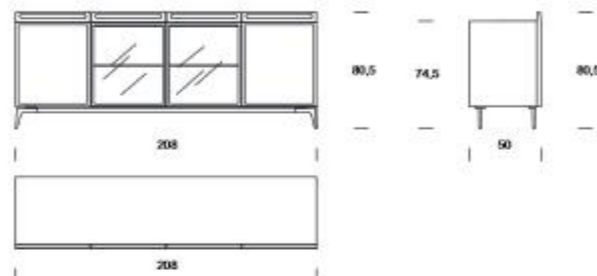

DUE ANTE ESTERNE IN LEGNO E DUE ANTE CENTRALI IN VETRO + CASSETTO
TWO EXTERNAL WOODEN DOORS AND TWO CENTRAL GLASS DOOR + DRAWER

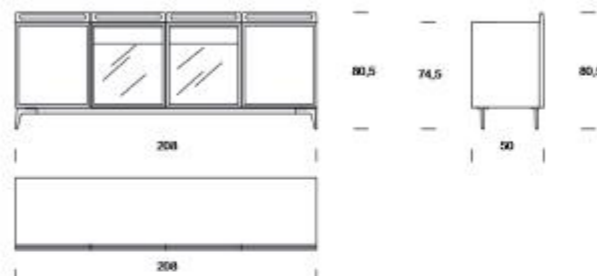

QUATTRO ANTE IN VETRO
FOUR GLASS DOORS

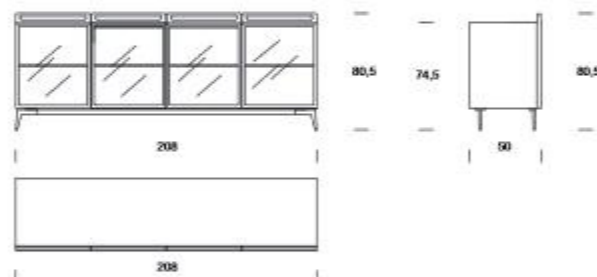

QUATTRO ANTE IN VETRO + CASSETTO
FOUR GLASS DOORS + DRAWER

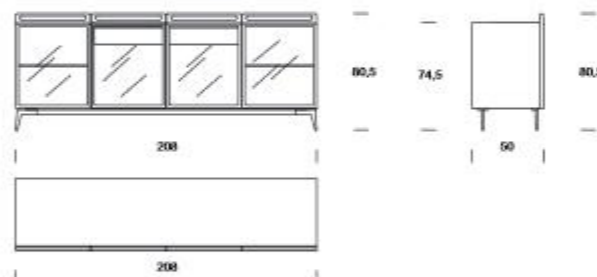

QUATTRO ANTE IN LEGNO
FOUR WOODEN DOORS

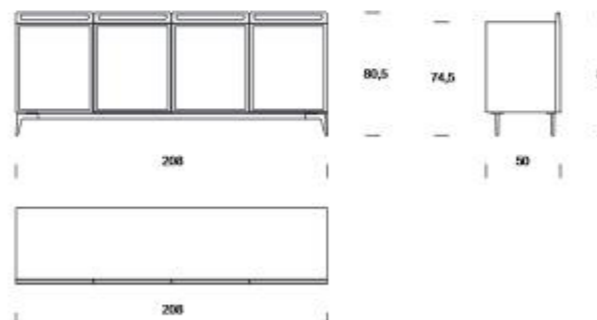

QUATTRO ANTE IN LEGNO + CASSETTO
FOUR WOODEN DOORS + DRAWER

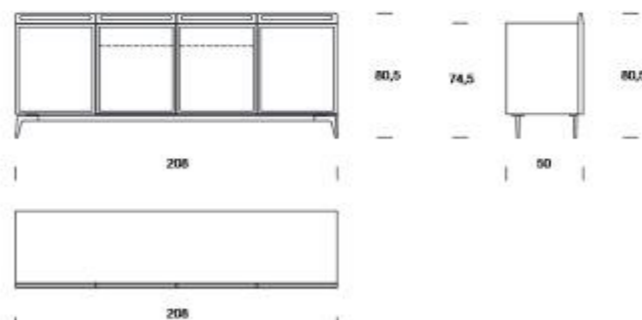

HONEY 2 MOBILE CONTENITORE/CABINET

P. 24 - 28

DUE ANTE + RIBALTA
TWO DOORS + FLAP

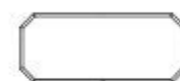
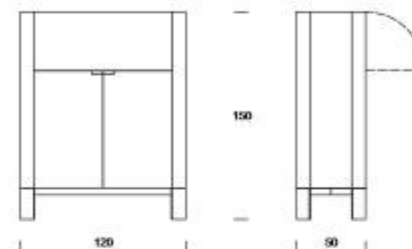

DUE ANTE + VANO GIORNO
TWO DOORS + DAY COMPARTMENT

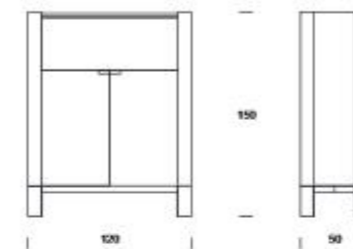

DUE ANTE CON CASSETTO + RIBALTA
TWO DOORS WITH DRAWER + FLAP

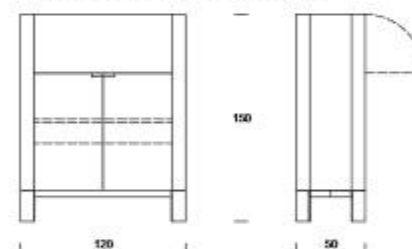

DUE ANTE CON CASSETTO + VANO GIORNO
TWO DOORS WITH DRAWER + DAY COMPARTMENT



DATI TECNICI | TECHNICAL DATA

HONEY 3 MOBILE CONTENITORE / CABINET

P. 29 - 35

TRE ANTE IN LEGNO
THREE WOODEN DOORS

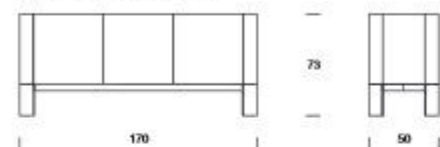

HONEY 4 MOBILE CONTENITORE / CABINET

P. 29 - 35

QUATTRO ANTE IN LEGNO
FOUR WOODEN DOORS

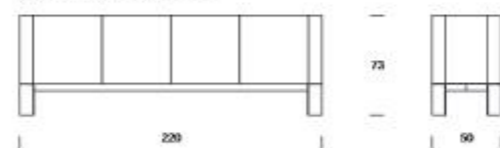

CRAB MOBILE CONTENITORE / CABINET

P. 36 - 39

TOP E ANTA IN GRES PORCELLANATO / PORCELAIN STONEWARE TOP AND DOOR

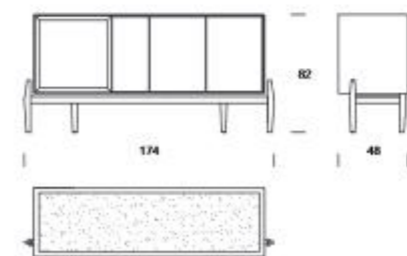
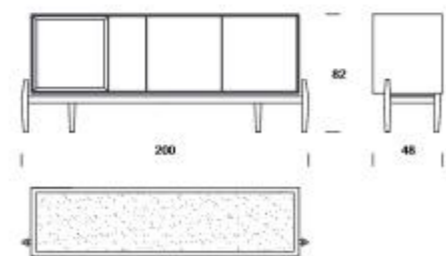
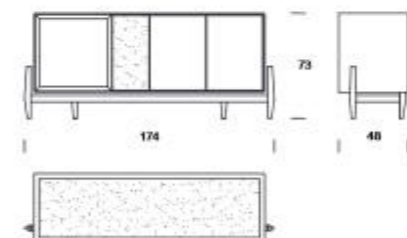
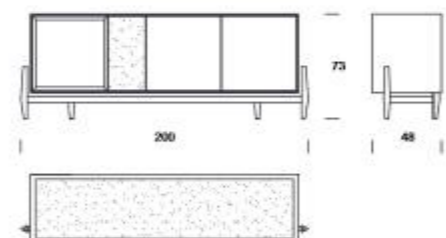
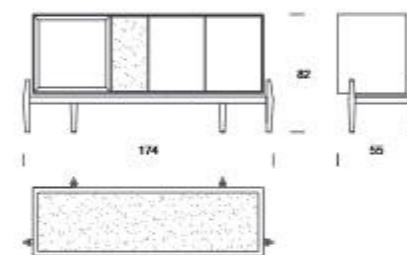
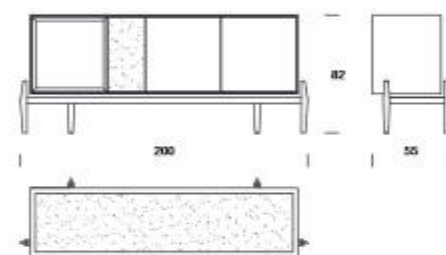
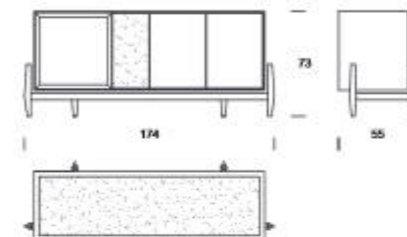
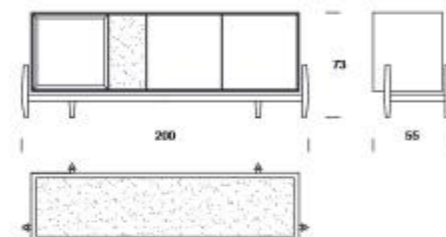

DATI TECNICI | TECHNICAL DATA

CRAB MOBILE CONTENITORE / CABINET

P. 36 - 39

TOP IN LEGNO E ANTA IN OTTONE / WOODEN TOP AND BRASS DOOR

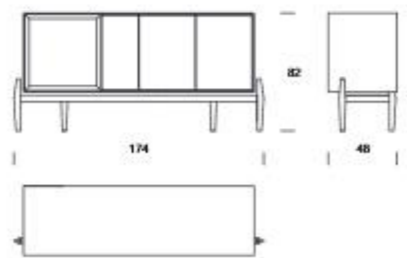
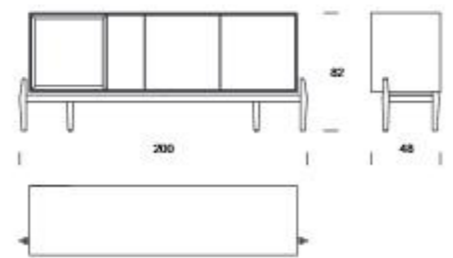
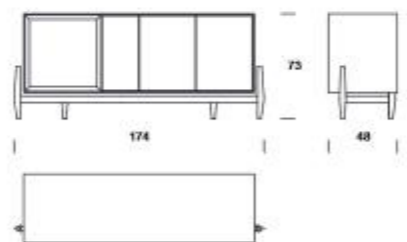
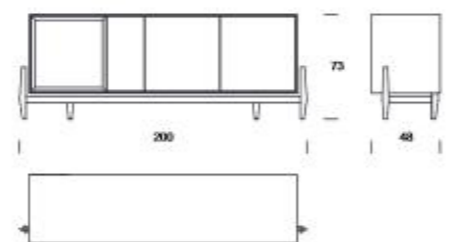
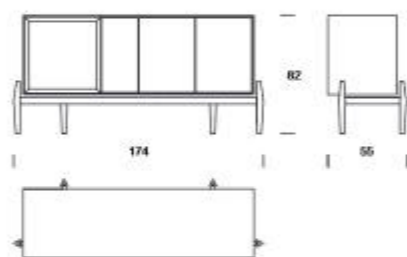
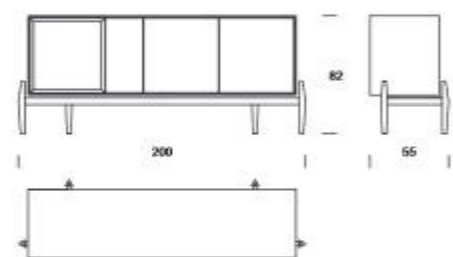
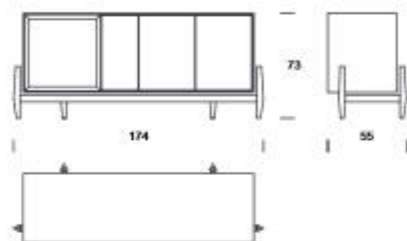
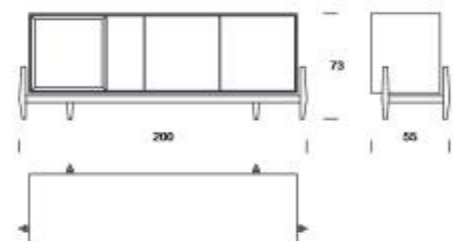

CRAB MOBILE CONTENITORE ALTO / HIGH CABINET

P. 40 - 41

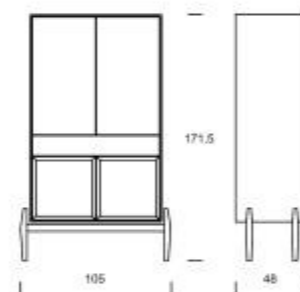
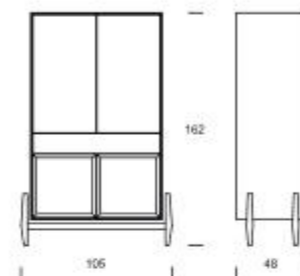

BREATHE MOBILE CONTENITORE / CABINET

P. 42 - 45

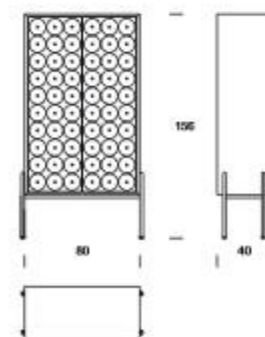

SINGOLO LIBRERIA/BOOKCASE

P. 46 - 49

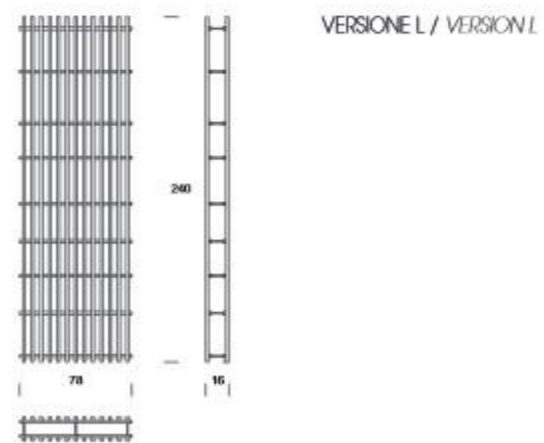
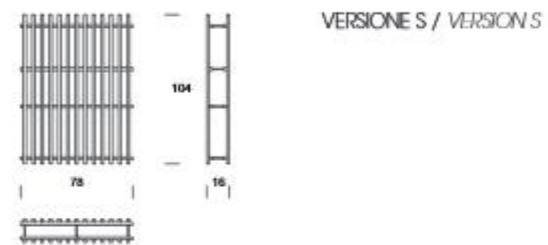

SINGOLO LIBRERIA/BOOKCASE

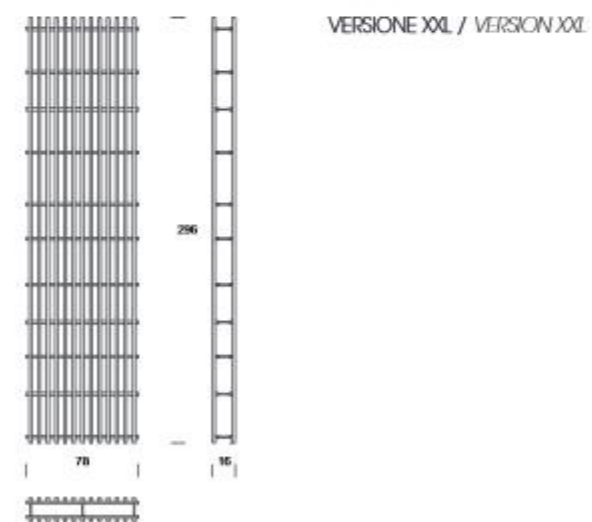
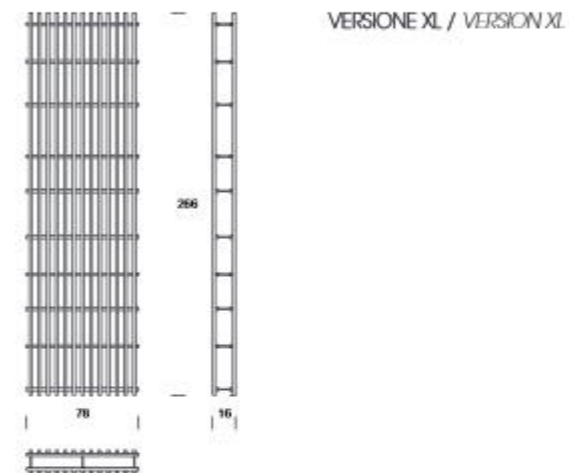

TOFANE LIBRERIA/BOOKCASE

P. 50 - 55

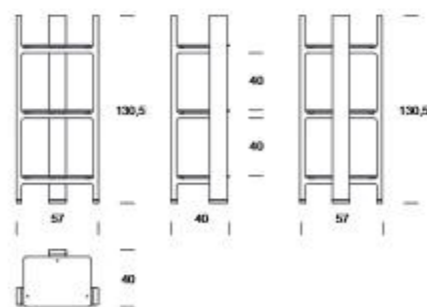
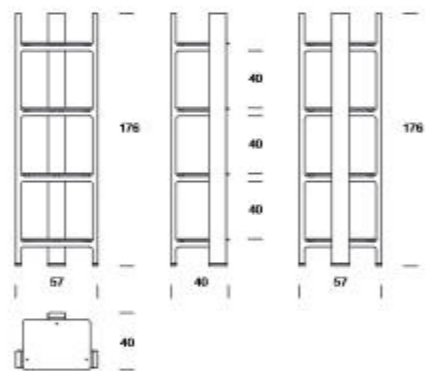
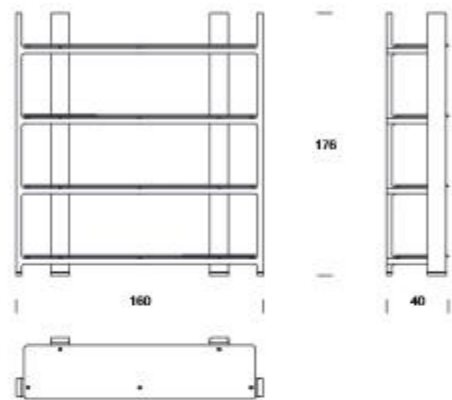

ELLA MADIA/SIDEBOARD

P. 56 - 57

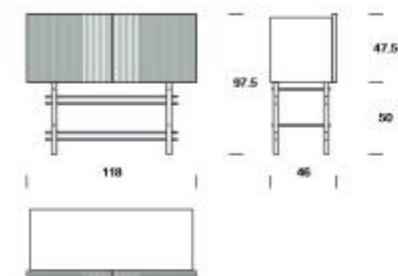

SIPARIO MOBILE CONTENITORE/CABINET

P. 58 - 61

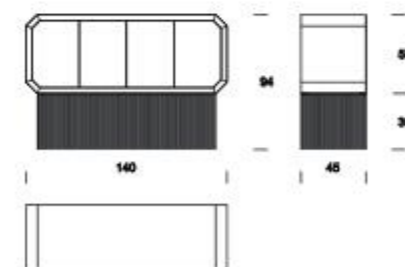
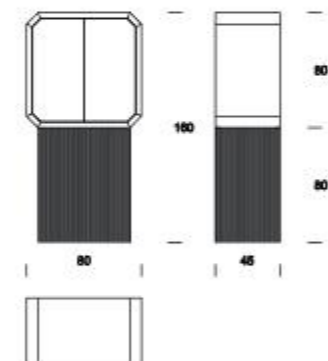

GROW LIBRERIA/BOOKCASE

P. 62-65

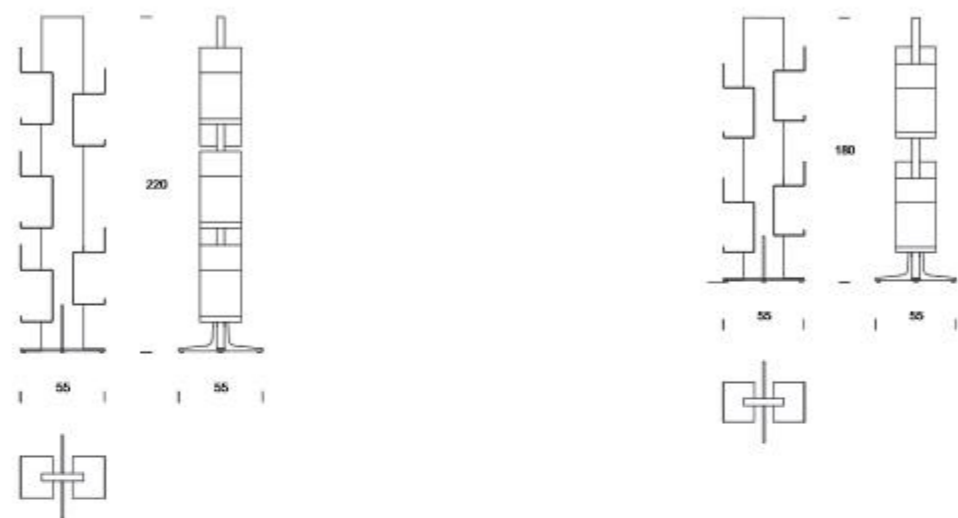

4x4Wood MOBILE CONTENITORE/CUPBOARD

P. 68-69

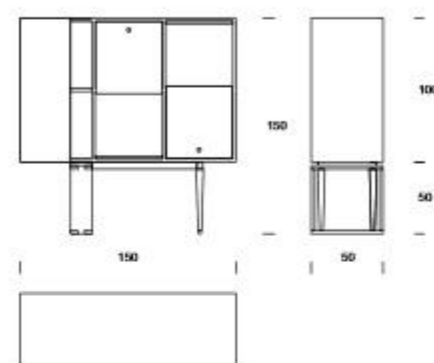

CAMINETTO MOBILE CONTENITORE/CABINET

P. 66-67

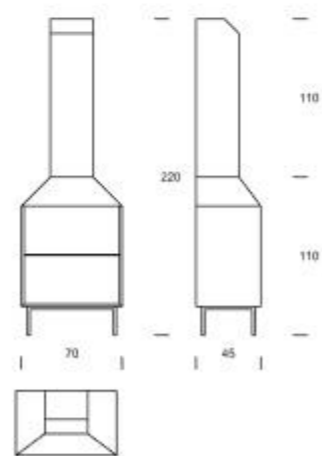

ASTEROID LIBRERIA/BOOKCASE

P. 70-71

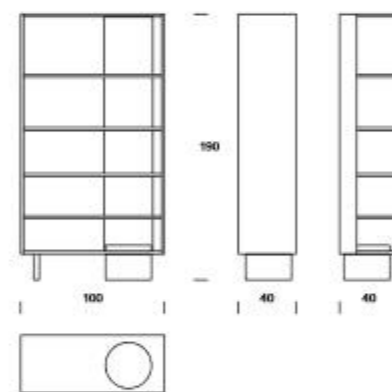

HIVE LIBRERIA/BOOKCASE

P. 72-73

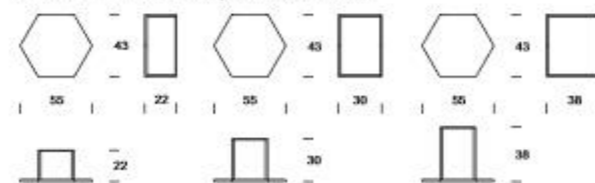

DATI TECNICI | TECHNICAL DATA

DIAMANTE TAVOLO / TABLE

P. 76-81

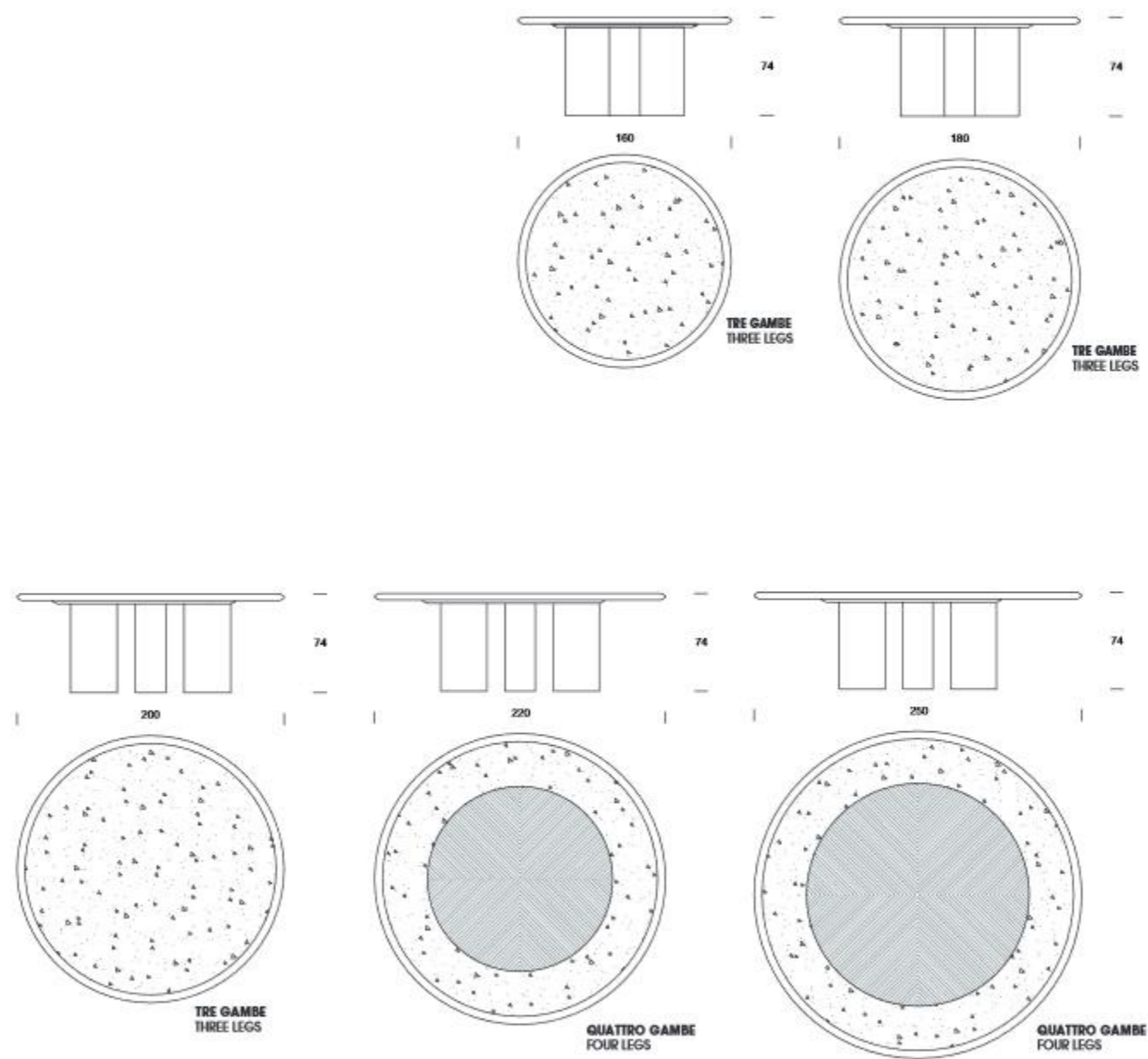

VUOTO TAVOLO / TABLE

P. 82-87

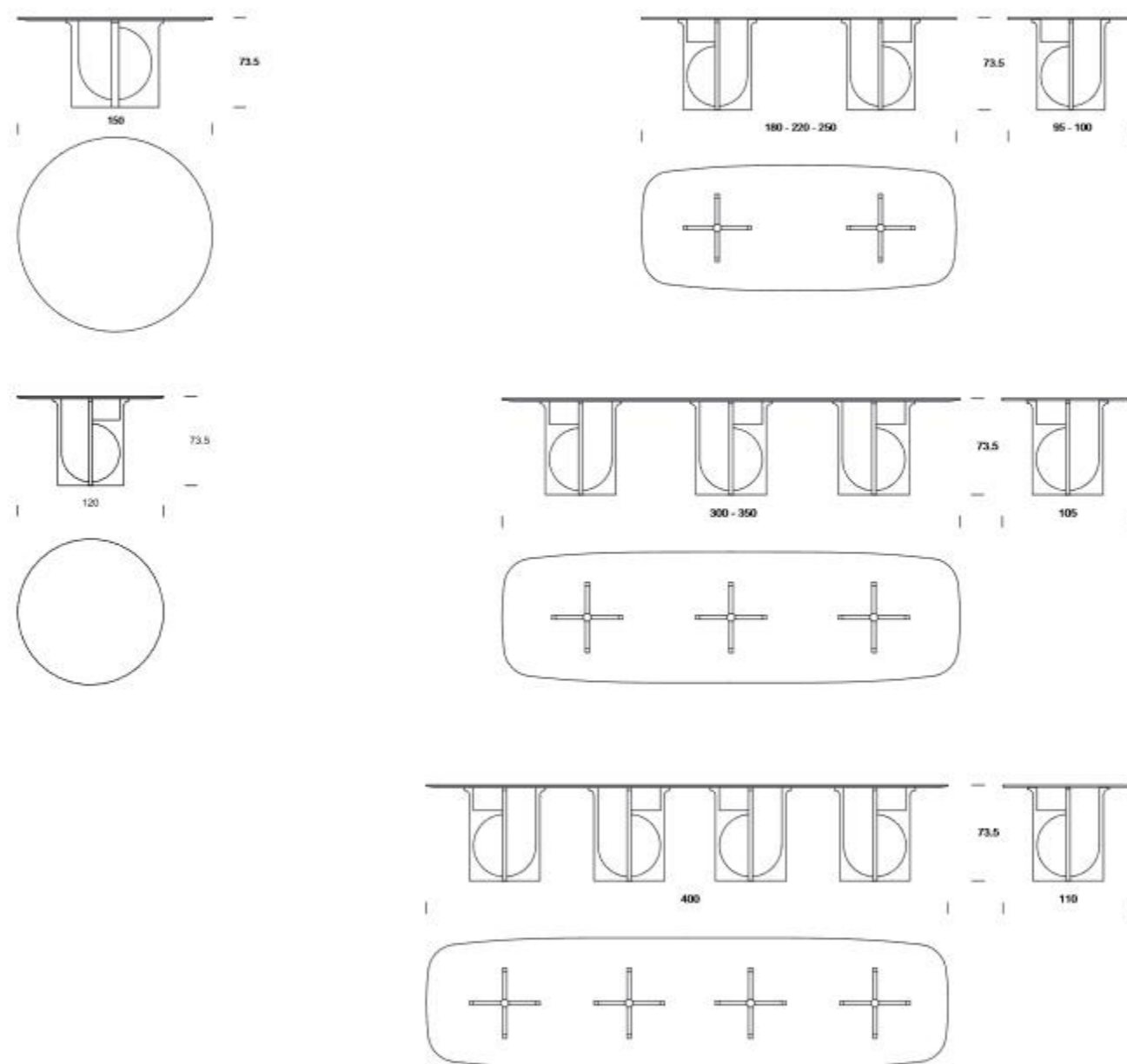

DATI TECNICI / TECHNICAL DATA

RENAISSANCE TAVOLO / TABLE

P. 88 - 93



DRY TAVOLO / TABLE

P. 94 - 95

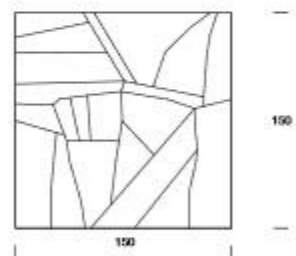
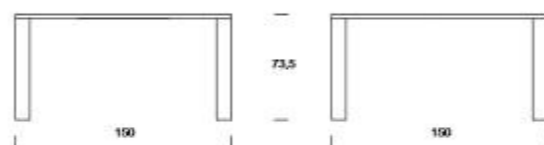

GAB TAVOLO / TABLE

P. 96 - 97



DON TAVOLO / TABLE

P. 98 - 99

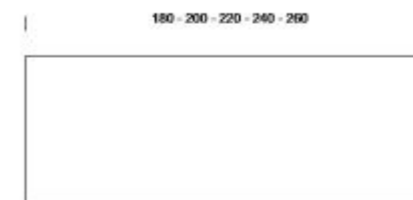
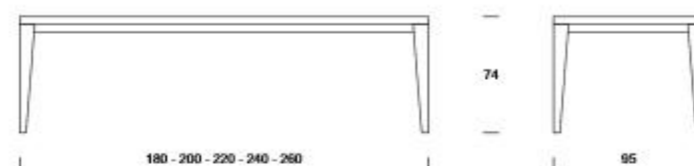

TA.ta wood TAVOLO / TABLE

P. 100 - 101

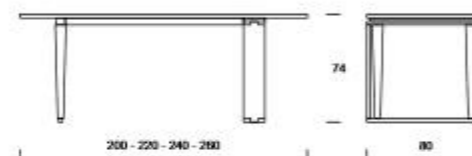

ICS TAVOLO / TABLE

P. 102 - 103

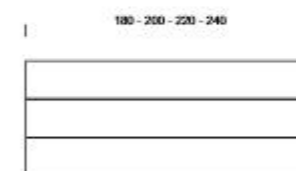
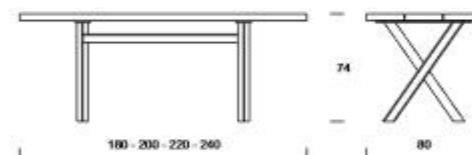

TUB TAVOLO / TABLE

P. 104 - 105

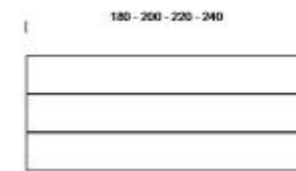
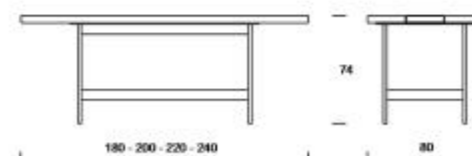

DATI TECNICI / TECHNICAL DATA

TEA TAVOLINO CONTENITORE / CONTAINER SIDE TABLE

P. 108 - 111

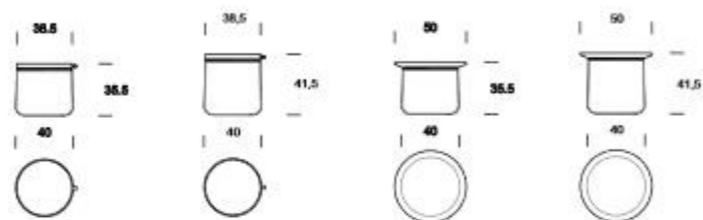

JEAN ORDINARY TAVOLINO / SIDE TABLE

P. 112 - 115

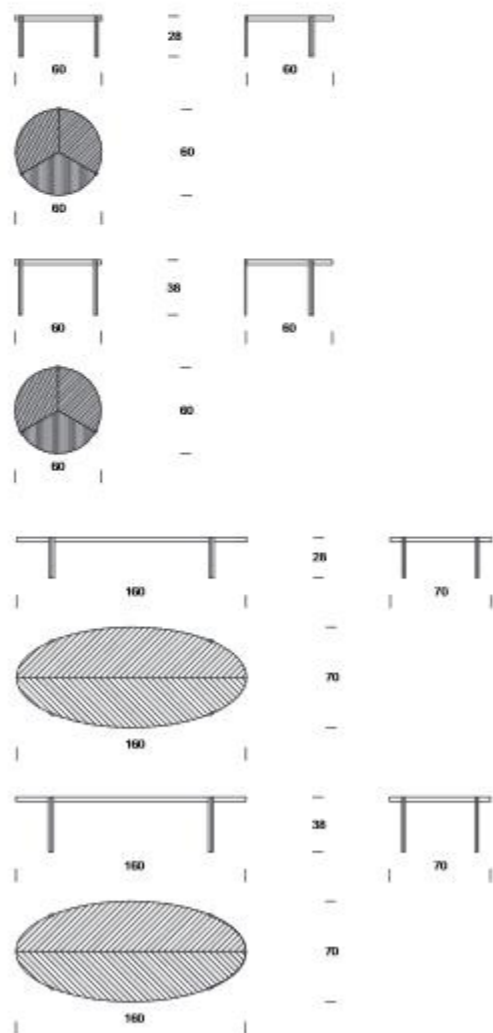

JEAN TAVOLINO / SIDE TABLE

P. 116 - 119

VERSIONE GAMBE IN OTTONE / BRASS LEGS VERSION

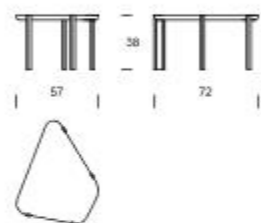
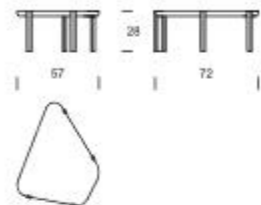

JEAN VERSIONE GAMBE IN FERRO LACCATO NERO / JEAN LEGS VERSION IN BLACK LACQUERED IRON

VERSIONE GAMBE IN OTTONE / BRASS LEGS VERSION

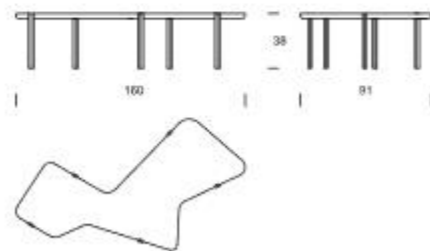
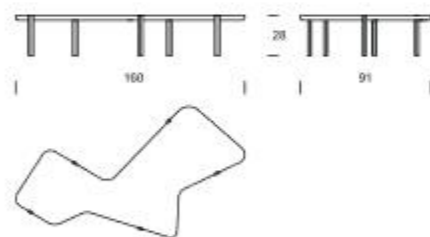

JEAN VERSIONE GAMBE IN FERRO LACCATO NERO / JEAN LEGS VERSION IN BLACK LACQUERED IRON

DATI TECNICI | TECHNICAL DATA

MOON TAVOLINO/SIDE TABLE

P. 120 - 121

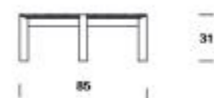

JOKER TAVOLINO/SIDE TABLE

P. 122 - 123



BMO TAVOLINO/SIDE TABLE

P. 124 - 125



DRY side table TAVOLINO/SIDE TABLE

P. 126 - 127



NAZCA TAVOLO BASSO/LOW TABLE

P. 128 - 129

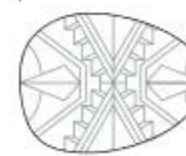
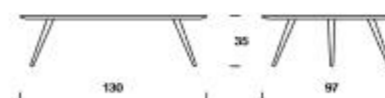

DATI TECNICI | TECHNICAL DATA

KURTZ TAVOLINO / SIDE TABLE

P. 130 - 131

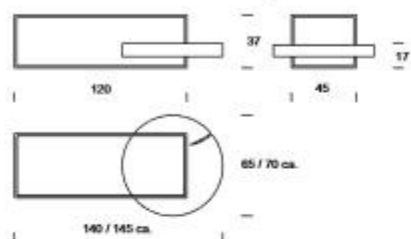

MARLOW TAVOLINO / SIDE TABLE

P. 132 - 133

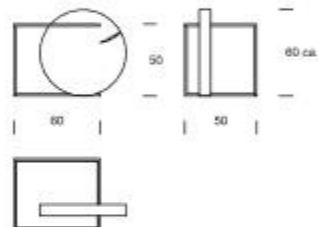

TOC TAVOLINO / SIDE TABLE

P. 134 - 135

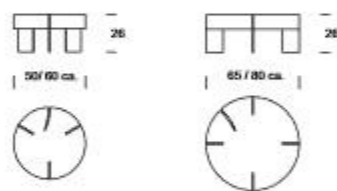

InstABLE TAVOLINO / COFFEE TABLE

P. 136 - 137

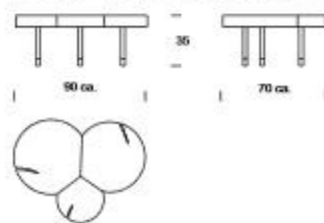

BUTTER TOILETTA MOBILE TOILETTA / DRESSING TABLE

P. 140 - 143

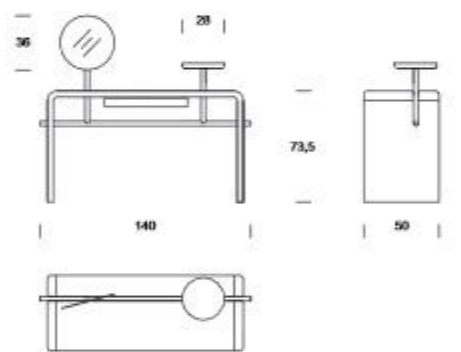
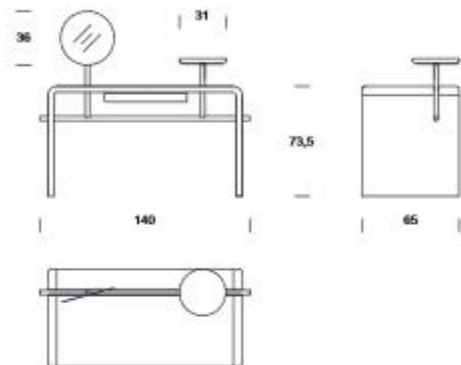

DATI TECNICI | TECHNICAL DATA

HERMITAGE DIVANO/SOFA

P. 146 - 151

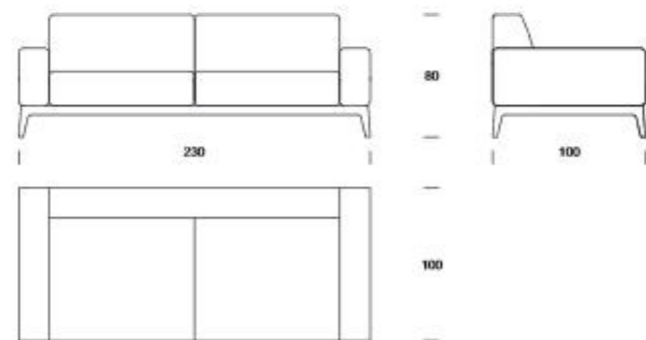
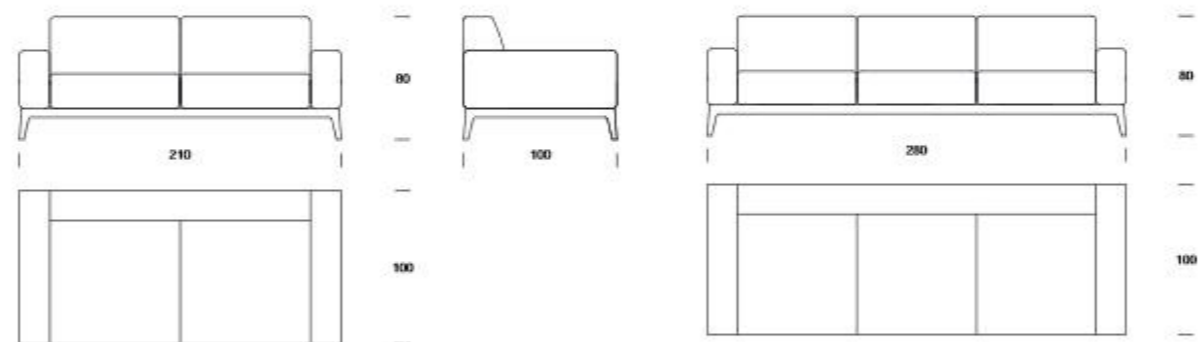
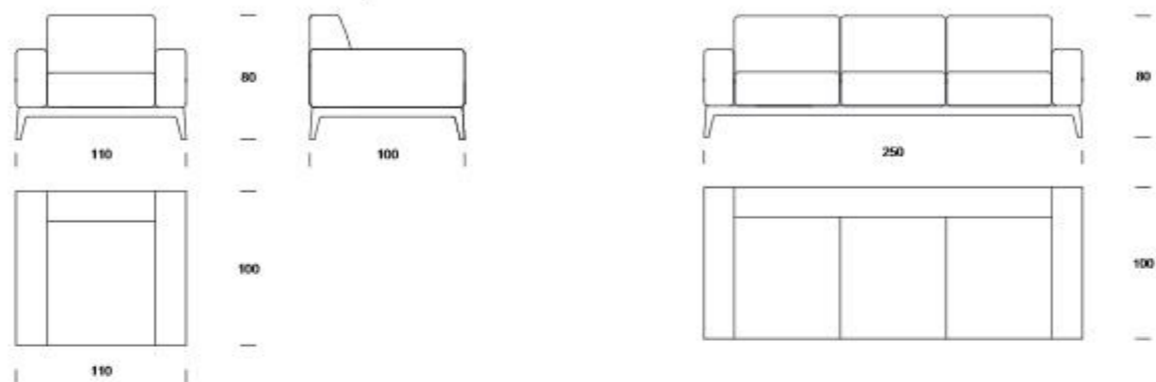

GAZZELLA POLTRONA/ARMCHAIR

P. 152 - 155

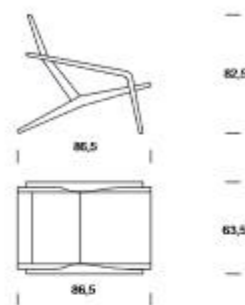

MILLEMIGLIA SUPER POLTRONA/ARMCHAIR

P. 156 - 159

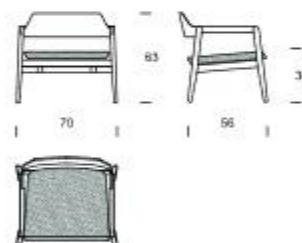

MILLEMIGLIA SEDIA/CHAIR

P. 160 - 163

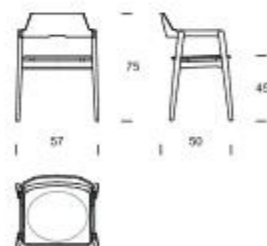

DATI TECNICI / TECHNICAL DATA

GRETA POLTRONA / ARMCHAIR

P. 164 - 169



CROSS SEDIA / CHAIR

P. 170 - 173

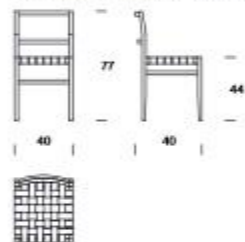

CROSS POLTRONCINA / ARMCHAIR

P. 174 - 175



CROSS POGGIAPIEDI / FOOTREST

P. 174 - 175



EXPERIMENTA POLTRONA / ARMCHAIR

P. 176 - 179

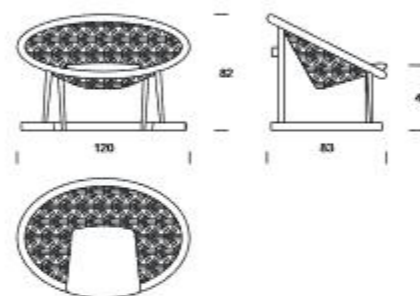

BUTTER Bench PANCHINA / BENCH

P. 180 - 181

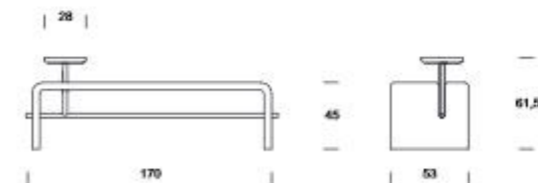
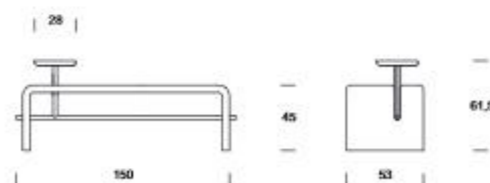
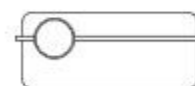
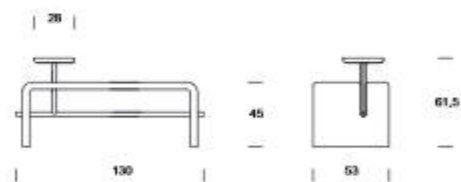

DATI TECNICI | TECHNICAL DATA

JEAN DAYBED

P. 182 - 185

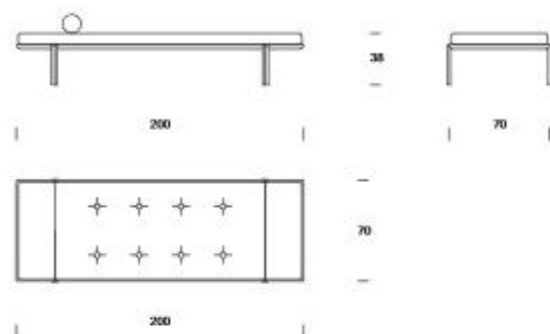

b2b PANCA/PORTARIVISTE-LIBRI/BENCH/MAGAZINE-BOOK RACK

P. 186 - 187

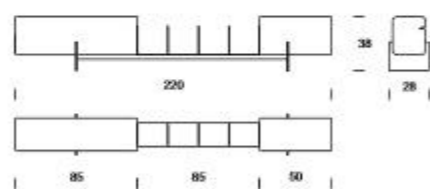
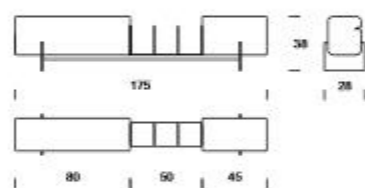

DEAR POUFF/POUFF

P. 188 - 189

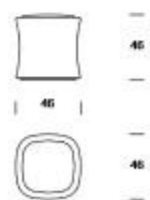

GRAFT SEDIA/CHAIR

P. 190 - 193

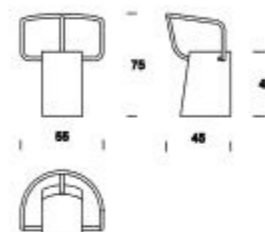

SEMUC SGABELLO/STOOL

P. 176 - 179

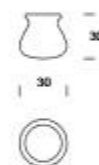

VERSIONE SMALL / VERSION SMALL

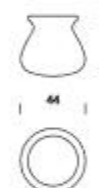

VERSIONE LARGE / VERSION LARGE

DATI TECNICI / TECHNICAL DATA

BRIDGE Bed LETTO / BED

P. 198 - 201

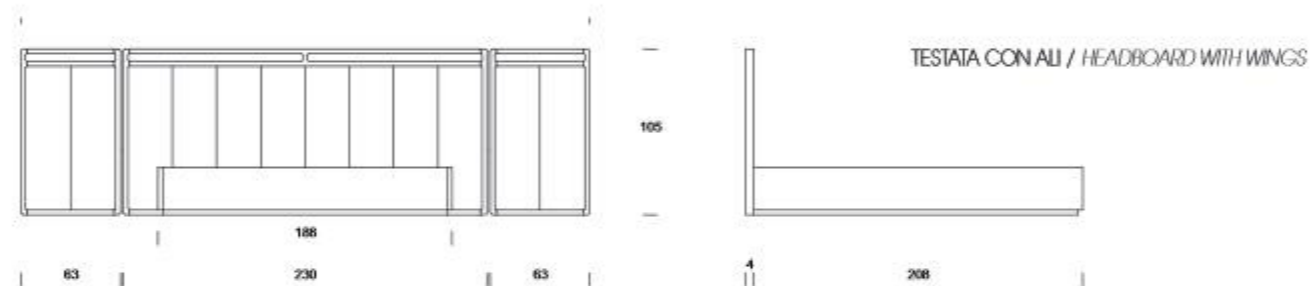
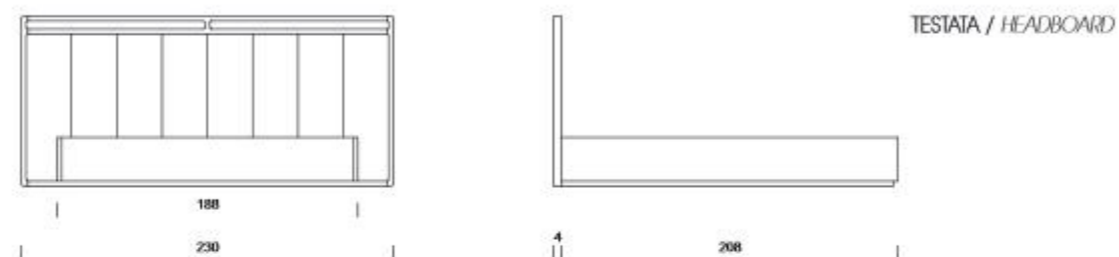

IRPIN SPECCHIO / MIRROR

P. 204 - 207

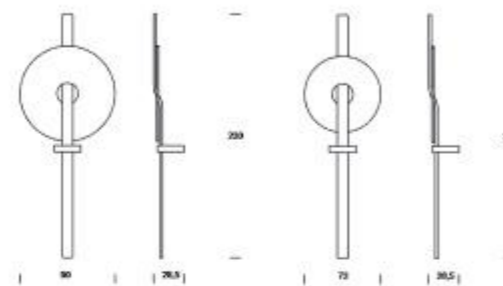

OBLIQUE SPECCHIO / MIRROR

P. 208 - 209



DATI TECNICI | TECHNICAL DATA

EDES SPECCHIO / MIRROR

P. 210 - 211



ETNA SPECCHI / MIRRORS

P. 212 - 213

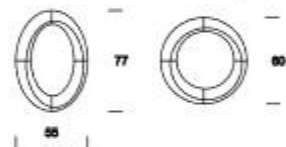

SEED APPENDIABILI / COAT HANGER

P. 214 - 215

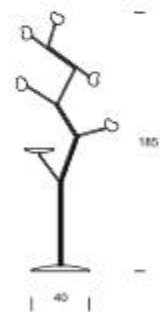

PLANETS APPENDIABILI / COAT HANGER

P. 216 - 217



AMO GANCIO APPENDIABILI / COAT HANGER

P. 218 - 219

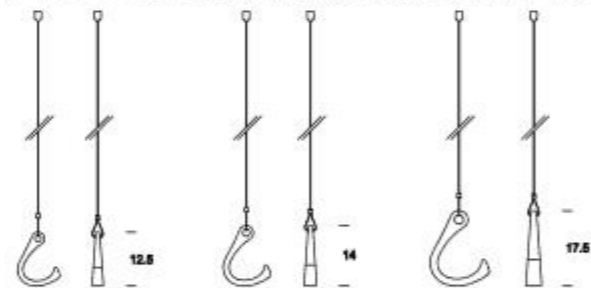

GRU LAMPADA / LAMP

P. 220 - 221

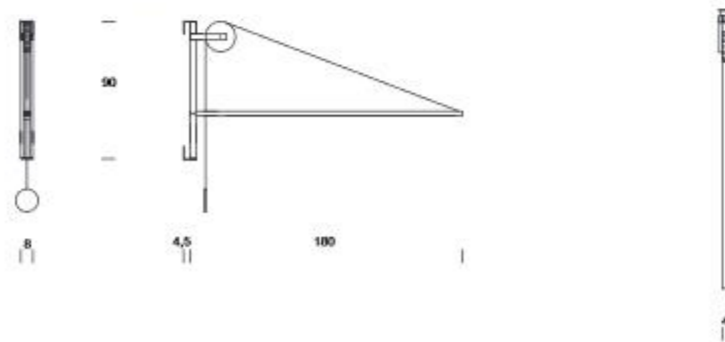







DURAME®

INDICE

INDEX

INDICE INDEX

10 - 73 CONTENITORI STORAGE UNITS

BRIDGE 2	12 - 13
BRIDGE 3/4	16 - 23
HONEY 2	24 - 28
HONEY 3/4	29 - 35
CRAB	36 - 39
CRAB ALTO	40 - 41
BREATHE	42 - 45
SINGOLO	46 - 49
TOFANE	50 - 55
ELLA	56 - 57
SIPARIO	58 - 61
GROW	62 - 65
CAMINETTO	66 - 67
4x4Wood	68 - 69
ASTEROID	70 - 71
HIVE	72 - 73

74 - 105 TAVOLI TABLES

DIAMANTE	76 - 81
VUOTO	82 - 87
RENAISSANCE	88 - 93
DRY	94 - 95
GAB	96 - 97
DON	98 - 99
TA.ta wood	100 - 101
ICS	102 - 103
TUB	104 - 105

106 - 137 TAVOLINI LOW TABLES

TEA	108 - 111
JEAN ORDINARY	112 - 115
JEAN	116 - 119
MOON	120 - 121
JOKER	122 - 123
BIVIO	124 - 125
DRY side table	126 - 127
NAZCA	128 - 129
KURTZ	130 - 131
MARLOW	132 - 133
TOC	134 - 135
InsTABLE	136 - 137

138 - 143 SCRIVANIE CONSOLE

BUTTER Toiletta	140 - 143
-----------------	-----------

INDICE INDEX

144 - 195 SEDUTE SEATINGS

HERMITAGE	146 - 151
GAZZELLA	152 - 155
MILLEMIGLIA SUPER	156 - 159
MILLEMIGLIA	160 - 163
GRETA	164 - 169
CROSS CHAIR	170 - 173
CROSS ARMCHAIR	174 - 175
CROSS POGGIAPIEDI	174 - 175
EXPERIMENTA	176 - 179
BUTTER Bench	180 - 181
JEAN DAYBED	182 - 185
GRAFT	172 - 175
SEMUC	176 - 179
b2b	186 - 187
DEAR	188 - 189
GRAFT	190 - 193
SEMUC	194 - 195

196 - 201 LETTI BEDS

BRIDGE Bed	198 - 201
------------	-----------

202 - 221 COMPLEMENTI COMPLEMENTS

IRPIN	204 - 207
OBLIQUE	208 - 209
EDES	210 - 211
ETNA	212 - 213
SEED	214 - 215
PLANETS	216 - 217
AMO	218 - 219
GRU	220 - 221

222 - 257 DATI TECNICI TECHNICAL DATA

DURAME[®]

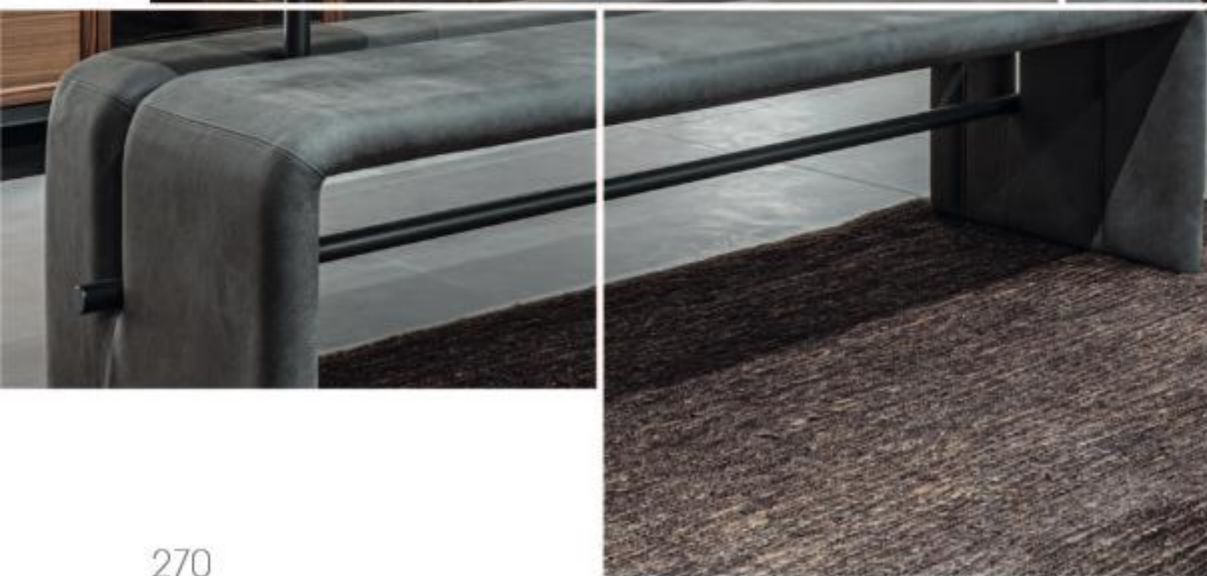

Durame si riserva il diritto di apportare in qualsiasi momento e senza alcun preavviso, modifiche tecniche, dimensionali ed estetiche che ritenga necessarie per un miglioramento funzionale e qualitativo dei propri prodotti. Testi e disegni presenti in questo stampato hanno scopo divulgativo: per ogni aspetto tecnico e dimensionale fare riferimento ai listini aziendali e relativi aggiornamenti. Le possibili differenze di tonalità o sfumature di colore sono da considerarsi caratteristiche naturali dei materiali a dimostrazione dell'artigianalità della lavorazione. I campioni di colori e materiali hanno valore indicativo.

Durame reserves the rights to apply technical/dimensional/aesthetic amendments for a functional and qualitative improvements of its products, at any time and without any notice obligation. Texts and drawings present in this catalogue have a divulgative purpose: for every technical and dimensional aspect please refer to the company's price lists and their relative updates. Differences in color tonality or shades are to be considered natural characteristic of the materials and a demonstration of the crafted processing. Color and material samples have an indicative value.



Explore our
new website

GRAPHIC:
studio grafico
ruggiero marelli | cantù

PHOTOGRAPHY:
studio eleven | mariano c.se

A.D.:
crs DURAME | cantù

07.2022 - #5

DURAME[®]

Via dell' Artigianato 20
22063 Cantù (CO) Italy
Telefono/Fax 031 734910
info@durame.it
www.durame.it

