

**T**

WARDROBE SYSTEM

---

YOUR  
PERSONAL  
SPACE

**TUMIDEI**<sup>®</sup>

**TUMIDEI®**

ARMADI  
WARDROBES  
**2020**

---

**3** BATTENTE / ANTA TELAIO  
HINGED / FRAMED DOOR

**39** BATTENTE / ANTA LISCIA  
HINGED / PLAIN DOOR

**115** CABINE ARMADI  
WALK-IN-CLOSET

**147** ANTA SCORREVOLE  
SLIDING DOOR

**167** DATI TECNICI  
TECHNICAL DATA

**265** FINITURE  
FINISHING

T



ARMADI  
WARDROBES  
2020

BATTENTE / ANTA TELAIO  
HINGED / FRAMED DOOR  
/

Componibili, personalizzabili, gli armadi ad anta battente Tumidei sono elementi di architettura adattabili alle necessità di chi li utilizza. Il sistema di ante tradizionali si trasforma in un gioco di colore e finiture, Vetri e pattern dalla spiccata personalità.

*Modular, customizable, Tumidei hinged doors wardrobes are architectural elements which can be customized and adjusted according to one's needs. The traditional doors system turns into a play of colours and finishes, glasses and patterns with a strong personality.*



**Alcova** oltre ad altre molteplici versioni, può essere configurata nella versione armadio con ante vetro a soffietto con o senza stampa digitale a righe. Disponibile nella vasta gamma di finiture, in nobilitato, laccato ed essenza.

**Alcova**, besides further multiple versions, can be configured as a wardrobe with folding glass doors with or without stripes digital print. Available in a wide selection of melamine, lacquered and wood finishes.



Struttura armadio nobilitato noce, ante armadio laccato nero opaco 20, maniglie push-pull, **Alcova** cornice nobilitato noce, ante a soffietto in vetro con stampa digitale riga nera, **Isola** con cassetti e raster essenza rovere carbone.

*Wardrobe structure in noce melamine, wardrobe doors in nero 20 lacquered, push-pull handles, **Alcova** frame in noce melamine, folding glass doors with horizontal black stripes digital print **Isola** chest of drawers in rovere carbone wood.*





#### SOLUTION A

Struttura armadio nobilitato olmo scuro  
 fianchi esterni laccati tortora78  
 Maniglie push-pull

**Alcova** cornice nobilitato olmo scuro  
 Ante a soffietto in vetro fumè

*Wardrobe structure in tortora melamine  
 Wardrobe doors in tortora 78 melamine  
 Push-pull handles*

**Alcova** frame in olmo scuro melamine  
 Folding doors in smoked glass



#### SOLUTION B

Struttura armadio nobilitato olmo bio  
 Ante armadio nobilitato olmo bio  
 Maniglie push-pull

**Alcova** cornice laccato cappuccino 41  
 Ante a soffietto in vetro fumè

*Wardrobe structure in olmo bio melamine  
 Wardrobe doors in olmo bio melamine  
 Push-pull handles*

**Alcova** frame in cappuccino 41 lacquered  
 Folding doors in smoked glass



#### SOLUTION C

Struttura armadio nobilitato trama tessuto  
 Ante e fianchi esterni armadio laccato 46 muschio  
 Maniglie push-pull

**Alcova** cornice ed interno essenza rovere fumè  
 Ante a soffietto in vetro fumè

*Wardrobe structure in trama tessuto melamine  
 Wardrobe doors in muschio 46 lacquered  
 Push-pull handles*

**Alcova** frame and inner parts in rovere fumè wood  
 Folding doors in smoked glass





**ISOLA** SYSTEM

**Isola** bifacciale con cassetti e raster, top in legno sp.4 cm in essenza rovere carbone e vetro extrachiaro sp.1 cm

*Double-sided Isola with drawers and raster, wooden top th. 4 cm in rovere carbone wood and extra-clear glass th. 1cm*





Armadio con ante vetro con telaio alluminio nero e pellicola tessuto semitrasparente applicata 02 Rock, struttura e fianchi armadio nobilitato olmo grigio, boiserie sp15 e mensole sp7.5 cm folding essenza rovere fumè.

Wardrobe with aluminium black framed glass doors and semi-transparent raised fabric 02 Rock Structure and sides in olmo grigio melamine, wall panel sp15 and folding shelves th. 7,5cm in rovere fumè wood.





Struttura armadio nobilitato  
olmo scuro, ante armadio  
laccato cappuccino  
41, maniglie push-pull,  
**Window** seduta nobilitato  
olmo scuro con cuscino e  
stampa digitale tessuto WD  
437-05, modulo Open con  
ripiani vetro extrachiaro e  
stampa digitale wd 437-05

*Wardrobe structure in  
olmo scuro melamine.  
Wardrobe doors in  
cappuccino 41 lacquered  
Push-pull handles,  
**Window** seduta in olmo  
scuro melamine with seat  
cushion and WD 437-05  
fabric digital print Open  
unit with glass shelves and  
WD 437-05 digital print.*

Elemento terminale **Stand** art STF13 con specchio e vano a giorno in folding laccato cappuccino 41 con ripiani vetro, tavolino **Stick** alto in metallo nero con top in vetro laccato, tavolino **Stick** intermedio in metallo nero con top in vetro laccato.

**Stand** art STF13 end unit with mirror and folding open box in cappuccino 41 lacquered with glass shelves **Stick** high coffee-table with black metal structure and lacquered glass top **Stick** intermediate coffee table with black metal structure and lacquered glass top.



**STICK** COFFEE TABLE

Tavolino **Stick** alto in metallo nero con top in vetro laccato, tavolino **Stick** intermedio in metallo nero con top in vetro laccato biscotto 09, tavolino **Stick** basso in metallo nero con top in vetro laccato con stampa digitale WD MAR 002.

***Stick** high coffee-table with black metal structure and lacquered glass top  
**Stick** intermediate coffee table with black metal structure and lacquered biscotto 09 glass top, **Stick** low coffee table with black metal structure and glass top with WD MAR 002 digital print.*





Armadio con ante vetro fumè con telaio alluminio nero, ante e fianchi esterni finali laccato lucido lavagna 50, struttura in nobilitato pelle antracite, schiene con stampa digitale WD 369-01.

Wardrobe with aluminium black framed smoked glass doors. Doors and end sides in lavagna 50 glossy lacquered, structures in pelle antracite melamine, backs with digital print WD 369-01.



Armadio **Cristal** con fianco e ante telaio alluminio color bronzo con vetro extrachiario temperato, schiene vetro extrachiario, ripiani telaio alluminio color bronzo con vetro extrachiario, base cappello armadio e cassetiera **Cristal** nobilitato olmo scuro, affiancato ad armadio con ante legno.

**Cristal** wardrobe with side and door with bronzed aluminium frame and extra-clear tempered glass. Backs in extra-clear glass. Shelves with bronzed aluminium frame and extra-clear glass, base top and **Cristal** chest of drawers in olmo scuro melamine, combined with wooden doors wardrobe.

Letto **Tender** in tessuto MIZ006, giroletto e testata sfoderabili.  
Comodino **Circle** laccato caffè 29 .

***Tender** bed with MIZ006 fabric. Bedstead and headboard fabrics are fully removable.  
**Circle** night table in caffè 29 lacquered.*





Colonna angolo **Carry** in nobilitato olmo scuro, colonne con ante a soffietto laccato lucido caffè 29, schiene con stampa digitale WD KIR 7806-03 maniglia **Line** caffè 29 con divisore telaio **Cristal**.

**Carry** corner closet in olmo scuro melamine, wardrobe columns with folding doors in caffè 29 glossy lacquered, backs with WD KIR 7806-03 digital print, **Line** handle in caffè 29 lacquered with **Cristal** framed partition.



Vano interno armadio  
con ante a soffietto  
con fianco telaio alluminio  
color bronzo.  
Schiena con stampa  
digitale wd KIR7806-03.

*Folding doors internal unit  
with bronzed aluminium  
framed side.  
Back with digital print  
wd KIR 7806-03.*





Armadio **Cristal** con fianco e ante telaio alluminio color bronzo e vetro extrachiario temperato.  
Base, cappello e cassettera in nobilitato olmo scuro.

**Cristal** wardrobe with side and door with bronzed aluminium frame and extra-clear tempered glass.  
Base, top and chest of drawers in olmo scuro melamine.





Armadio **Cristal** con fianco e ante telaio alluminio color bronzo con vetro extrachiaro temperato, schiene nobilitato con stampa digitale WD 362, ripiani telaio alluminio color bronzo con vetro extrachiaro, base cappello armadio e cassettera **Cristal** nobilitato olmo scuro.

*Cristal wardrobe has its sides and door with bronzed aluminium frame and extra-clear tempered glass. Backs in melamine with digital print WD 362, shelves with bronzed aluminium frame and extra-clear glass. Base top and **Cristal** chest of drawers in olmo scuro melamine.*



Armadio **Cristal** con fianco e ante telaio alluminio color bronzo e vetro fumè temperato con stampa digitale righe nere orizzontali, ripiani telaio alluminio color bronzo e vetro extrachiaro, base cappello armadio in nobilitato noce e cassetiera **Cristal** laccato lavagna 50.

**Cristal** wardrobe with side and door with bronzed aluminium frame and smoked tempered glass with horizontal black stripes digital print. Shelves with bronzed aluminium frame and extra-clear glass, base top in noce melamine and **Cristal** chest of drawers in lavagna lacquered 50.

**Alcova** LRI41RT con seduta  
cornice **Alcova** laccato  
lavagna 50, ante battenti  
laccato ghiaccio 42, anta  
ribalta superiore **Alcova**  
PEA07 laccato ghiaccio 42.

**Alcova** LRI41RT with seat  
cushion. **Alcova** frame  
in lavagna lacquered 50,  
hinged doors in ghiaccio  
lacquered 42, upper tilt  
door **Alcova** PEA07 in  
ghiaccio lacquered 42.



T

ARMADI  
WARDROBES  
2020

BATTENTE / ANTA LISCIA  
HINGES / PLAIN DOOR  
/

Versatilità e modularità, sono le caratteristiche degli armadi ad anta battente, sfruttano al meglio la profondità dei volumi per avere il massimo dello stoccaggio, ed agevolano l'organizzazione degli elementi interni.

*Flexibility and modularity are the main features of hinged doors wardrobes. Thus taking full advantage of the depth of each volume for storage, ultimately improving internal elements organization.*



**Alcova** LRD42AP con seduta, cornice **Alcova** in essenza rovere fumè ante laccato lucido biscotto 09 con attrezzatura interna. pomoli appendiabiti, ripiani portascarpe o ripiani e sistema di purificazione aria. Cuscino tessuto JAM DIS.2 C57.

Elemento **Stand** STP31 con specchio e vano a giorno folding in rovere fumè.

**Alcova** LRD42AP with seat cushion. **Alcova** frame in rovere fumé wood, doors in biscotto 09 glossy lacquered with internal equipment: coat hanger knobs, shelves or shoes rack shelves and air cleaner system. Seat cushion in JAM DIS.2 C57 fabric.

**Stand** STP31 end element with mirror and folding open box in rovere fumé.



Armadio con ante battenti laccato lucido biscotto 09, maniglia **Track**, laccato biscotto 09. Madia **Keen** struttura laccato opaco biscotto 09 frontali vetro laccato biscotto 09, interni nobilitato pelle antracite, interni cassetti nobilitato antracite, gola e piedi neri.

*Wardrobe with hinged doors in biscotto 09 glossy lacquered. **Track** handles in biscotto 09 lacquered. **Keen** sideboard, structure in biscotto 09 matt lacquered. Fronts in biscotto 09 lacquered glass, inner parts and drawers in pelle antracite melamine, black slot and feet.*

**KEEN SYSTEM**

La madia moderna **Keen** KEL63 si abbina con disinvoltura ad arredamenti di stile sia classico che moderno grazie al suo design minimal. Perfetta fusione tra contenuto e contenitore, grazie alla sua duttilità e alla personalizzazione delle superfici disponibili in legno impiallacciato, laccato e nobilitato ha inoltre

la possibilità di essere personalizzata con tutte le finiture disponibili nella collezione **Vetro Tumidei**. Finiture Madia **Keen**: frontali in essenza olmo termotrattato, fianchi e top laccato opaco nero 20 interni nobilitato pelle antracite, interno cassetti nobilitato antracite gola e piedi neri.

*The modern **Keen** KEL63 sideboard effortlessly matches with both classic and modern style furnishings thanks to its minimal design. Perfect fusion between content and container, thanks to its eclecticism and to the various surfaces customization in veneer, lacquered and melamine. It can also be customized*

*by using **Vetro Tumidei** collection available finishes. **Keen** sideboard finishes in olmo termotrattato wood, sides and top in nero 20 matt lacquered Inner parts and drawers in pelle antracite melamine. Black slot and feet.*





Armadio battente struttura  
noce nobilitato con frontali  
laccato opaco e vetro  
laccato muschio 46  
Window studio e nicchie  
con mensole sporgenti  
in noce nobilitato  
maniglia push-pull

*Hinged wardrobe with  
structure in noce melamine  
Fronts in muschio  
46 matt lacquered and  
lacquered glass  
Window studio and niches  
with overhanging shelves  
in noce melamine*

VETRO®



Armadio con ante battenti laccate opaco corda 65 e ante vetro con stampa digitale marmo WD MAR 003. Finitura interno armadio trama tessuto con cassetiera struttura laccato corda 65 e frontali vetro con stampa digitale WD MAR 003 e ripiani vetro extrachiaro.

*Wardrobe with hinged doors in corda 65 matt lacquered and glass doors with WD MAR 003 digital print. Internal structure in trama tessuto melamine. Chest of drawers in corda 65 lacquered and glass front parts with WD MAR 003 digital print.*



Letto **Plan** con testata e sommier legno laccato corda 65 con piede metallo nero, modulo laterale sinistro liscio e modulo laterale destro con nicchia e ripiano legno laccato corda 65, schiena nicchia con stampa digitale WD MAR 003. Luci opzionali per testata e elementi laterali. Tavolini **Stick** alto e intermedio metallo nero e vetro corda 65 **Pill** pouf medio in tessuto KIR 7806-05.

**Plan** bed with wooden headboard and sommier in corda 65 lacquered with black metal feet. Left plain module and right module with niche and wooden shelf in corda 65 lacquered. Niche back with WD MAR 003 digital print. Optional led for headboard and lateral modules. High and intermediate **Stick** coffee-table with black metal structure and 65 corda lacquered glass top. **Pill** medium pouf in KIR 7806-05 fabric.

**VETRO®**





SOLUTION A

Ante armadio nobilitato olmo bio  
e ante vetro con stampa digitale WD GRAN 002  
interni trama tessuto, fianchi terminali  
nobilitato olmo bio

*Wardrobe doors in olmo bio melamine  
and glass doors with WD GRAN 002 digital print  
internal structure in trama tessuto  
end sides in olmo bio melamine*

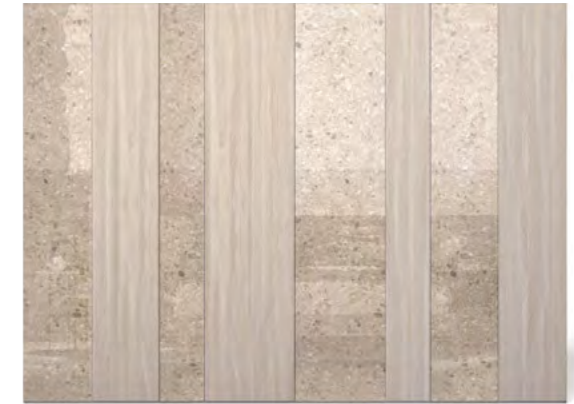

SOLUTION B

Ante armadio nobilitato limo 76  
e ante vetro laccato color limo 76  
interni trama tessuto  
fianchi esterni a vista laccato limo 76

*Wardrobe doors in limo melamine  
and glass doors limo 76  
internal structure in trama tessuto  
external sides in limo 76 lacquered.*



SOLUTION C

Ante armadio essenza rovere carbone  
e ante vetro laccato colore nero 20  
interni nobilitato pelle antracite  
fianchi esterni a vista essenza rovere carbone

*Wardrobe doors in rovere carbone wood  
and glass doors in nero 20 lacquered  
internal structure in pelle antracite melamine  
end sides in rovere carbone wood*





#### PLAN BED

Modulo laterale con nicchia e ripiano laccato opaco corda 65 in legno sp 1.2 oppure ripiano vetro extrachiaro spessore 1,2 cm con optional luce led su ripiano e presa Schuko e due usb con cavo di alimentazione posizionata sul lato nicchia.

*Lateral module with niche and matt lacquered shelf in corda 65 th. 1,2 cm or extra clear glass shelf th 1,2 cm with optional led light on shelf, Shuko outlet and two USB plugs.*



**PLAN** BED

Grazie alla sua componibilità, il sistema letto **Plan**, risolve con uno stile originale una molteplicità di situazioni, in ambiti contract o domestici. Il giroletto può essere imbottito o in legno, anche con piede centrale in metallo che insieme all'illuminazione

a Led, inserita nelle mensole in vetro, crea una sensazione di magica leggerezza. È caratterizzato da una rigorosa geometria che si coniuga perfettamente con la funzionalità ed eleganza dei suoi elementi laterali in nicchia.

*Thanks to its modularity, the **Plan** bed system can solve a variety of situations with original style, both in contract or domestic settings. The bed frame wooden or upholstered. It is also possible to add a metal foot below the center of the bed frame which,*

*together with the LED lighting installed behind the glass shelves, infuses a feeling of magical lightness. It's characterized by a rigorous geometry which perfectly combines with the functionality and elegance of its side niche items.*





Armadio con ante battenti in  
essenza olmo termotrattato,  
maniglie **Code** in vetro  
con stampa digitale legno  
WD LEGN E3.  
Interno armadio in  
nobilitato pelle antracite.

*Wardrobe with  
hinged doors in olmo  
termotrattato wood,  
**Code** handles with glass  
and WD LEGN E3 digital  
print. Wardrobe internal  
structure in pelle antracite  
melamine.*



Le maniglie **Code** sono un sistema funzionale e versatile. Si sviluppano su tutto il profilo verticale dell'anta dell'armadio, creando un gioco di pieni e vuoti che dà carattere al sistema armadio.

**Code** handles are a functional and versatile system. The set of **Code** handles expands throughout all the vertical profile of the wardrobe door, creating a trick of fullness and emptiness, which gives personality to the whole wardrobe system.

**VETRO**<sup>®</sup>





#### SOLUTION A

Ante e fianchi armadio nobilitato olmo grigio  
maniglie **Code** vetro laccato color lavagna 50  
interni olmo grigio

*Wardrobe doors and sides in olmo grigio melamine  
**Code** handles with lavagna 50 lacquered glass  
internal structure in olmo grigio melamine*



#### SOLUTION B

Ante e fianchi armadio laccato corda 65  
maniglie **Code** vetro con stampa digitale tessuto WD 368-02  
interni trama tessuto

*Wardrobe doors and sides in corda 65 lacquered  
**Code** handles with glass and WD 368-02 fabric digital print  
internal structure in trama tessuto melamine*

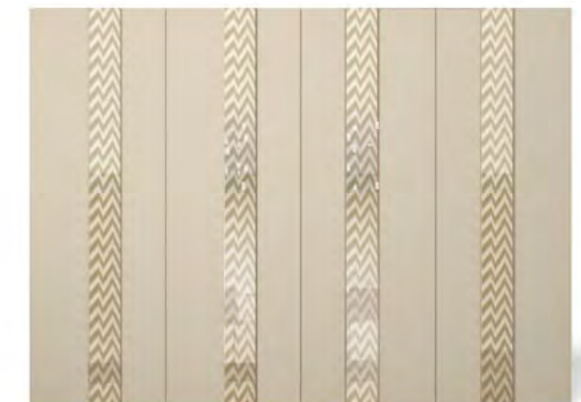

#### SOLUTION C

Ante e fianchi armadio essenza rovere fumè  
maniglie **Code** vetro specchiato bronzo  
interni nobilitato pelle antracite

*Wardrobe doors and sides in rovere fume wood  
**Code** handles with bronzed mirror  
internal structure in pelle antracite melamine*





Ante e fianchi esterni a vista laccato argilla 47, maniglie **Code** vetro specchiato, interni trama tessuto. Consolle con cassetti frontale vetro con stampa digitale tessuto WD

CON007 come tessuto del **Pill** pouf piccolo. Mensole **Line Up** (vedi listino ON-OFF) con vetro specchiato posizionate su pannello boiserie laccato argilla 47

Doors and external sides in argilla 47 lacquered, **Code** handles with mirror, internal structure in trama tessuto melamine. Console with glass front drawers with WD CON007

fabric digital print, matching with small **Pill** pouf. **Line Up** shelves (see ON-OFF pricelist) installed on a mirror and fixed onto a wall panel made in 47 argilla lacquered color.

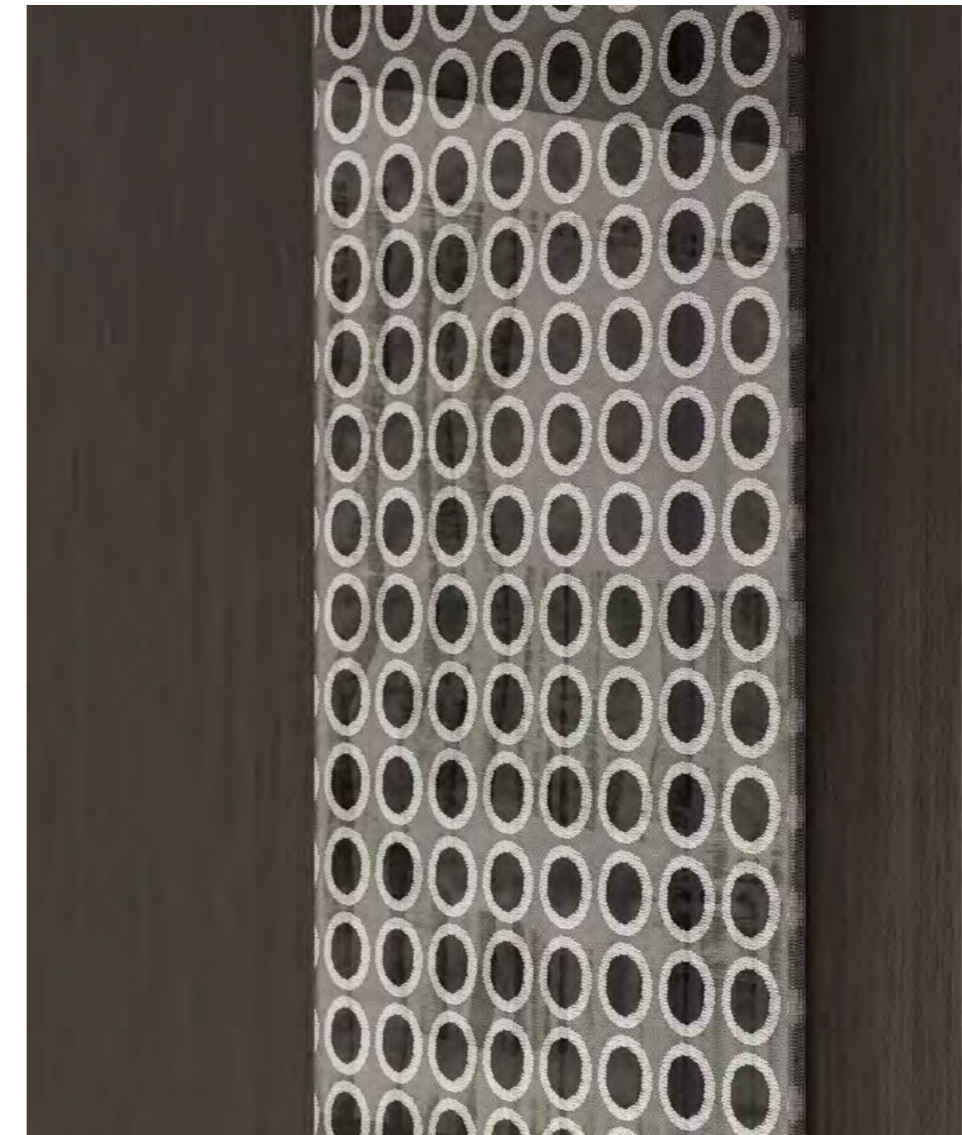

Ante e fianchi esterni  
a vista in essenza  
rovere carbone, interni  
nobilitato olmo grigio,  
maniglie **Code** in vetro  
specchiato grigio  
e vetro con stampa digitale,  
tessuto WD DER 7807-01,  
come tessuto letto **Tender**.

*Doors and external sides  
in rovere carbone wood,  
internal structure in olmo  
grigio melamine, **Code**  
handles with grey mirrored  
glass and glass with  
WD DER 7807-01 fabric  
digital print, matching  
with **Tender** bed fabric.*



Armadio battente, caratterizzato dalla maniglia **Code**, in vetro specchiato e con stampa digitale tessuto, lo stesso del letto **Tender**.

*Hinged wardrobe with **Code** handles, three made with mirrored glass and one having its glass digitally printed in order to match the fabric of the **Tender** bed.*

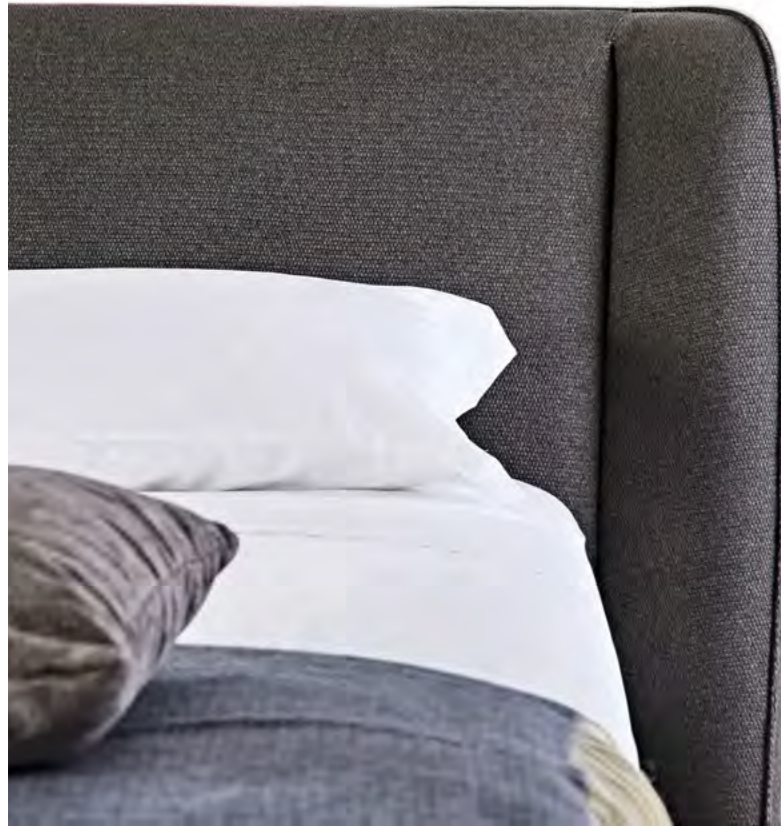

## TENDER BED

Letto **Tender** in tessuto DER 7807-01 interamente sfoderabile, a lato comodini **Circle** con cassetto e a vano vuoto.

*Tender bed in DER 7807-01 fabric, with fully removable covers, **Circle** night tables with drawer and open compartment.*



**TENDER BED**

Letto caratterizzato da un design avvolgente e da una testiera arrotondata, invitante da ogni punto di vista. Il morbido schienale rende la seduta eretta estremamente confortevole.

*Bed characterized by an enveloping design and a rounded headboard, tempting from every point of view. The soft backrest makes the upright seat extremely comfortable.*





Ante battenti in nobilitato olmo scuro, interni olmo scuro, con maniglia **Lowe** in alluminio ad incasso con vetro laccato color rame 85. La maniglia ad incasso **Lowe** può essere personalizzata con le laccature della gamma Tumidei, o in finitura vetro laccato e specchio, ed è possibile personalizzarle con stampe digitali Vetro permettendo l'abbinamento ai tessuti del campionario Tumidei.

*Hinged doors in olmo scuro melamine, internal structure in olmo scuro melamine, with embedded **Lowe** handle with rame lacquered glass. **Lowe** embedded handle can be customized with the wide range of Tumidei lacquered colours, or in lacquered glass and mirror finish, and can be customized with digital prints on glass allowing the combination with the fabrics of the Tumidei samples page.*

Letto **Plan** con testata laccato opaco color rame 85 e testata imbottita tessuto M 146-20. Sommier h 27 con piedi h 3 cm tessuto come testata, interamente sfoderabile.

**Plan** bed with rame 85 matt lacquered headboard and the upholstered part of the headboard made with fabric M 146-20. Its upholstered sommier is 27 cm high and it's equipped with 3 cm high feet. All the covers are fully removable.





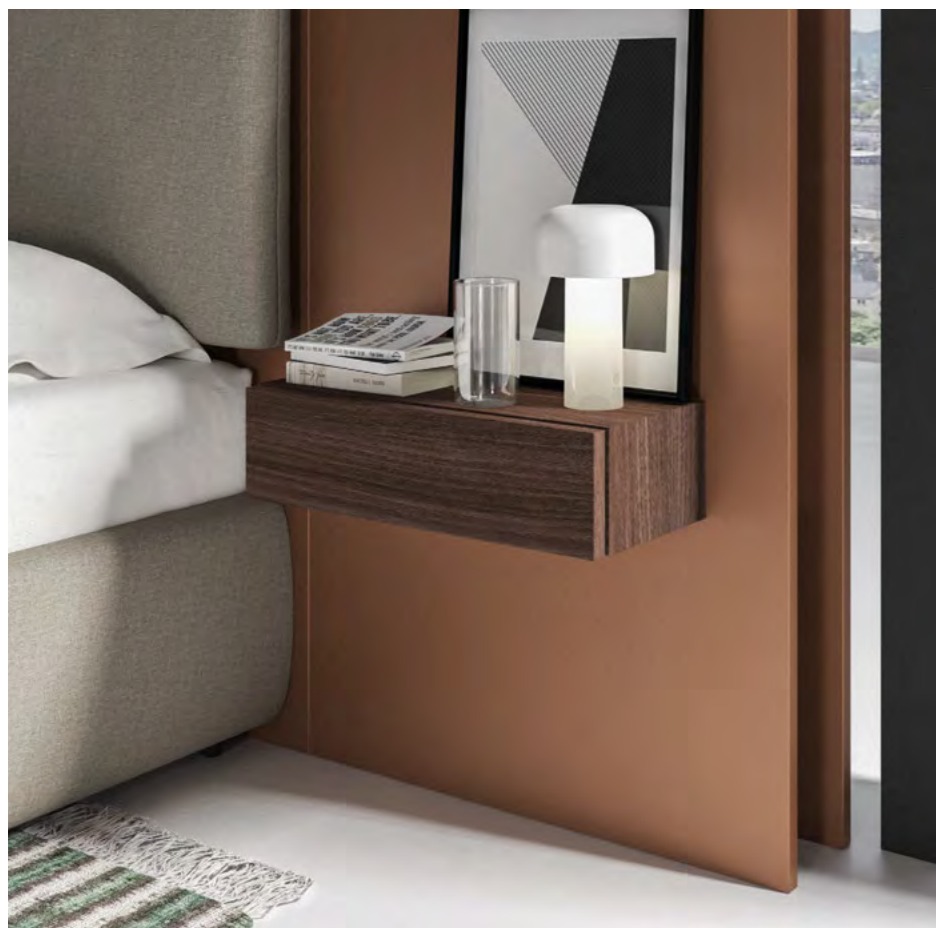

## MOOD BED

Modulo laterale destro liscio laccato rame 85 con cassetto in essenza rovere fumè, modulo laterale sinistro con nicchia laccato rame 85, ripiano vetro extrachiaro luminoso e schiena in vetro con stampa digitale legno essenza olmo scuro WD LEGN FF.

*The right-side plain module is made in rame 85 lacquered and equipped with a single drawer realized in rovere fumè wood.*

*The left-side module with niche is also made in rame 85 lacquered, embellished with an extra-clear glass shelf which is equipped with LED lighting. The back of the niche is made with the WD LEGN FF wooden effect digital print on glass.*





Ante e fianchi esterni a vista in Limo melamine, maniglia **Lowe** incassata con stampa digitale su vetro tessuto WD kir 7806-05. Interni olmo grigio. **Keen** KEL53 madia con 2 cassettoni e con cassetto interno opzionale, tutta laccata limo 76 gola e piedi neri.

*Doors and external sides in Limo melamine, embedded **Lowe** handle with glass and WD KIR 7806-05 fabric digital print, internal structure in olmo grigio melamine. Sideboard **Keen** KEL53 with 2 high drawers and optional internal drawers in limo 76 lacquered. Black slot and feet.*





Ante olmo grigio, maniglie **Arrow** in metallo laccate grafite 51, interni nobilitato pelle antracite.

*Doors in olmo grigio melamine, **Arrow** metal handles grafite 51 lacquered, internal structure in pelle antracite melamine.*





Cassettoni e comodini  
**Keen** laccato grafite 51  
piedi e gola neri.

***Keen** night tables and  
dressers in graphite 51  
lacquered.  
Black slot and feet.*



SOLUTION A

Ante e fianchi armadio nobilitato noce  
 maniglie **Arrow** laccate color rame 85  
 interni noce nobilitato

*Wardrobe doors and sides in noce melamine  
**Arrow** handles in rame 85 lacquered  
 Internal structure in noce melamine*

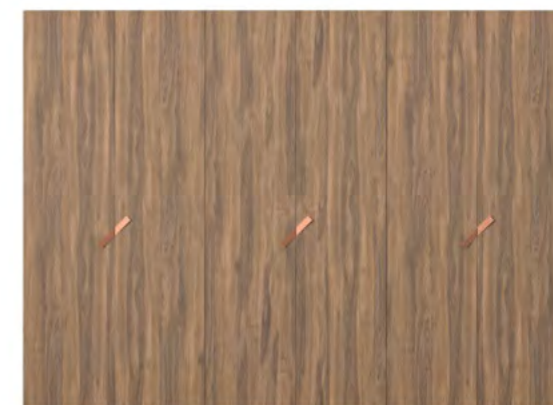

SOLUTION B

Ante e fianchi armadio laccato Tortora 78  
 maniglie **Arrow** laccate color caffè 29  
 interni nobilitato olmo scuro

*Wardrobe doors and sides in tortora 78 lacquered  
**Arrow** handles in caffè 29 lacquered  
 Internal structure in olmo scuro melamine*

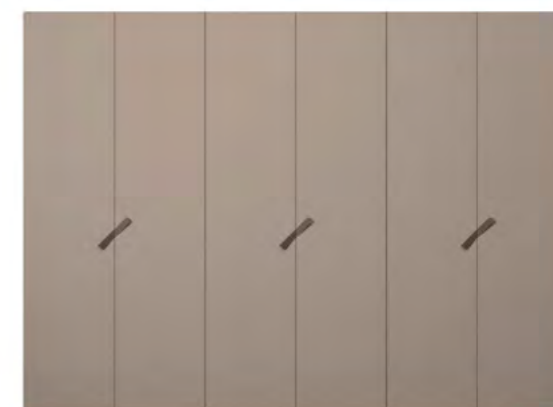

SOLUTION C

Ante e fianchi armadio essenza rovere naturale  
 maniglie **Arrow** laccate color limo 76  
 interni trama tessuto

*Wardrobe doors and sides in rovere natural wood  
**Arrow** handles in limo 76 lacquered  
 Internal structure in trama tessuto melamine*

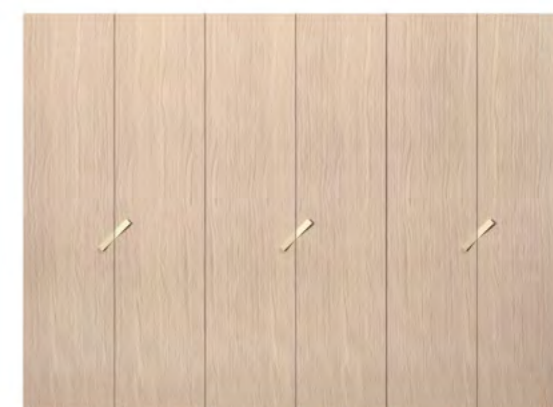



**COZY BED**

Letto **Cozy** in tessuto Surf 0074 giroletto e testata sfoderabile escluso i cuscini.

*Cozy bed made with Surf 0074 fabric. Bedstead and headboard fabrics are fully removable, except the cushions.*

**COZY BED**

Letto **Cozy** con testata realizzata in schiumato ad iniezione. Il meccanismo di scorrimento dei cuscini della testata è composto da una slitta che ne permette il movimento adattandosi all'altezza del materasso, sono caratterizzati da un alamaro centrale in pelle di colore nero bianco grigio oppure dello stesso tessuto utilizzato per il letto.

*Upholstered **Cozy** bed with injection foam headboard. The sliding mechanism of the headboard cushions is composed by sliding rails allowing to adjust them to the height of mattress. The main feature of these cushion is a central frog in leather, available in black, white or grey color, or in the same fabric used for the bed.*



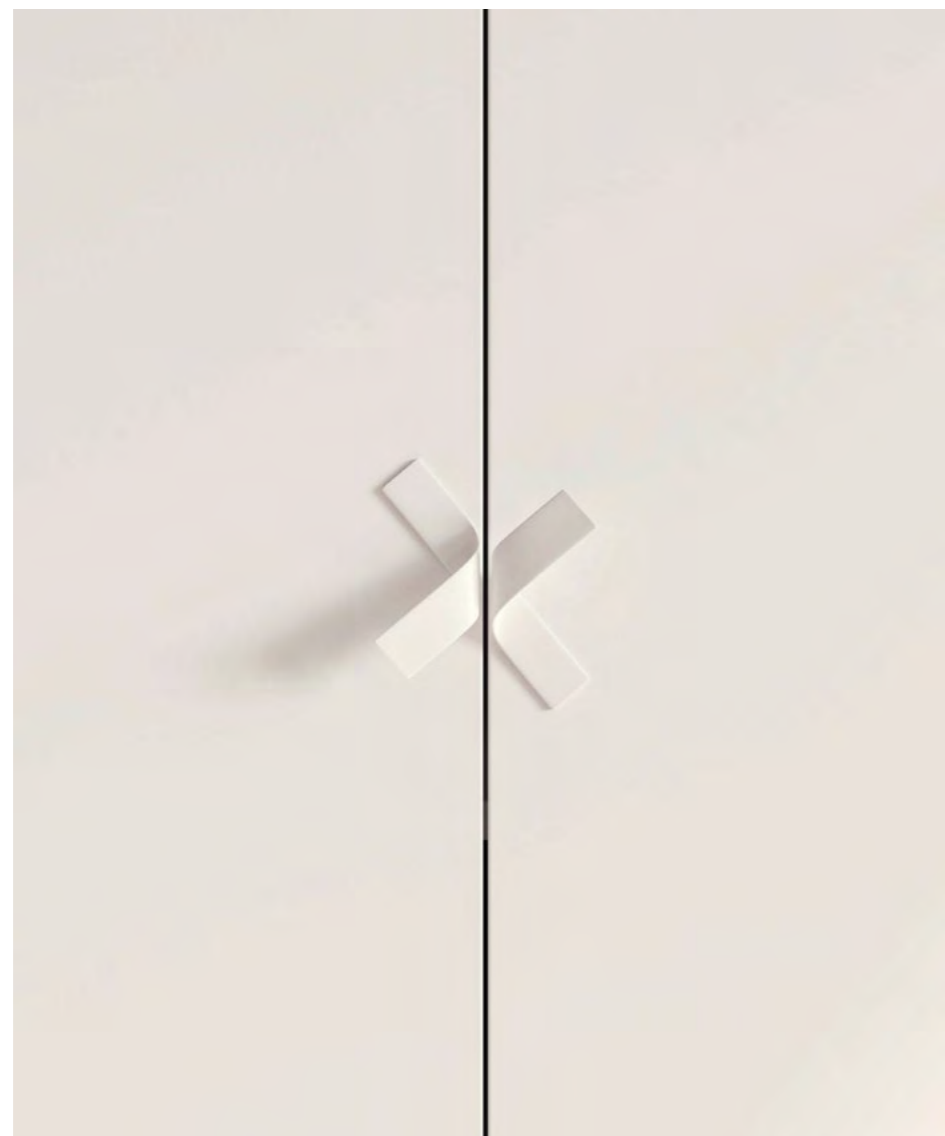

La maniglia **Fiocco** è il dettaglio che esprime al meglio, con un'icona forte ed essenziale, un linguaggio romantico e moderno. La maniglia **Fiocco** è un oggetto la cui identità suscita feeling ed empatia selezionando immediatamente la propria audience. Il fiocco è segno leggiadro e sorprendente, espressione di un dono o di un evento festoso. Top su cassettoni in vetro con stampa digitale tessuto WD 437-01

**Fiocco** handle is the detail, which best express a romantic and modern mood with a strong and essential icon. **Fiocco** handle is an object whose identity elicits feeling and empathy and immediately selects its own audience. It is a graceful and surprising sign, the expression of a gift or a festive event. Top above drawer in glass with WD 437-01 fabric digital print







Ante e fianchi laccato  
bianco 39, maniglie  
**Fiocco** in metallo  
laccato bianco 39.

Doors and sides  
in bianco 39 lacquered,  
**Fiocco** handles in  
bianco 39 lacquered metal.

Ante laccato blu ombra 52, fianchi nobilitato noce, maniglia **Sail** laccata blu ombra 52. Letto **Tommy** in tessuto CAN 011.

**Pill** pouf medio in tessuto CAN 011 e piano nobilitato noce.

*Doors in blu ombra 52 lacquered, sides in noce melamine, **Sail** handle in blu ombra 52 lacquered.*

**Tommy** bed in fabric CAN 011.

**Pill** medium pouf in fabric CAN 011 and top in noce melamine.





Armadio con taglio mansardato in nobilitato olmo calce, maniglia **Side** laccata bianca, interni nobilitato ghiaccio. Cabina **Mati** con pannello con stampa digitale righe bianco e nero tessuto WD erba 0022 con cassettera, raster e ripiani laccato nero 20.

Wardrobe with mandard cut in olmo calce melamine, **Side** handle in bianco lacquered, internal structure in ghiaccio melamine. **Mati** walk-in-closet with panel with WD erba 0022 fabric digital print with chest of drawers raster and shelves in nero 20 lacquered.

Elemento terminale smussato con anta e elemento pensile sopraporta in nobilitato olmo calce.

*Slanted end unit with door and overdoor wall unit in olmo calce melamine.*





Ante battenti e fianchi nobilitato Tortora, interni nobilitato olmo scuro con maniglia incassata **Track** laccato caffè.  
Moduli battenti h 261 cm e in sovrapposizione moduli h 96 cm che permettono alternanza pieno-vuoto tra maniglie **Track**.

*Hinged doors and sides in Tortora melamine  
Internal structure in olmo scuro melamine.  
With embedded **Track** handle in lacquered caffè.  
Hinged columns h 261 cm and overlapping units h 96 cm that allows full-empty alternation between **Track** handles.*



Modulo porta tv con anta battente apribile affiancato a modulo con mensole sp.2cm e divisori verticali sp.1.2cm in essenza rovere naturale. Maniglia incassata **Track** laccata opaco come ante battenti laccato lucido biscotto 09.

*TV panel with openable hinged door placed next to module with shelves th.2 cm and vertical partitions th. 1,2 cm in rovere natural wood. Embedded **Track** handle matching with hinged door placed next to in biscotto 09 glossy lacquered.*



Armadio con anta battente, nicchia con vano porta TV. L'anta porta TV è composta da un pannello, attrezzato con meccanismo orientabile che consente il posizionamento dello schermo per una visione ottimale. Composizione pensata per la sua ecletticità, adatta in zona giorno e notte.

*Wardrobe with hinged door and niche with TV panel. The TV door is composed by a panel, equipped with an adjustable mechanism, allowing the positioning of the screen for optimal viewing. This configuration has been conceived for its versatility, ideal for living and sleeping areas.*

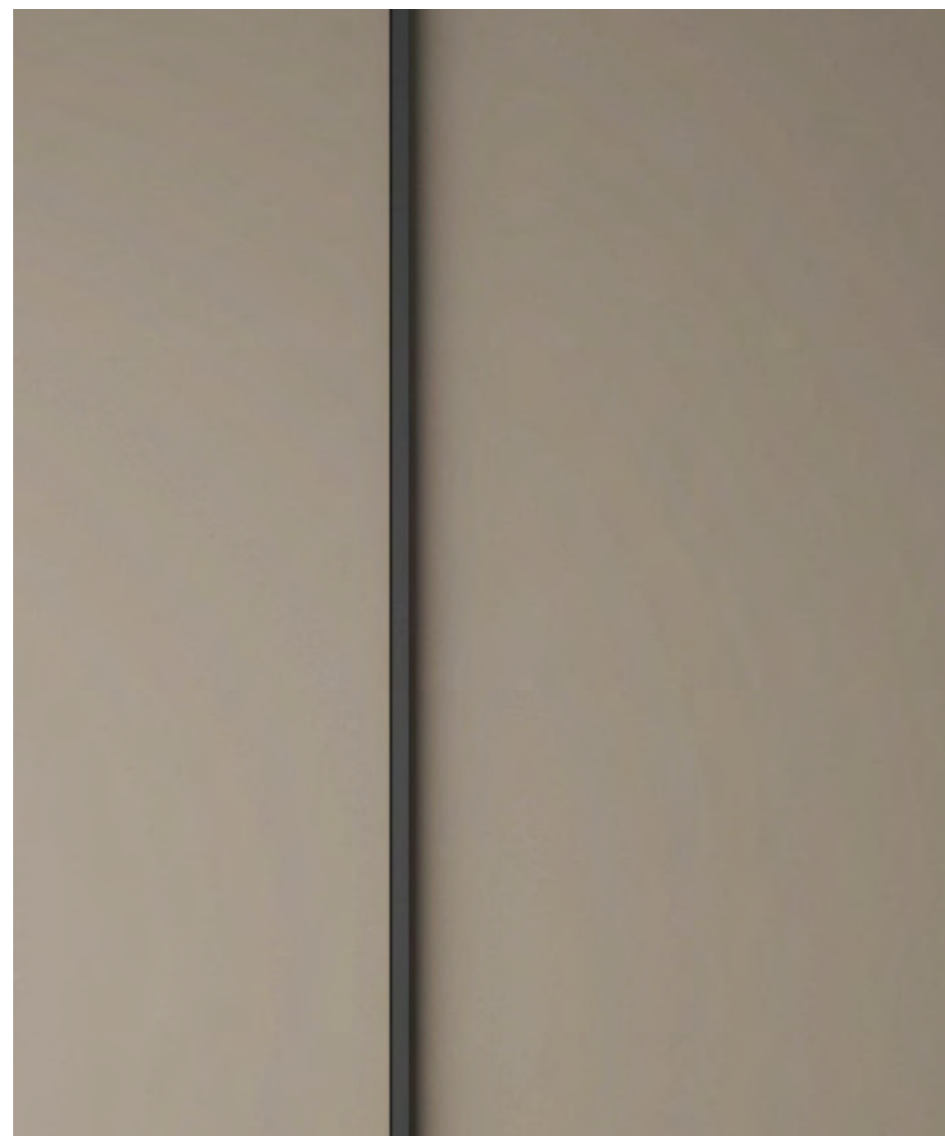

Nella pagina accanto:  
Elemento terminale  
**Magic Mirror** con  
specchio girevole  
predisposto internamente  
per portascarpe o  
pomoli appendiabiti,  
laccato tortora78, interno  
nobilitato olmo grigio.  
In dettaglio maniglia **Line**,  
un profilato discreto e  
molto pratico nell'utilizzo,  
si caratterizza per la  
sua pulizia e semplicità,  
disponibile in tutte le  
colorazioni del catalogo  
Tumidei.

In the next page:  
**Magic Mirror** end  
element with swivel mirror,  
internally equipped with  
rack for shoes or coat  
hanger hooks, external  
structure in tortora 78  
lacquered, internal  
structure in olmo grigio  
melamine.  
**Line** handle in nero 20  
laquered metal in detail,  
showing a discrete and  
practical profile.  
It is characterized by its  
simplicity, available in all  
the colours of the Tumidei  
catalogue.





Ante battenti in laccato tortora 78, maniglia **Line** laccata nero 20, ante vetro fumé con stampa digitale riga orizzontale nera con telaio in alluminio nero, interni olmo grigio. Credenza **Circle** CRL10P con fianchi e frontali in essenza olmo termotrattato, top superiore, inferiore e piedi **Classic** laccato nero 20.

*Hinged doors in tortora 78 lacquered, **Line** handle in nero 20 lacquered, smoked glass doors with horizontal stripes digital print and black aluminium frame. Internal structure in olmo grigio melamine. **Circle** CRL10P sideboard with sides and fronts in olmo termotrattato wood, upper and lower top and **Classic** feet in nero 20 lacquered.*



**CIRCLE SYSTEM**

Il modernismo avvolgente dei dettagli anni 50 incontra l'artigianalità moderna, **Circle** CRL01PS unisce la robustezza dell'ebanisteria industriale a dettagli eleganti e finiture esclusive, in una costruzione robusta e visivamente leggera al tempo stesso. Credenza **Circle** con fianchi e frontali in laccato argilla 47, top superiore, inferiore in essenza rovere fumè e piedi **Minimal** metallo nero.

*The embracing modernism expressed in the details of the 50's meets modern craftsmanship. **Circle** CRL01PS combines the robustness of industrial cabinet making with elegant details and exclusive finishes, in a construction which is at the same time sturdy while remaining visually light. Construction at the same time. **Circle** sideboard with sides and fronts in argilla 47 lacquered, upper and lower top in rovere fumè wood and black metal **Minimal** feet.*





ARMADI  
WARDROBES  
2020

CABINA ARMADIO  
WALK-IN-CLOSET  
/

Capiente, funzionale e componibile, le cabine armadio Tumidei possono essere attrezzate con moduli angolari, luci led retro ripiani, cassetti in vetro fumé, tubi appendiabiti e una vasta gamma di accessori. Il sistema a cremagliera, eliminando i fianchi di sostegno, risulta visivamente molto leggero.

*Spacious, functional and modular, the Tumidei closets can be equipped with corner units, led lights behind shelves, smoked glass drawers, hanging rails and a large variety of accessories. The rack system, with no end sides, looks visually light.*



Cabina **Ludo** senza pannelli boiserie, mensole, cassettiere con gola in laccato bianco 39. Coppia di settimini **Circle** tutto laccato bianco 39 con piedi **Minimal** laccato bianco versione possibile anche con piedi **Classic** o livellatori.

***Ludo** walk-in-closet with no panels, shelves, chest of drawers in bianco 39 lacquered.*

*Couple of **Circle** septet in bianco 39 lacquered with **Minimal** feet.*

*Also possible to make it with **Classic** feet or level adjusters.*



Carta da parati con stampa digitale graniglia WD GRAN 02  
Cremagliere, staffe e tubi appendiabiti alluminio bronzo della cabina **Ludo**.

Wallpaper with WD GRAN 02 digital print  
**Ludo** racks, supports and hanging rails in bronzed aluminium.





Cabina **Mati** con pannelli in nobilitato olmo grigio e specchio. Ripiani, portapantaloni e raster laccati grigio grafite 51, staffe, cremagliere e tubi appendiabiti alluminio bronzo. Luci led inseribili anche Wireless.

**Mati** Walk-in-closet with panels in olmo grigio melamine and mirror and printed glass. Shelves, trousers rack and raster in lacquered graphite 51. Supports, racks and hanging rail in bronzed aluminium. Optional led lights, available in wireless version too.



Armadio composto da un modulo battente con stampa digitale WD329 su fianco e ante push-pull, riportata anche su carta parati. Affiancato a un modulo battente con ante laccato grigio, grafite 51 con maniglia **Code** vetro con stampa digitale WD329.

*Wardrobe composed by one hinged door unit with WD329 digital print on doors and side matching with wallpaper. This one placed next to a hinged door unit with push-pull handles, with door in grafite 51 lacquered and **Code** handle with WD329 digital print on glass.*



#### PLY BED

Il Letto **Ply** ha una testata curva, soffice, avvolgente caratterizzata sul lato da una piegatura del tessuto fermata da un alamaro nello stesso tessuto della testata oppure su richiesta può essere in pelle bianco, nero, grigio, blu o chocolate. Tessuto 437-05.

***Ply** bed with curved, cosy soft headboard characterized by folds of fabric on sides finished with a fabric frog matching with the headboard or, on demand, in leather finish, black, white, grey, blue or chocolate. Fabric 437-05*



**PLY BED**

Interamente sfoderabile, con contenitore h 17 cm dove è possibile inserire **Secret Box**, piedi neri **Minimal** su richiesta sono inseribili anche piedi **Classic** per agevolare abbinamento ai nuovi gruppi notte. Il letto **Ply** si può richiedere anche con contenitore h 27 cm.

***Ply** bed with fully removable covers, with h17 cm storage box where it is possible to insert **Secret box**. **Minimal** black feet, on demand **Classic** feet to better match with new sleeping area items. **Ply** bed can also be customized adding a 27 cm high storage box.*





Finiture nella  
pagina seguente.

*Finishes in the  
following page*

VETRO®



Cabina **Mati** in essenza rovere fumè, caratterizzata da pannelli in vetro specchiato e vetro con stampa digitale marmo nero WD MAR 002. Staffe, tubi appendiabiti, ripiani vetro e cremagliere nascoste in alluminio bronzo. Moduli con ripiani portascarpe con ante vetro fumè con telaio in alluminio nero, interni nobilitato pelle antracite.

**Mati** walk-in-closet in rovere fumè wood, characterized by panels in mirror and glass with WD MAR 002 marble digital print. Supports, hanging rails, shelves frame and concealed racks in bronzed aluminium. Unit with shoes rack shelves with smoked glass doors and black aluminium frame, internal structure in pelle antracite melamine.





Angolo toilette formato da pannello diviso in tre parti, legno e specchio. Ripiano estraibile con frontale in vetro e organizer. Mensole in vetro e alluminio bronzo, con luce led a richiesta, anche wireless.

**Pill** pouf piccolo con tessuto 437-05.

*Toilette corner made up of three panels with alternation of wood and mirror, pullout shelves with glass front and organizer, bronzed aluminium frames glass shelf with led light. Upon request a wireless system can also be installed to control the lighting switch. **Pill** small pouf in fabric 437-05.*

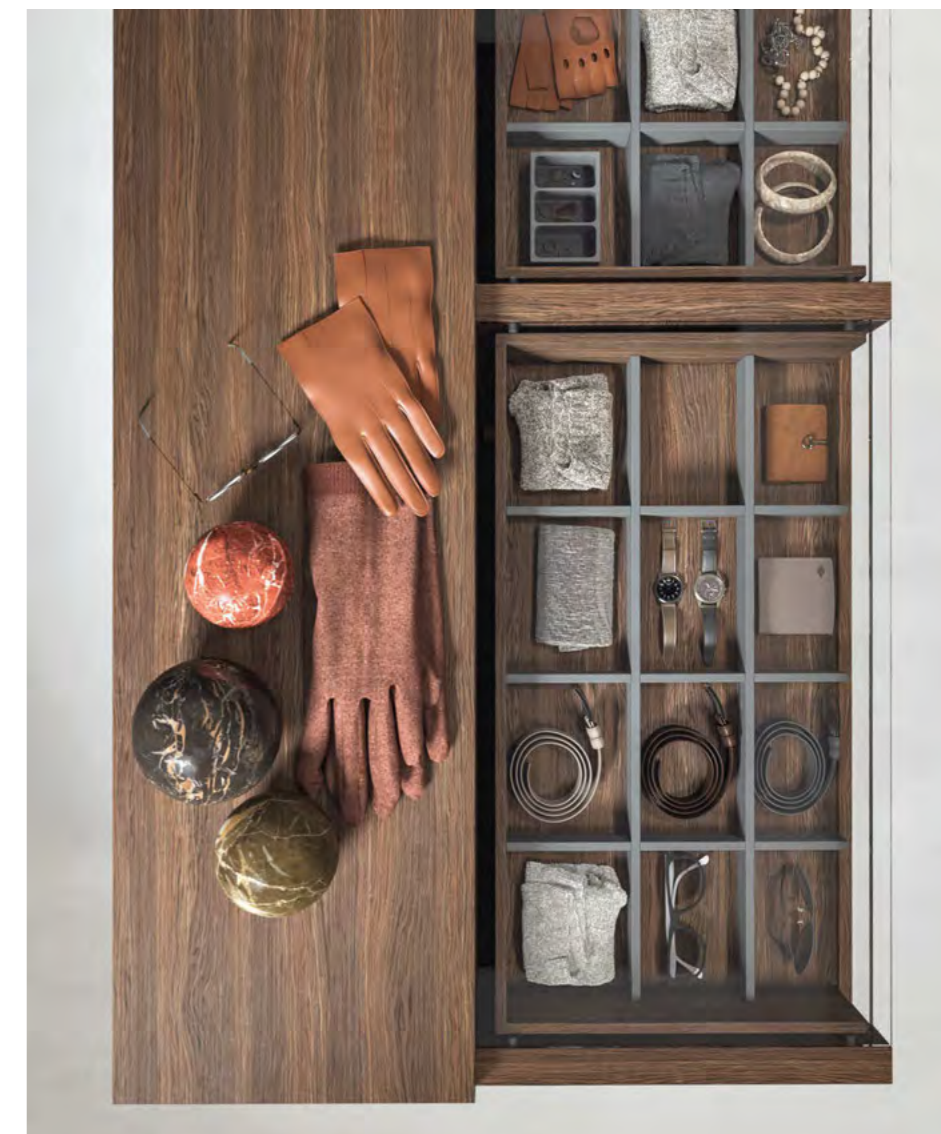

**Isola** bifacciale  
 caratterizzata da fianchi  
 sp.4 cm, da un lato cassetti  
 e ripiani estraibili in vetro  
 con organizer e top vetro  
 extrachiaro sp 1 cm,  
 dall'altro lato mensole  
 raster e top essenza rovere  
 fumè spessore 4 cm.

*Double-sided Isola*  
 characterized by th.  
 4 cm sides, one side with  
 drawers and glass pullout  
 shelves with organizer and  
 extraclear glas top th. 1 cm,  
 the other side with shelves,  
 raster and wooden top in  
 rovere fume th. 4 cm.



Moduli con ante battenti laccato ghiaccio 42 con maniglia alluminio incassata **Track** laccata colore grafite 51, affiancati da pannello **Mati** in nobilitato olmo bio, cremagliere bronzo con specchio, pomoli appendiabiti, pensile a ribalta, mensola, ed il tocco elegante dell'anta specchio che nasconde unicamente il vano appendiabiti.

*Wardrobes with hinged doors in ghiaccio 42 lacquered with aluminium. Embedded **Track** handle in grafite 51 lacquered. The wardrobe is placed next to a **Mati** closet with panel in olmo bio melamine, bronze racks with mirror, coat hanger knobs, tilt door wall box, shelves and the elegant touch of the mirror door covering.*



Maniglia incassata **Track** in alluminio laccata grafite 51 e disponibile in tutti i colori del campionario Tumidei.

*Embedded **Track** handle in grafite 51 lacquered aluminium, available in all Tumidei lacquered colours.*





Moduli **Open** con ripiani e fianchi p.2.5 cm in noce nobilitato, cassettiere sospese e raster laccati tortora 78, ripiani vetro extrachiario sp 1 cm, portapantaloni e tubi bronzo. Anta in luce specchio bronzo disponibile in diverse altezze e finiture.

**Open** units with shelves and sides th. 2,5 cm in noce melamine, hanging chest of drawers and raster in tortora 78 lacquered, extra-clear glass shelves th. 1 cm, trousers rack and bronze hanging rails. Inset door with bronze mirror available in different heights and finishes.





Moduli **Open** con fianchi sp. 2.5 cm, ripiani legno sp. 4cm, ripiani vetro sp. 1 cm e cassettiere sospese in nobilitato pelle antracite. Anta a specchio in luce a coprire solo una parte del modulo. Schiene con stampa digitale WD 368-01 abbinata al tessuto dei cuscini della panca **Keen** KEL43S.

**Open** units with sides th. 2.5 cm, wooden shelves th. 4 cm and glass shelves th. 1 cm, hanging chest of drawers in pelle antracite melamine. Inset mirror door covering part of the unit only. Backs with WD 368-01 digital print matching with the cushion fabric of the **Keen** KEL43S banquette.



Portapantaloni con frontalino in nobilitato pelle antracite, cassettoniera sospesa con cassettoni e ripiano estraibile con frontale vetro e top vetro. Luci led incassate nel fianco a tutta altezza.

*Trousers rack with front part in pelle antracite melamine, hanging chest of drawers with high drawer and pullout shelf with glass front and glass top. Total height led lights on sides.*

T

ARMADI  
WARDROBES  
2020

ANTA SCORREVOLE  
SLIDING DOOR  
/

Ottimizzando lo spazio a disposizione, gli armadi ad anta scorrevole rappresentano una soluzione d'arredo funzionale, capace di rispondere alle diverse esigenze progettuali.

*Optimizing the available space, the sliding wardrobes represent a functional furnishing solution, unable to meet different design requirements.*



Elemento porta TV laccato muschio 46 dotato di anta apribile predisposta con passaggio cavi, ripiani interni e consolle nella parte inferiore. Anta scorrevole laccato lucido lavagna 50 con maniglia **Line** in alluminio laccata lavagna 50.

*TV panel in muschio 46 lacquered with openable door set up for wires passage with internal shelves and console in the bottom part. Sliding door in Lavagna 50 glossy lacquered with aluminium **Line** handle in Lavagna 50 lacquered.*



Armadio scorrevole,  
dotato di chiusura  
rallentata ad azione  
magnetica.

Anta scorrevole  
liscia laccata lucida  
lavagna 50, maniglia

**Line** laccata lavagna 50,  
cassettiera e porta tv in  
laccato muschio 46.

*Sliding wardrobe equipped  
with magnetic action soft  
closing. Sliding doors  
in Lavagna 50 glossy  
lacquered, **Line** handle in  
lavagna 50 lacquered, chest  
of drawers and tv unit in  
Muschio 46 lacquered.*



Armadio scorrevole dotato di chiusura rallentata ad azione magnetica, ante scorrevoli in laccato blu ombra 52 e fasce orizzontali in vetro con stampa digitale WD KIR 7806-01, maniglia in alluminio **Line** laccata color blu ombra 52.  
**Pill** pouf medio tessuto KIR 7806-01, **Pill** pouf piccolo tessuto Aston 92.  
**Stick** tavolino metallo nero con piano vetro laccato blu ombra 52.

*Sliding wardrobe equipped with magnetic action soft closing. Sliding doors in blu ombra lacquered and horizontal strips in glass with WD KIR 7806-01 digital print, aluminium **Line** handle in blu ombra 52 lacquered. **Pill** medium pouf in KIR 7806-01 fabric **Pill** small pouf in Aston 92 fabric. **Stick** coffee-table with black metal structure and blu ombra 52 lacquered glass top.*



Dettaglio maniglia incassata **Track** in metallo con solo finitura laccato. Utilizzabile esclusivamente della stessa altezza dell'anta.

Nella pagina seguente, dettaglio anta scorrevole con fascia verticale in vetro specchiato grigio. La verticalità dell'elemento in vetro slancia l'anta conferendo eleganza e raffinatezza, disponibile nelle finiture vetro TUMIDEI. All'interno specchio con meccanismo scorrevole ed estraibile.

**Track** detail, embedded metal handle in lacquered finish only. To be used in the same height door only.

In the following page, a detail of the sliding door with vertical grey mirrored glass strip. Its verticality slims the whole wardrobe, making it elegant and sophisticated, available in all the Tumidei Vetro finishes. Inside the wardrobe, mirror with sliding and extractable mechanism.





Armadio scorrevole dotato di chiusura rallentata ad azione magnetica. Ante scorrevoli in nobilitato pelle antracite e fasce verticali in vetro specchiato grigio, maniglie incassate alluminio **Track** laccate grafite 51.

**Line up** mensole in metallo nero e schienale in vetro specchiato e vetro con stampa digitale WD DER 7807-04

Letto **Tender** tessuto AST053. **Pill** pouf piccolo in tessuto DER 7807-04.

**Stick** tavolino alto, piano vetro laccato grafite 51.

*Sliding wardrobe equipped with magnetic action soft closing.*

*Sliding doors in pelle antracite melamine and vertical strips in grey mirror. Embedded **Track** handles in grafite 51 lacquered aluminium.*

**Line Up** shelves in black metal and back panel in mirror and glass digital print WD DER7807-04

**Tender** Bed in AST053 fabric. **Pill** small pouf in DER 7807-04 fabric

**Stick** high coffee-table with glass top in grafite 51 lacquered.





#### SOLUTION A

Ante scorrevoli e fianchi in nobilitato bianco  
fasce verticali in vetro con stampa digitale WD 368 02  
maniglie incassate alluminio **Track** laccate bianco 39

*Sliding doors and sides in bianco melamine,  
vertical glass strips with WD 368-02 fabric digital print  
embedded **Track** handles in bianco 39 lacquered aluminium*



#### SOLUTION B

Ante scorrevoli e fianchi esterni a vista  
laccato corda 65, fasce verticali in vetro laccato corda 65  
maniglie incassate alluminio **Track** laccate corda 65

*Sliding doors and sides in corda 65 lacquered  
vertical strips in corda 65 lacquered glass, embedded  
**Track** handles in corda 65 lacquered aluminium*

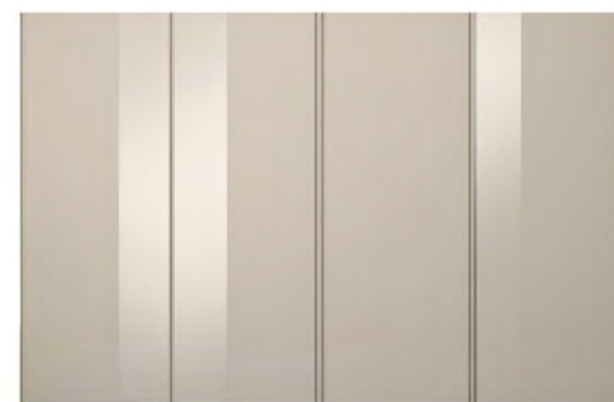

#### SOLUTION C

Ante scorrevoli e fianchi esterni a vista  
essenza rovere fumé, fasce verticali in vetro laccato avana 35  
maniglie incassate alluminio **Track** laccate avana 35

*Sliding doors and sides in rovere fume wood  
vertical strips in avana 35 lacquered glass, embedded  
**Track** handles in avana 35 lacquered aluminium*

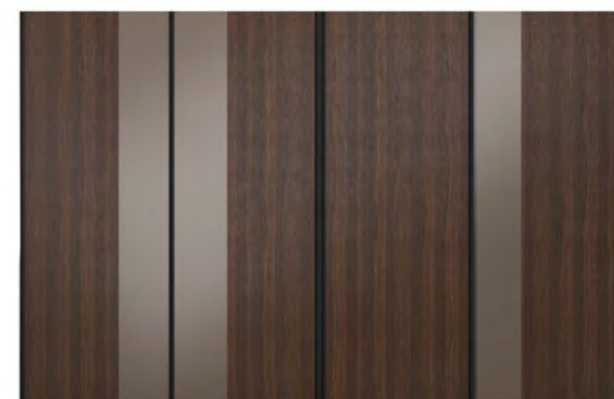



Armadio scorrevole, dotato di chiusura rallentata ad azione magnetica.  
Anta scorrevole liscia laccata cappuccino 41, maniglia **Track** laccata cappuccino 41, interni in olmo grigio, cassettera sospesa laccata cappuccino 41 con top in vetro extrachiario e ripiani vetro sp. 1 cm.  
Elemento terminale **Stand** STP11 per abiti con specchio.

*Sliding wardrobe equipped with magnetic action soft closing.  
Sliding doors in cappuccino 41 lacquered, **Track** handle in cappuccino 41 lacquered, internal structure in olmo grigio melamine, hanging chest of drawers in cappuccino 41 lacquered with glass top and glass shelves th. 1 cm.  
**Stand** STP11 end unit as hanger with mirror.*

Letto **Ply** in tessuto completamente sfoderabile testata e giroletto h 27 in tessuto Aston 92 con contenitore box apribile. Piedi **Obliqui** h 11 cm

***Ply** upholstered bed with fully removable cover. Headboard and h 27 bedframe in Aston 92 fabric with openable storage box **Obliqui** feet H.11 cm*





Armadio scorrevole dotato di chiusura rallentata ad azione magnetica. Anta scorrevole liscia laccata muschio 46 maniglia **Profile** laccata nero 20, interni in nobilitato olmo scuro. Cassettiera a 6 cassetti **Keen** KEL07 struttura nobilitato olmo scuro, frontali muschio 46, piedi neri. Comodino **Keen** KEL04 struttura nobilitato olmo scuro, frontali muschio 46, piedi neri.

*Sliding wardrobe equipped with magnetic action soft closing. Sliding doors in muschio 46 lacquered, **Profile** handle in nero 20 lacquered, internal structure in olmo scuro melamine.*

**Keen** dresser KEL07 with 6 drawers structure in olmo scuro melamine, front parts in muschio 46 lacquered, black feet **Keen** night table KEL04 structure in olmo scuro melamine, front parts in muschio 46 lacquered and black feet.





**CONTENUTI**

**CONTENTS**

<b>168</b>	<b>DETTAGLI STRUTTURA</b>	<b>STRUCTURE DETAILS</b>
<b>172</b>	<b>MODULI SPECIALI</b>	<b>SPECIAL MODULES</b>
	WINDOW	WINDOW
	COLONNE ELETTRODOMESTICI E SOPRAPORTA	APPLIANCE AND OVERDOOR COLUMNS
	ARMADI AD ANGOLO	CORNER CLOSETS
<b>178</b>	<b>ARMADI OPEN</b>	<b>OPEN WARDROBES</b>
<b>180</b>	<b>ARMADI ANTA BATTENTE</b>	<b>HINGED DOOR WARDROBES</b>
<b>184</b>	<b>ARMADI CRISTAL</b>	<b>CRISTAL WARDROBES</b>
<b>186</b>	<b>ARMADI ANTA SCORREVOLE</b>	<b>SLIDING DOOR WARDROBES</b>
<b>190</b>	<b>MANIGLIE</b>	<b>HANDLES</b>
<b>208</b>	<b>ATTREZZATURE INTERNE</b>	<b>INTERNAL EQUIPMENT</b>
	FINITURE	FINISHES
	ALLESTIMENTO INTERNO	INTERNAL ACCESSORIES
	RIPIANI E APPENDERIE	SHELVES AND HANGING RAILS
	CASSETTIERE E RASTER	CHEST OF DRAWERS & RASTERS
	ILLUMINAZIONE	LIGHTING
	ACCESSORI	ACCESSORIES
<b>238</b>	<b>CABINA ARMADIO MATI</b>	<b>MATI WALK-IN CLOSET</b>
<b>240</b>	<b>ISOLA</b>	<b>ISLAND</b>
<b>244</b>	<b>LETTI E COMPLEMENTI</b>	<b>BED AND ACCESSORIES</b>
<b>264</b>	<b>VETRO®</b>	<b>VETRO®</b>
<b>274</b>	<b>FINITURE</b>	<b>FINISHES</b>

Vi preghiamo di notare che le misure riportate nella parte in lingua inglese del catalogo sono espresse in inches. Pertanto, se desiderate verificare le dimensioni utilizzando il sistema metrico decimale dovrete far riferimento alle misure riportate nella parte in lingua italiana. Potrete facilmente reperirle come nell'esempio riportato di seguito:  
 Altezza di default  
 da 44 a 68 cm  
 Standard height from  
 17 21/64" to 26 49/64"

Kindly note that all the measures written in the English language part of the catalogue are displayed in inches. Therefore, if you wish to check the dimensions using the metric system you may refer to those written in the Italian part. You will easily find them as per below example:  
 Altezza di default:  
 da 44 a 68 cm.  
 Standard height from:  
 17 21/64" to 26 49/64"



**1 /** Magic mirror con portascarpe MM58.  
*Magic mirror with shoes racks MM58.*

**2 / 16 /** Colonna armadio 2 ante battenti B146.  
*Wardrobe column 2 hinged doors B146.*

**3 /** Colonna armadio con nicchie ed elementi pensili B200 - GV55N - PE56K.  
*Wardrobe column with niches and hanging units B200 - GV55N - PE56K.*

**4 / 20 /** Colonna armadio 1 ante battente B134.  
*Wardrobe column 1 hinged door B134.*

**5 /** Cabina armadio ad angolo tipo A con ante a soffietto GEA04N.  
*Corner column wardrobe type A with hinged doors GEA04N.*

**6 / 8 / 12 / 19 / 22 / 24 /** Colonna armadio 1 ante battente B141.  
*Wardrobe column 1 folding door B141.*

**7 /** Colonna tv con consolle, colonna armadio 3 cassetti 1 cassettone ed elemento pensile 2 ante battenti PT043.  
*Tv column with console column wardrobe 3 drawers 1 high drawer and wall unit with 2 hinged doors PT043.*

**9 /** Colonna armadio 1 ante vetro fumè B329.  
*Wardrobe column 1 smoked glass door B329.*

**10 /** Boiserie Spazio 15 con elemento pensile h 64 cm BE46 PE65KN.  
*Wall panels Spazio 15 with hanging unit h 25 13/64" with hanging unit h 25 13/64" BE46 PE65KN.*

**11 /** STAND con specchio e cassetiera con 4 cassetti STC22.  
*STAND with mirror and chest of drawers with 4 drawers STC22.*

**13 /** Colonna armadio 2 ante con vetro fumè B306.  
*Wardrobe column 2 smoked glass doors B306.*

**14 /** Cabina armadio ad angolo tipo D con ante battenti GEA12.  
*Corner column wardrobe type D with hinged doors GEA12.*

**15 /** Cabina armadio MATI con pedana, 1 specchio 1 ripiano estraibile con frontale in vetro e organizer, 4 ripiani in vetro con tubo appendiabiti.  
*MATI walk-in-closet with base, 1 mirror, 1 pull-out shelf with glass front part and organizer, 4 glass shelves with hanging rail.*

**17 /** Colonna armadio 2 ante e 1 vano a giorno con ripiano B243.  
*Wardrobe column 2 doors and 1 open block with shelf B243.*

**18 /** WINDOW SEDUTA con 2 ripiani 1 ante battente con colonna armadio 2 ante ed elementi pensili con 2 ante battenti.  
*WINDOW SEDUTA with 2 shelves 1 hinged door, 1 column wardrobe with 2 hinged doors and 2 hanging units with 2 hinged doors.*

**21 /** Cabina armadio lineare CARRY tipo 2 KCA34.  
*CARRY linear closet type 2 KCA34.*

**23 /** Boiserie con specchio, console studio ed elemento pensile con 2 ante battenti BE86 SVN13 MQ77 PE66K.  
*Wall panel with mirror, console studio and hanging unit with 2 hinged doors BE86 SVN13 MQ77 PE66K.*

**25 /** Elemento terminale con schiena e 6 mensole D140.  
*End unit with back and 6 shelves D140.*

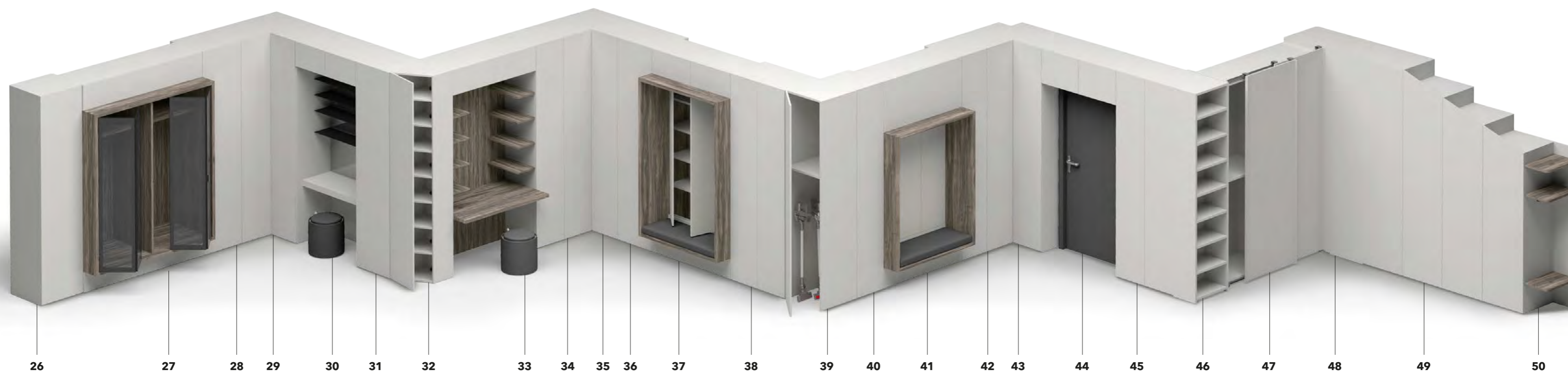

**26 / 28 / 31 / 36 / 40 / 42** Colonna armadio 1 anta battente B141. *Wardrobe column 1 hinged door B141.*

**27** / ALCOVA con 2 ante a soffietto in vetro, anta a ribalta superiore e inferiore (vedi listino ON-OFF). *ALCOVA with folding glass doors, upper and lower tilt doors (see ON-OFF pricelist).*

**29** / Colonna armadio ad angolo tipo D con ante battenti GEA12. *Corner closet type D with hinged doors GEA12.*

**30** / Boiserie Spazio 15 con specchio, ripiano folding, mensole in vetro LINE UP ed elemento pensile con anta a ribalta BE86 SVN13 PG39 ML63 PEW03K. *Wall panels Spazio 15 with mirror, folding shelf, LINE UP glass shelves and hanging unit with tilt door BE86 SVN13 PG39 ML63 PEW03K.*

**32** / Elemento terminale smussato D173. *Slanting end unit D173.*

**33** / WINDOW STUDIO con piano scrittoio, 8 mensole ed elemento pensile con anta a ribalta WN02. *WINDOW STUDIO with desk, 8 shelves and wall unit with tilt door WN02.*

**34** / Colonna armadio 1 anta battente B134. *Wardrobe column 1 hinged door B134.*

**35** / Colonna armadio ad angolo tipo D con ante battenti GEA12. *Corner column type D with hinged doors GEA12.*

**37** / ALCOVA ARMADIO con seduta, ante battenti, anta a ribalta superiore e inferiore LRE42R (vedi listino ON-OFF). *ALCOVA ARMADIO with seat, hinged doors, upper and lower tilt doors LRE42R (see ON-OFF price list).*

**38** / Colonna armadio 2 ante a soffietto B277. *Wardrobe column 2 folding doors B277.*

**39** / Colonna 1 anta senza base e senza schiena inferiore B708. *Column 1 door, without base and without lower back B708.*

**41** / ALCOVA ARMADIO con seduta 3 ante, anta a ribalta inferiore e superiore LRI41R PEA07 (vedi listino ON-OFF). *ALCOVA ARMADIO with seat, 3 doors, upper and lower tilt doors LRI41R PEA07 (see ON-OFF pricelist).*

**43** / Colonna armadio ad angolo tipo D con ante battenti e scasso pilastro GEA12. *Corner column type D with hinged doors and cut out for pillar GEA12.*

**44** / Pensile sopraporta con 2 ante battenti e fianchi di chiusura PE902. *Overdoor wall unit with 2 hinged doors and end sides PE902.*

**45** / Colonna armadio 2 ante battenti B146. *Wardrobe column 2 hinged doors B146.*

**46** / Elemento terminale libreria con 7 ripiani. *End bookcase with 7 shelves.*

**47** / Armadio 2 ante scorrevoli AR35. *Wardrobe 2 sliding doors AR35.*

**48** / Cabina armadio lineare CARRY tipo 2 KCA34. *CARRY linear closet type 2 KCA34.*

**49** / Set di 4 colonne armadio con tagli per mansarda su anta battente singola. *Set of 4 wardrobe columns with cuts for mansard on single hinged doors.*

**50** / Elemento terminale con schiena, 3 mensole e 2 ganci appendiabiti. *End unit with back, 3 shelves and 2 coat hanger hooks.*



88 - 117.6 - 132 - 146.8 - 176.4  
 34 41/64" - 46 19/64" - 51 31/32" - 57 51/64" - 69 29/64"

**WINDOW SEDUTA / NICCHIA**  
**WINDOW SEDUTA / NICCHIA**

Larghezza totale  
 88 - 117.6 - 132  
 146.8 - 176.4 cm

Altezza totale  
 229 - 261 - 293 cm

L'elemento WINDOW  
 SEDUTA/NICCHIA è  
 composto da:

colonne armadio h 37 cm  
 ed elemento pensile in  
 finitura interna nobilitato  
 per interni e finitura  
 esterna nobilitato, laccato,  
 essenza e stampa digitale.

Boiserie SPAZIO 15 in  
 finitura nobilitato, laccato  
 e essenza.

Cuscino seduta  
 altezza 7 cm

Su richiesta, mensole  
 spessore 2 cm in finitura  
 nobilitato, laccato e  
 essenza e anta singola  
 battente larghezza  
 29.1 cm, oppure tubi  
 appendiabiti.

Gli elementi WINDOW  
 SEDUTA/NICCHIA si  
 abbinano alle colonne  
 armadio battenti.

*Total width*  
 34 41/64" - 46 19/64"  
 51 31/32" - 57 51/64"  
 69 29/64"

*Total height*  
 90 5/32" - 102 3/4"  
 115 23/64"

*WINDOW SEDUTA  
 NICCHIA is composed by:*

*wardrobe columns  
 h 14 9/16" and hanging  
 unit with internal structure  
 in melamine for inner  
 parts only, external parts  
 in melamine, lacquered,  
 wood finish and digital  
 print.*

*SPAZIO 15 wall panel in  
 melamine, lacquered or  
 wood finishes.*

*Seat cushion heght 2 3/4",  
 On demand, shelves  
 25/32" thickness in  
 melamine lacquered  
 and wood finish,  
 single hinged door width  
 11 27/64" or hanging rails.*

*The WINDOW SEDUTA  
 NICCHIA items can be  
 combined to the hinged  
 door columns.*



117.6 - 132 - 176.4  
 46 19/64" - 51 31/32" - 69 29/64"

**WINDOW STUDIO**  
**WINDOW DESK**

Larghezza totale  
 117,6 - 132 - 176,4 cm

Altezza totale  
 229 - 261 - 293 cm

L'elemento WINDOW  
 STUDIO è composto da:

elemento pensile in  
 finitura interna nobilitato  
 per interni e finitura  
 esterna nobilitato, laccato,  
 essenza e stampa digitale.

Scrittoio spessore 4 cm  
 in finitura nobilitato.

Mensole spessore 2 cm  
 in finitura nobilitato,  
 laccato, essenza.

Boiserie SPAZIO 15 in  
 finitura nobilitato, laccato,  
 essenza e stampa digitale.

Gli elementi WINDOW  
 STUDIO si abbinano alle  
 colonne armadio battenti.

*Total width*  
 46 19/64" - 51 31/32"  
 69 29/64"

*Total height*  
 90 5/32" - 102 3/4"  
 115 23/64"

*WINDOW STUDIO is  
 composed by:*

*hanging unit with structure  
 in melamine finish for inner  
 parts, and external parts in  
 melamine, lacquered, wood  
 finish and digital print.*

*Desk 1 37/64" thickness in  
 melamine finish.*

*Shelves 25/32" thickness  
 in melamine, lacquered  
 and wood finish.*

*SPAZIO 15 wall panels in  
 melamine, lacquered, wood  
 finish and digital print.*

*The WINDOW STUDIO  
 items can be combined to  
 the hinged door columns.*





**COLONNE ELETTRODOMESTICI  
APPLIANCE COLUMNS**

Le colonne elettrodomestici possono essere composte da:

Colonne con profondità struttura 75 cm senza schiena inferiore e base e con fascia di irrigidimento altezza 8 cm in metallo

Colonne con profondità struttura 75 cm con base  
Larghezza standard  
56.4 - 85.6 - 115.2  
Altezza standard  
229 - 261 - 293

Colonne in finitura interna nobilitato per interni e finitura esterna nobilitato, laccato, essenza e stampa digitale.

Il divisore centrale della colonna può essere, su richiesta, in altezza di dimensioni diverse.

Le cerniere di default sono con apertura 165°  
Ingombro cerniere:  
6 cm per lato.

*Appliance columns can be composed by:*

*29 17/32" deep column without lower back and base, with h 3 5/32" metal stiffening strip.*

*29 17/32" structure deep column with base  
Standard width  
22 13/64", 33 45/64",  
45 23/64"  
Standard height 90 5/32"  
102 3/4" - 115 23/64"*

*Column finishes in melamine for inner parts only, external parts in melamine, lacquered, wood finish and digital print.*

*Column side partition can be with different height, on demand.*

*Hinges encumbrance 2 23/64" each side  
Standard hinges are 165° opening.*



**PENSILI SOPRAPORTA  
OVERDOOR WALL UNITS**

L'elemento sopraporta può variare in altezza e larghezza al centimetro.

Pensili in finitura interna nobilitato per interni e finitura esterna nobilitato, laccato, essenza e stampa digitale.

Larghezza standard da 117.6 a 132 cm (larghezza massima)

Altezza di default da 44 a 68 cm.

*Overdoor wall unit can have different height and width.*

*Wall unit finishes in melamine for inner parts only, external parts in melamine, lacquered, wood finish and digital print.*

*Standard width from 46 19/64" to 51 32/32" (maximum width)*

*Standard height from 17 21/64" to 26 49/64"*



**COLONNE AD ANGOLO  
CORNER COLUMNS**

Le cabine ad angolo sono composte da: fianchi bordati su 4 lati con foratura passo 16 cm e livellatori. Ante con cerniere a rientro rallentato o con meccanismo a soffietto. ripiani interni spessore 2,5 o 4 cm fissati a schiene e fianchi con supporti bloccanti.

*Corner columns are composed by: side panels edged on 4 sides and drilled with a 6 19/64" range, and levelers. Doors with soft-close hinges or with accordion folding mechanism. internal shelves 63/64" or 1 37/64" thick fixed to the back and sides with blocking brackets.*

La struttura in finitura nobilitato per interni, i frontali e i fianchi in finitura nobilitato, laccato lucido o opaco, essenza o con stampa digitale.

*Structure in melamine finish for inner parts, front panels and sides in melamine, matt or glossy lacquered, wood finish or with digital print.*

**N.B.**  
Cabina armadio TIPO A è disponibile anche con ante a soffietto.

**N.B.**  
Corner column TYPE A also available with folding doors.

**TIPOLOGIE DI COLONNE AD ANGOLO:  
CORNER CLOSET TYPE:**

CABINA ARMADIO TIPO A ALTEZZA DA 197 A 293 cm  
CORNER CLOSET TYPE A HEIGHT FROM 77 9/16" TO 115 23/64"

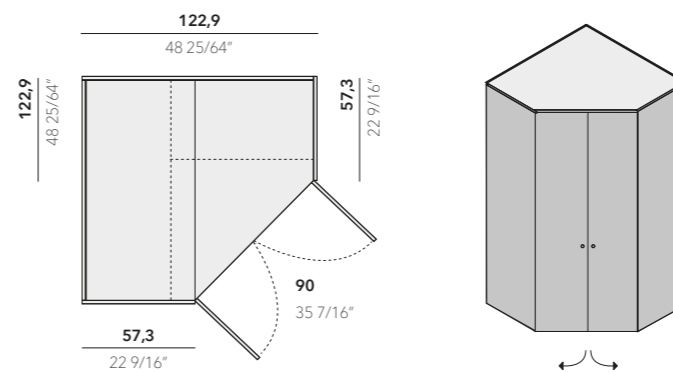

CABINA ARMADIO TIPO B ALTEZZA DA 197 A 293 cm  
CORNER CLOSET TYPE B HEIGHT FROM 77 9/16" TO 115 23/64"

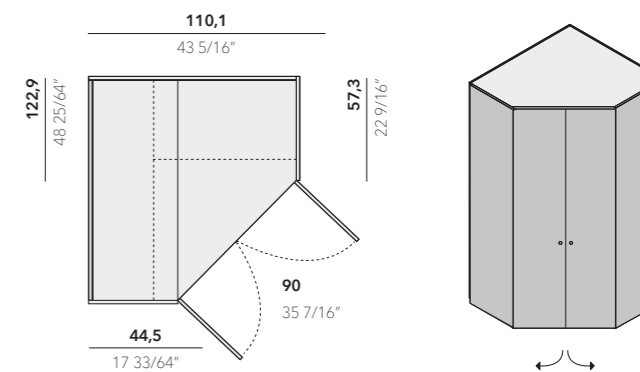

CABINA ARMADIO TIPO C ALTEZZA DA 197 A 293 cm  
CORNER CLOSET TYPE C HEIGHT FROM 77 9/16" TO 115 23/64"

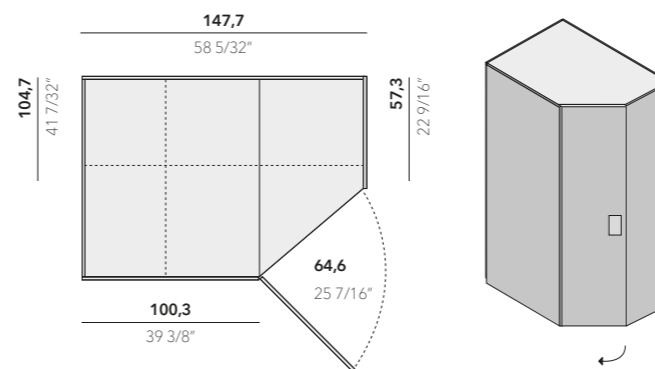

CABINA ARMADIO TIPO D ALTEZZA DA 197 A 293 cm  
CORNER CLOSET TYPE D HEIGHT FROM 77 9/16" TO 115 23/64"

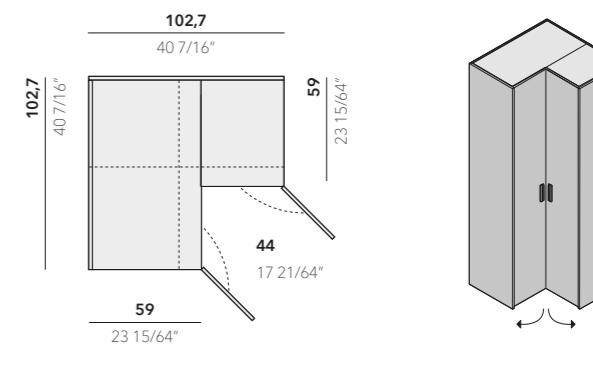

CABINA ARMADIO TIPO E ALTEZZA DA 197 A 293 cm  
CORNER CLOSET TYPE E HEIGHT FROM 77 9/16" TO 115 23/64"

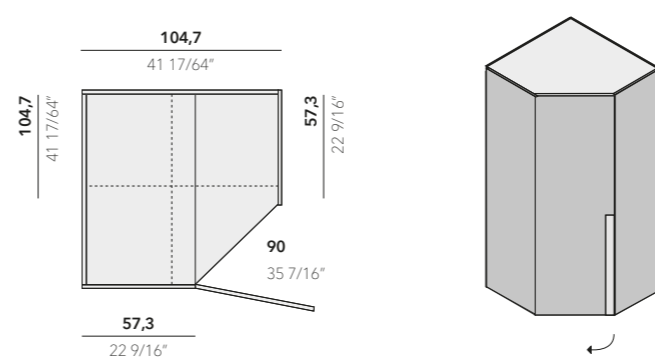

CABINA ARMADIO CARRY ALTEZZA DA 197 A 293 cm  
CARRY CLOSET CARRY HEIGHT FROM 77 9/16" TO 115 23/64"

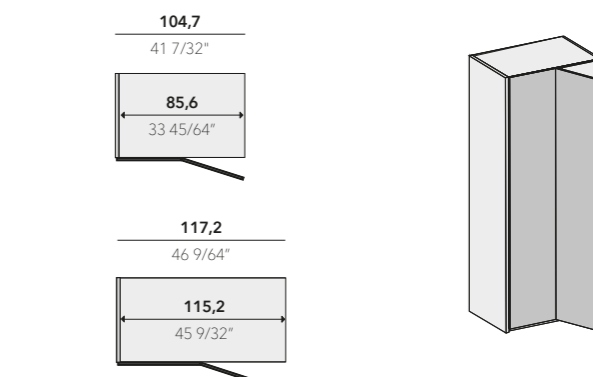

**ARMADI OPEN**  
MODULARITÀ CUT FREE  
**WARDROBE OPEN**  
CUT FREE MODULARITY

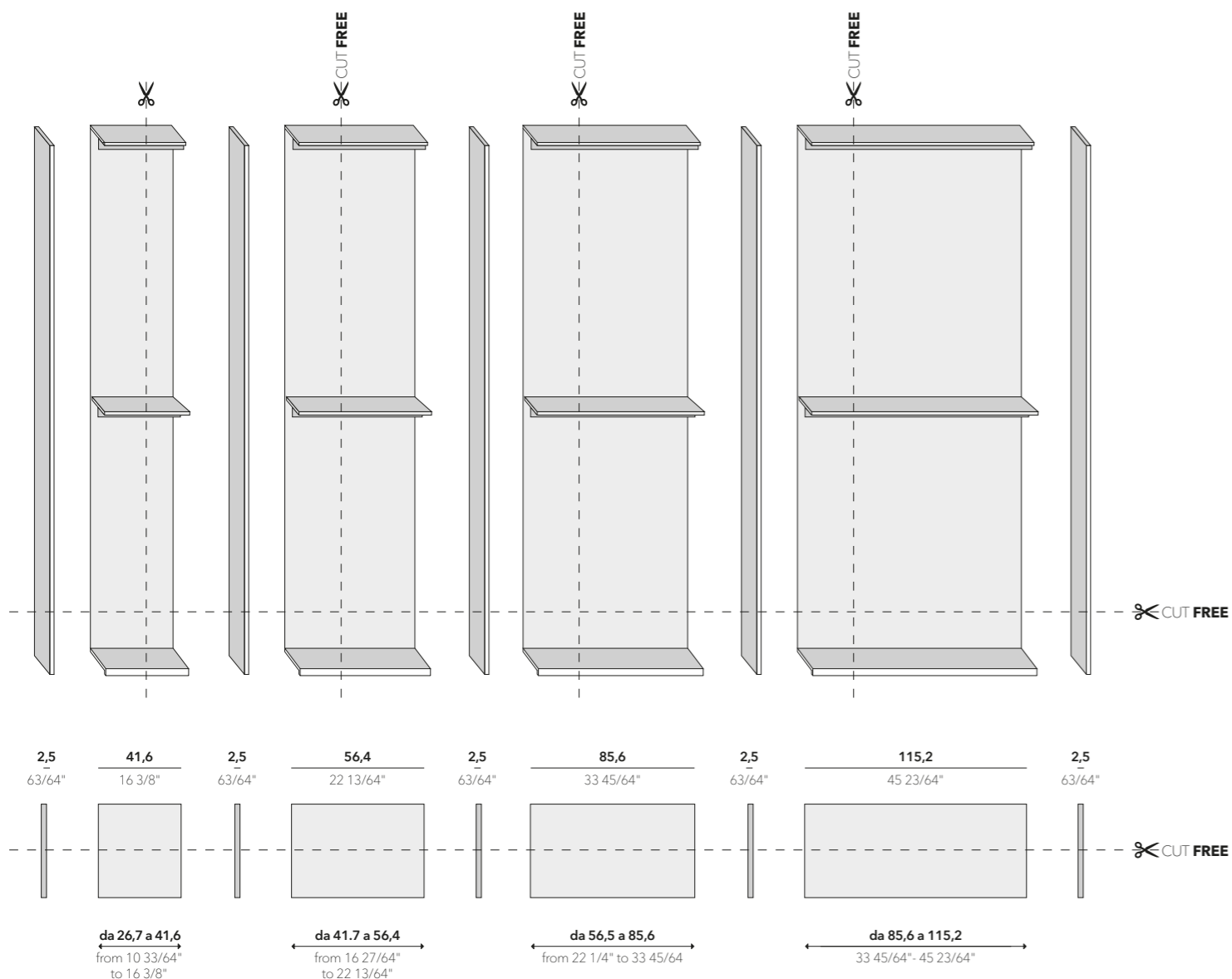

Profondità struttura da 18 a 102 cm  
Altezza struttura da 37 a 293 cm  
Structure depth from 7 3/32" to 40 5/32"  
Structure height from 14 9/16" to 115 23/64"

I moduli e i fianchi divisorii hanno finitura solo nobilitato per interni. Gli armadi OPEN possono essere allestiti internamente allo stesso modo degli armadi con anta battente, l'unica differenza riguarda i frontali: in sostituzione delle ante, possono essere inserite ante in luce di dimensioni ridotte, sia in larghezza, sia in altezza. Queste ultime possono essere in finitura nobilitata, laccato opaco e lucido, essenza opaca e lucida, con

stampa digitale oppure con vetro specchiato, retro-laccato o con stampa digitale.

**N.B. Nel modulo da 41.6 cm, base, cappello, ripiani e schiena subiscono maggiorazioni di taglio, anta esclusa.**

I fianchi sono forati con passo 16 cm e sono forniti di serie con punzonatura totale e premontaggio della ferramenta per basi, cappelli e frontali.

*The structure and sides are in melamine finish for inner parts only. OPEN wardrobes can be internally equipped in the same way as the wardrobes with hinged doors, the only difference concerns the fronts. Instead of doors, it is possible to insert flushed doors of reduced dimensions, both in width and height. These ones can be in melamine, lacquered or wood finish*

*or with applied glass or digital print.*

**N.B. In the column W 16 3/8", top, shelves and back panel are subjected to supplement for cut, doors excluded.**

*Sides are drilled with a 6 19/64" range. Standard sides are supplied with total punching and pre-assembly of the hardware for bases, tops, and front parts.*

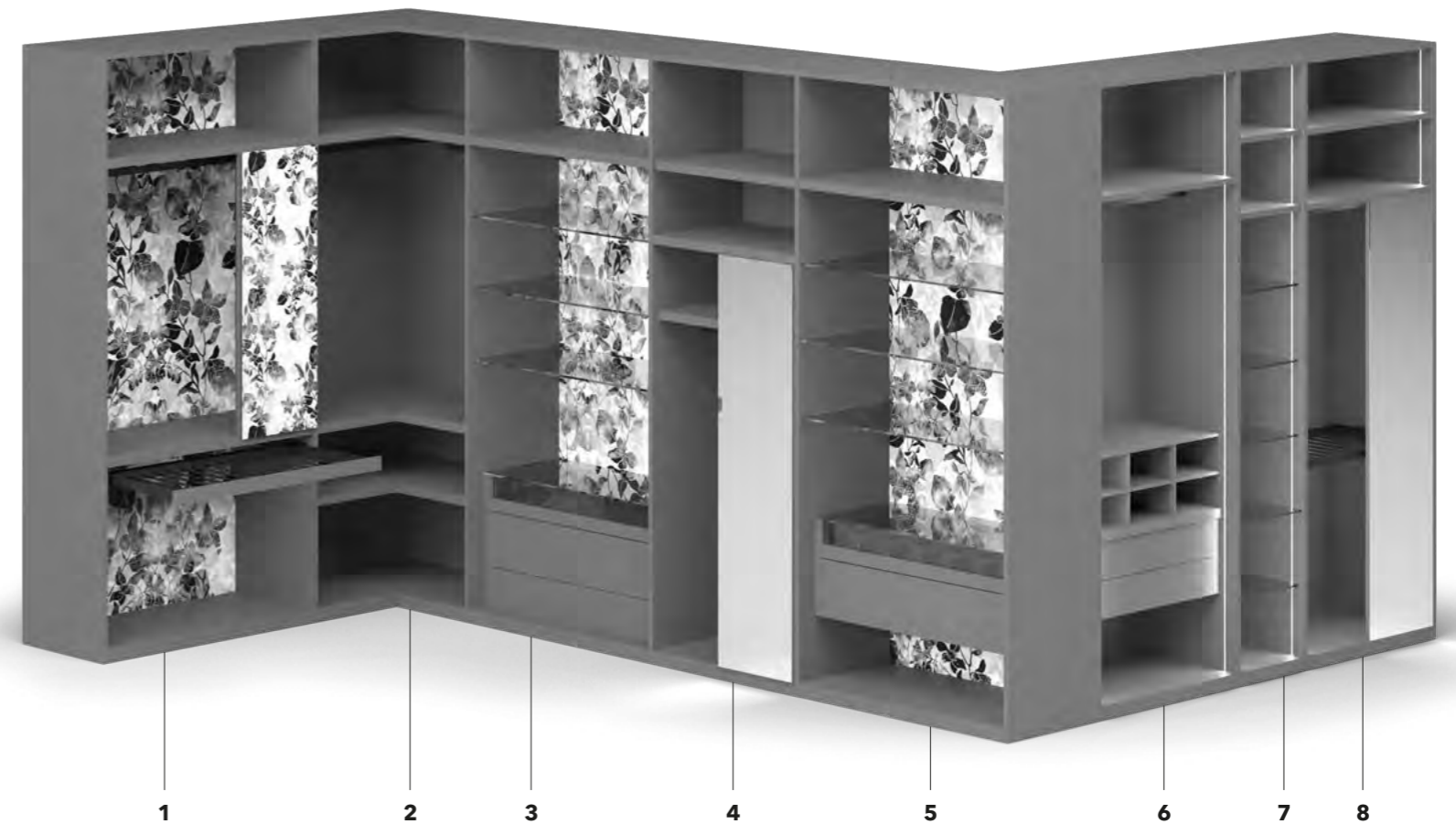

**1 /** Colonna larghezza 115.2 cm con schiena in nobilitato e stampa digitale con anta in luce in nobilitato e stampa digitale. Ripiano in legno con tubo appendiabito quadro bronzo/alluminio e ripiano estraibile porta pantaloni con frontalino in legno. Luce led a tutta altezza sui fianchi B347  
Column W 45 23/64" with back and flushed door in melamine finish with digital print. Wooden shelf with bronze/aluminum quadro hanging rail and bronze pull-out trouser rack shelf with wooden front part. Total height LED lights on sides B347

**2 /** Colonna ad angolo larghezza 102.7x102.7 cm con ripiani ad angolo e tubo appendiabiti quadro angolare bronzo/alluminio. Luce led a tutta altezza sui fianchi. Corner column W 40 7/16"x 40 7/16" with corner shelves, and bronze/aluminum quadro hanging rail. Total height LED lights on sides.

**3 /** Colonna larghezza 85.6 cm con schiena in nobilitato e stampa digitale, ripiani in vetro sp.1 cm e cassettera in appoggio con top in vetro, 2 cassettoni e un ripiano estraibile con frontale in vetro. Luce led a tutta altezza sui fianchi. B346  
Column W 33 45/64" with melamine and digital print

back, 25/64" th. glass and wooden shelves and chest of drawers with glass top, 2 high drawers and 1 pull-out shelf with glass front parts. Total height LED lights on sides with glass front B346.

**4 /** Colonna larghezza 85.6 cm con ripiani in legno e anta in luce con specchio. Luce led a tutta altezza sui fianchi B346  
Column W 33 45/64" width with wooden shelves and flushed door with mirror. Total height LED lights on sides B346.

**5 /** Colonna larghezza 85.6 cm con ripiani in legno e vetro sp. 1 cm, cassettera sospesa con top in vetro, ripiano estraibile con frontale in vetro e organizer.

Luce led a tutta altezza sui fianchi B346.  
Column W 33 45/64" with 25/64" th. Glass and wooden shelves, hanging chest of drawers with glass top and pull-out shelf with glass front and organizer. Total height LED lights on sides with glass front B346.

**6 /** Colonna larghezza 85.6 cm con ripiano in legno e tubo appendiabiti quadro bronzo/alluminio, cassettera sospesa con top in legno, due cassettoni e raster. Luce led a tutta altezza sui fianchi. B346  
Column W 33 45/64" with wooden shelf with bronze/aluminum quadro hanging rail, hanging chest of drawers with wooden top, 2 drawers and Raster. Total height LED lights on sides B346.

**7 /** Colonna larghezza 56.4 cm con ripiani in vetro sp. 1 cm e ripiani in legno. Luce led a tutta altezza sui fianchi. B345  
Column W 22 13/64" with 25/64" th. glass and wooden shelves. Total height LED lights on sides B345

**8 /** Colonna larghezza 85.6 cm con ripiano estraibile portapantaloni, ripiani in legno, tubo appendiabiti quadro bronzo/alluminio e anta in luce con specchio. B346  
Column W 33 45/64" with trouser rack shelf, wooden shelf, bronze/aluminum quadro hanging rail and flushed door with mirror. B346.



/ ANTE BATTENTI  
HINGEG DOORS

Componibili, personalizzabili, gli armadi ad anta battente di Tumidei, sono elementi di architettura personalizzabili ed adattabili alle necessità di chi li utilizza. Il sistema di ante tradizionali si trasforma grazie alle molteplici varietà maniglie e al gioco di colore e finiture, vetri e pattern dalla spiccata personalità.

*Modular, customizable, the Tumidei hinged wardrobes are architectural elements which can be customized and adjusted according to the user's needs.*

*The traditional doors system renews its design thanks to several handles, colors, finishes, glasses and patterns with a strong personality.*



**ANTE BATTENTI**  
MODULARITÀ CUT FREE  
**HINGED DOORS**  
CUT FREE MODULARITY

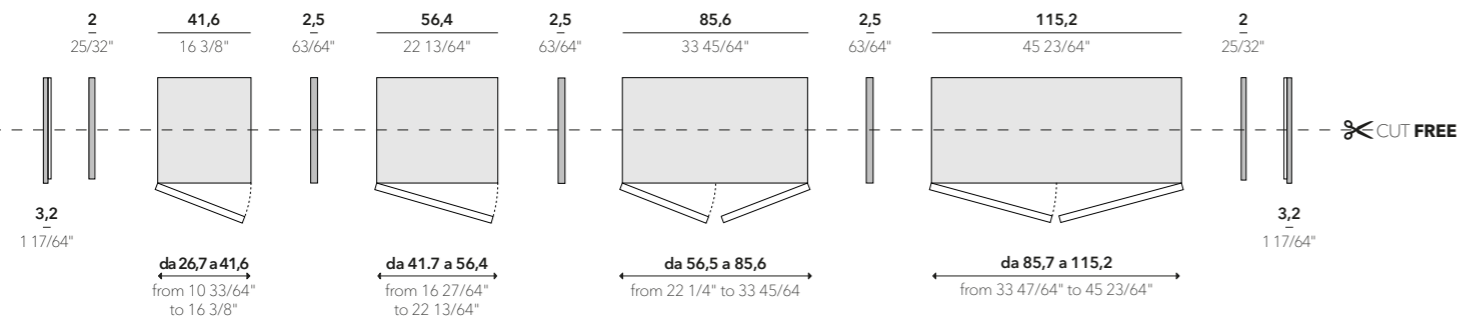
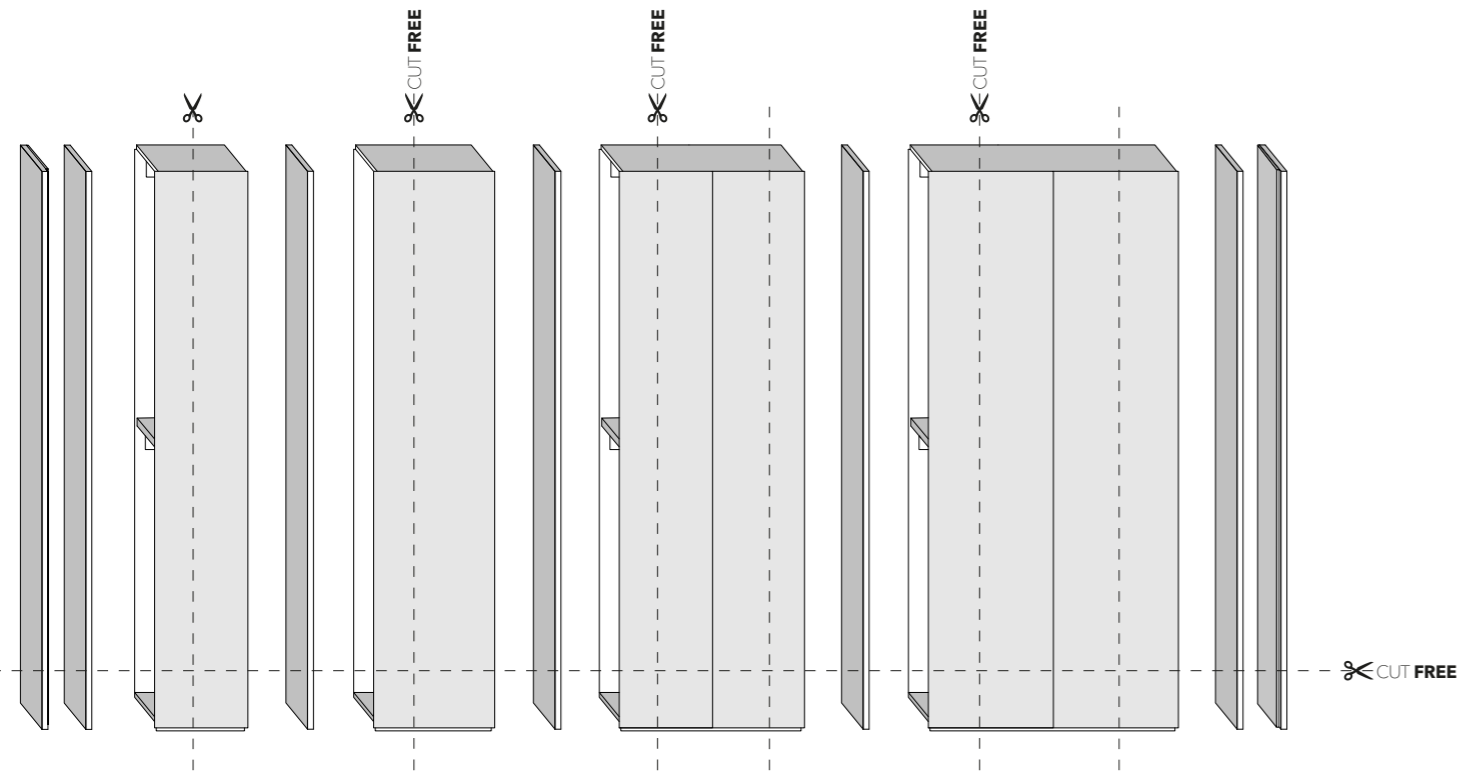

Profondità struttura da 18 a 102 cm  
Altezza struttura da 37 a 293 cm  
Structure depth from 7 3/32" to 40 5/32"  
Structure height from 14 9/16" to 115 23/64"

Fianco divisore 2,5 cm in finitura solo nobilitato per interni.

I fianchi finali 3.2/2 cm possono avere una doppia finitura: lato interno in finitura nobilitato per interni e lato esterno nobilitato, laccato, essenza e stampa digitale.

**N.B. Nel modulo da 41.6 cm base, cappello, ripiani, anta e schiena, subiscono maggiorazioni di taglio.**

I fianchi sono forati con passo 16 cm e sono forniti di serie con punzonatura totale e premontaggio della ferramenta per basi, cappelli, frontali e cassetti.

63/64" partition side in melamine for inner parts only

End sides 1 17/64" - 25/32" can be in double finish: internal facing in melamine finish for inner parts and external facing melamine, matt or glossy lacquered or wood and digital print.

**N.B. On item W 16 3/8", base, top, shelves, door and back panel are subjected to supplement for cut.**

Sides are drilled with a 6 19/64" range. Standard sides are supplied with total punching and pre-assembly of the hardware for bases, tops, front parts and drawers

**ANTE BATTENTI**  
**HINGED DOORS**

**STRUTTURA**  
**STRUCTURE**

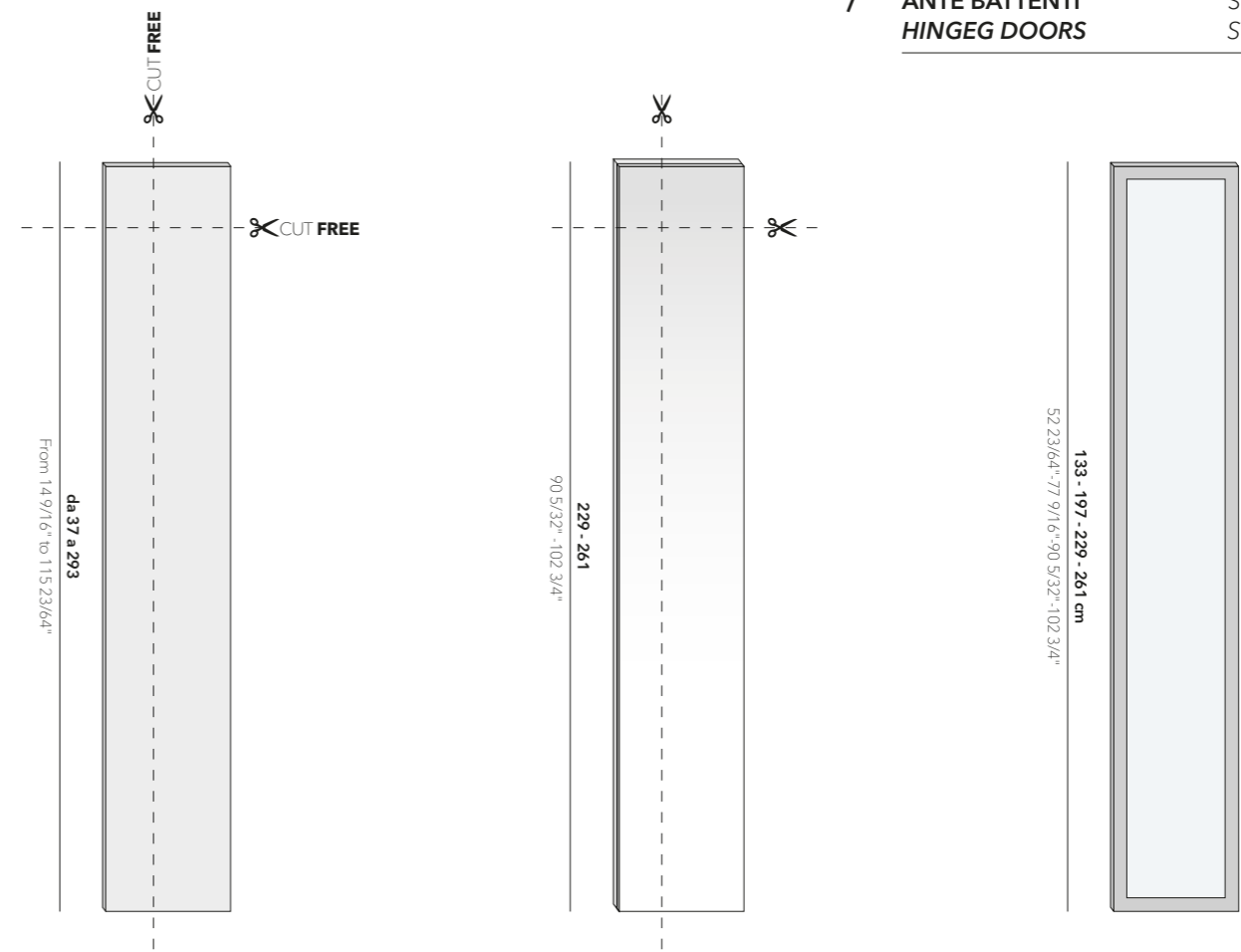

**ANTA IN LEGNO**  
**WOODEN DOOR**

Ante composte da pannelli nobilitati o laccati di particelle in legno spessore 2 cm, bordati sui 4 lati, cerniere a rientro rallentato. Anta in finitura nobilitato, laccato opaco e lucido, essenza opaca e lucida e stampa digitale. In questa tipologia di anta si possono inserire tutte le maniglie disponibili a listino

Doors composed by 25/32" th. panels of wooden particles with edges on 4 sides, and soft close hinges. Door in melamine, matt and glossy lacquered, matt and glossy wood finish and digital print. With this door type it is possible to select all kind of available handles.

**ANTA IN LEGNO + VETRO**  
**WOODEN DOOR + GLASS**

Ante composte da pannelli nobilitati o laccati di particelle di legno bordati sui 4 lati nella stessa finitura. Anta spessore 1.6 cm con vetro applicato spessore 0.4 cm. Cerniere a rientro rallentato. Anta in finitura nobilitato (nobilitato per interni), laccato e essenza. Vetro in finitura retro-laccato oppure in finitura specchio, specchio grigio o bronzato o con stampa digitale. In questa tipologia di anta si possono inserire solo le maniglie push-pull, Track, Line

Doors composed by melamine or lacquered panels of wooden particles with edge on 4 sides in the same finish. Door th. 5/8" with applied glass 5/32". Soft close hinges. Door in melamine (melamine for inner part only), lacquered and wood finish. Glass in back lacquered or mirror, grey mirror or bronzed glass mirror or with digital print. With this door type it is possible to select push pull, Track and Line handles only.

**ANTA VETRO CON TELAIO**  
**ALLUMINIO COLORE NERO**  
**GLASS DOOR WITH ALUMINUM**  
**BLACK FRAME**

Anta vetro con telaio in alluminio colore nero. Cornice interna spessore 2 cm, altezza telaio 4.5 cm. Vetro in finitura fumè o Stop Sol. Con vetro Fumè è possibile applicare la stampa digitale a righe orizzontali Nero o Tortora. Solo su vetro extrachiaro può essere applicata internamente la pellicola tessuto semi-trasparente di 6 diverse tonalità (Chalk Nero, Rock, Ash, Oak, Bone, Chalk Bianco). In questa tipologia disponibili solo maniglie push-pull.

Glass door with aluminum black frame. Inner frame th. 25/32", profile height 1 49/64". Smoked or Stop-Sol glass finish. With smoked glass it is possible to apply digital print with horizontal stripes Nero or Tortora. Semi-transparent raised fabric film with 6 colour variations (Chalk Nero, Rock, Ash, Oak, Bone, Chalk Bianco) can be applied on extra-clear glass only. With this door type, push-pull opening is exclusively available.

ARMADI CRISTAL  
CRISTAL WARDROBES

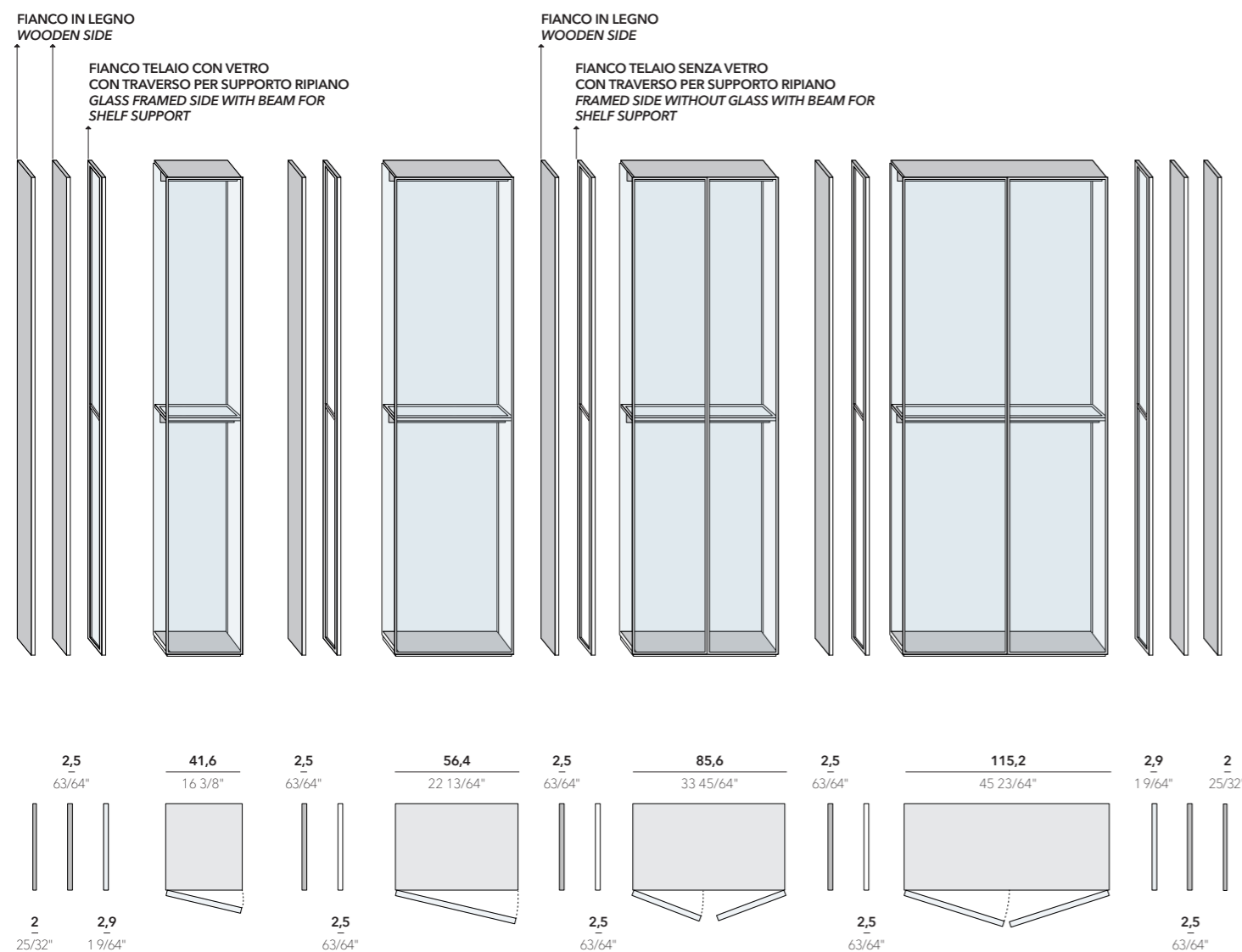

Profondità struttura  
fianco in legno  
da 18 a 56.8 cm  
Profondità struttura  
fianchi telaio 56.8 cm  
Altezza struttura H 261 cm

Wooden side structure  
depth from  
7 3/32" to 22 23/64"  
Framed side structure  
depth 22 23/64"  
Structure height h 102 3/4

I telai del fianco, delle ante e delle schiene montano vetro extrachiaro o vetro fumè temperato oppure vetro fume con righe nero/tortora. Nell'armadio Cristal le cerniere vengono alloggiare nello spessore della base e del cappello e dunque rimangono invisibili e non più d'ingombro quando vengono inseriti i ripiani. Ciò permette di evitare lavorazioni sui fianchi, garantendo, dal punto di vista estetico una maggiore pulizia visiva. Possibilità di scelta tra schiena in vetro e schiena in legno. Alla schiena in legno o

vetro, può essere applicata la stampa digitale. È inoltre possibile affiancare il sistema Cristal con armadi con anta battente piena legno e fianco in legno. Nei moduli Cristal non sono possibili tagli a misura in larghezza, altezza e profondità se è presente il fianco telaio, possibile taglio in profondità solo con fianchi e ripiani legno. Le maniglie bronzo finitura anta a tutta altezza sono integrate nel telaio garantendo eleganza e pulizia sporgendo di solo 1.3 cm per una corretta presa.

Side door and back frame have tempered extra-clear or smoked glass, or black/tortora horizontal stripes with smoked glass. In the Cristal wardrobe, hinges are fixed on base and top thickness, therefore, they remain invisible and no longer in bulk when shelves are inserted. This allows to avoid further workings on side, ensuring a greater cleanliness from an aesthetic point of view. It is possible to apply digital print on wooden or glass back. It is also possible to match

Cristal system with plain wooden doors and sides wardrobes. It is also possible to combine the Cristal system with wardrobes with full wooden doors and wooden sides. Crystal columns cannot be cut in width, height and depth. It is possible to cut on depth with wooden side and shelves only. The bronzed handles with full-height door finish are integrated into the frame with elegance and cleanliness, by protruding for 33/64" only for a correct grip.

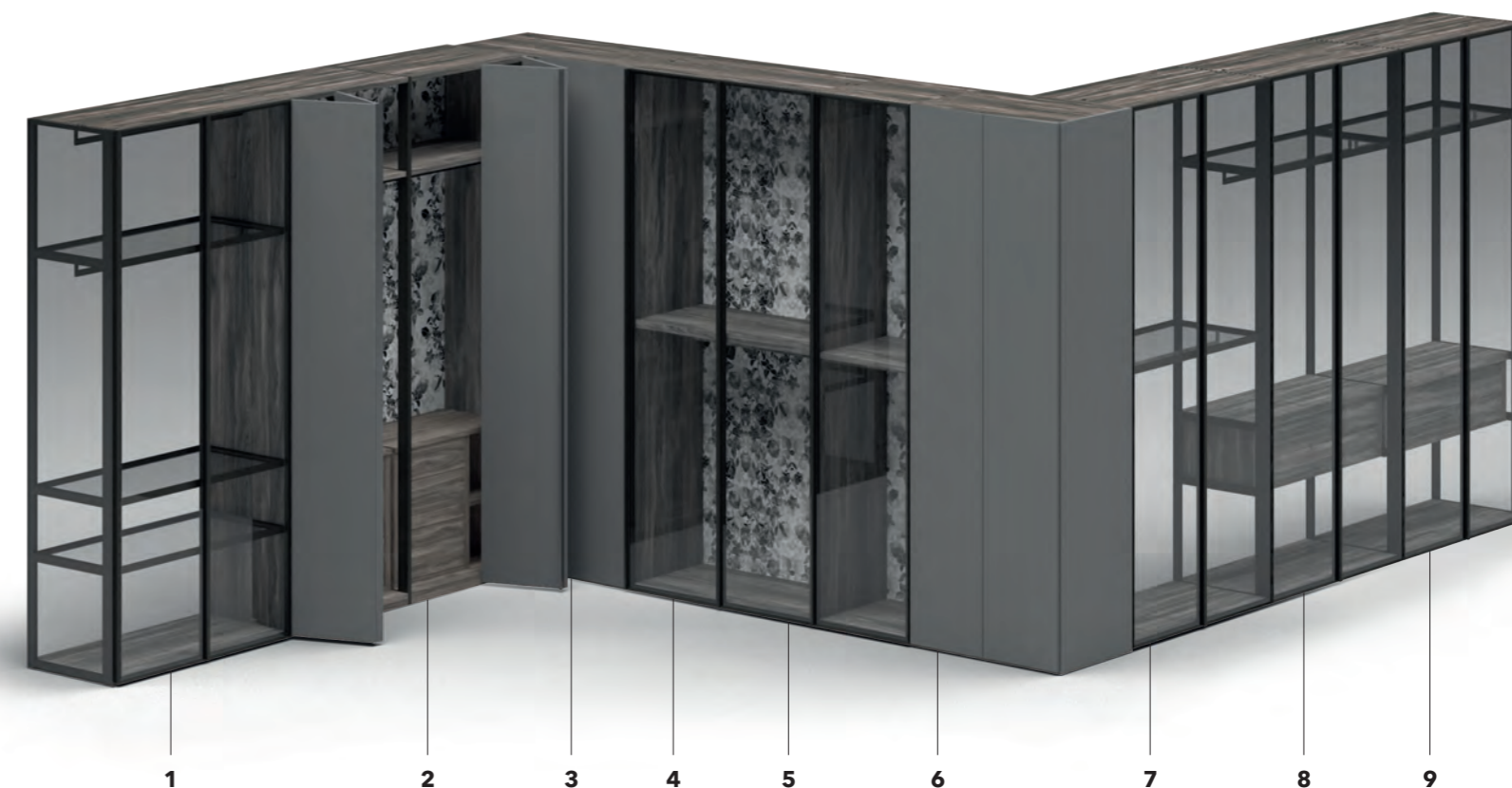

**1 /** Colonna CRISTAL larghezza 115.2 cm con fianco finale telaio e fianco divisore in legno e schiena in vetro. Ripiani con telaio vetro montati su fianchi vetro e legno.

Column W 45 23/64" with framed end side, wooden partition and glass back. Framed glass shelves fixed onto glass and wooden sides.

**2 /** n. 2 colonne larghezza 85.6 cm con fianco telaio divisore e ante a soffietto incernierate su fianco in legno, due ripiani in legno con tubo appendiabito quadro bronzo/alluminio e due cassettiere a 3 cassetti con top in legno e ripiani laterali. N. 2 columns W 33 45/64"

with framed partition and folding doors fixed on wooden side, two wooden shelves with bronze/aluminum quadro hanging rails, two chest of drawers with wooden top, 3 drawers and shelves.

**3 /** Cabina armadio lineare CARRY larghezza 85.6 cm, con un pannello fisso e una battente.

CARRY linear closet W 33 45/64" with one fixed panel and one hinged door.

**4 /** Colonna CRISTAL larghezza 85.6 cm con schiena in nobilitato + stampa digitale, ripiani in legno con tubi appendiabito quadro bronzo/alluminio.

CRISTAL column W 33 45/64" with back in melamine + digital print, wooden shelves with bronze/aluminum quadro hanging rails.

**5 /** Colonna CRISTAL larghezza 56.4 cm con schiena in nobilitato + stampa digitale, ripiani in legno con tubi appendiabito quadro bronzo/alluminio.

CRISTAL column W 22 13/64" with back in melamine + digital print, wooden shelves with bronze/aluminum quadro hanging rails.

**6 /** Colonna armadio battente larghezza 85.6 cm B146

Wardrobe column W 33 45/64" with hinged doors B146.

**7 / 8 / 9 /** Colonne CRISTAL larghezza 115.2 cm con schiena vetro, fianchi divisori telaio e fianchi terminali vetro telaio. Cassettiere con top in legno sospese e ripiani telaio vetro con tubi appendiabito.

CRISTAL columns width 45 23/64", with glass back, framed partitions and glass framed end sides. Hanging drawers with wooden top and glass framed shelves with hanging rails.

N.B.: L'anta battente in legno non può essere incernierata al fianco telaio, il fianco telaio divisore però può essere posto tra due moduli con anta soffietto purché l'anta soffietto sia incernierata in un fianco in legno.

N.B.: Wooden door cannot be hinged to the framed side, but the framed partition can be positioned between two folding doors units if these doors are hinged onto wooden sides.

**ANTE SCORREVOLI**  
MODULARITÀ CUT FREE  
SLIDING DOORS  
CUT FREE MODULARITY

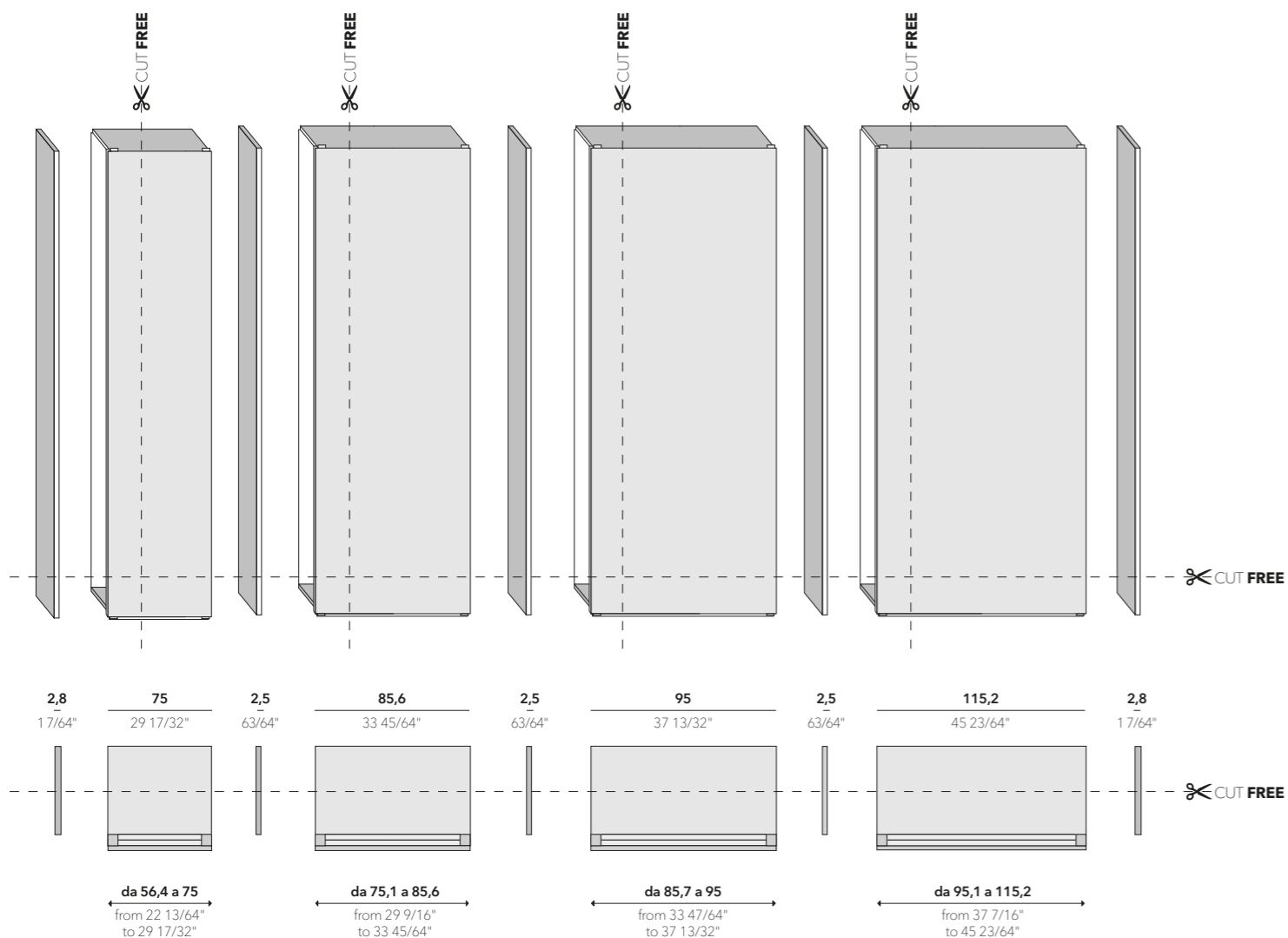

Profondità struttura da 46.2 a 60.5 cm  
Altezza struttura da 199 a 295 cm  
Structure depth from 18 3/16" to 23 13/16"  
Structure height from 78 11/32" to 116 9/64"

Di serie su tutti gli armadi scorrevoli viene fornita la chiusura rallentata ad azione magnetica.  
**Cut Free solo per colonne con ante totalmente in legno. I tagli su misura vengono invece conteggiati unicamente per il taglio del binario con chiusura ammortizzata, raddrizzanti, e ante con fasce verticali e orizzontali in Vetro.**

Magnetic action slow closing is provided as standard on all sliding wardrobes.  
**Cuts Free for wardrobes with plain wooden doors only. Custom cut are counted, instead, only for cutting the track with soft closing, straightening, and doors with vertical and horizontal glass strips.**

**ANTE SCORREVOLI**  
SLIDING DOORS  
STRUTTURA  
STRUCTURE

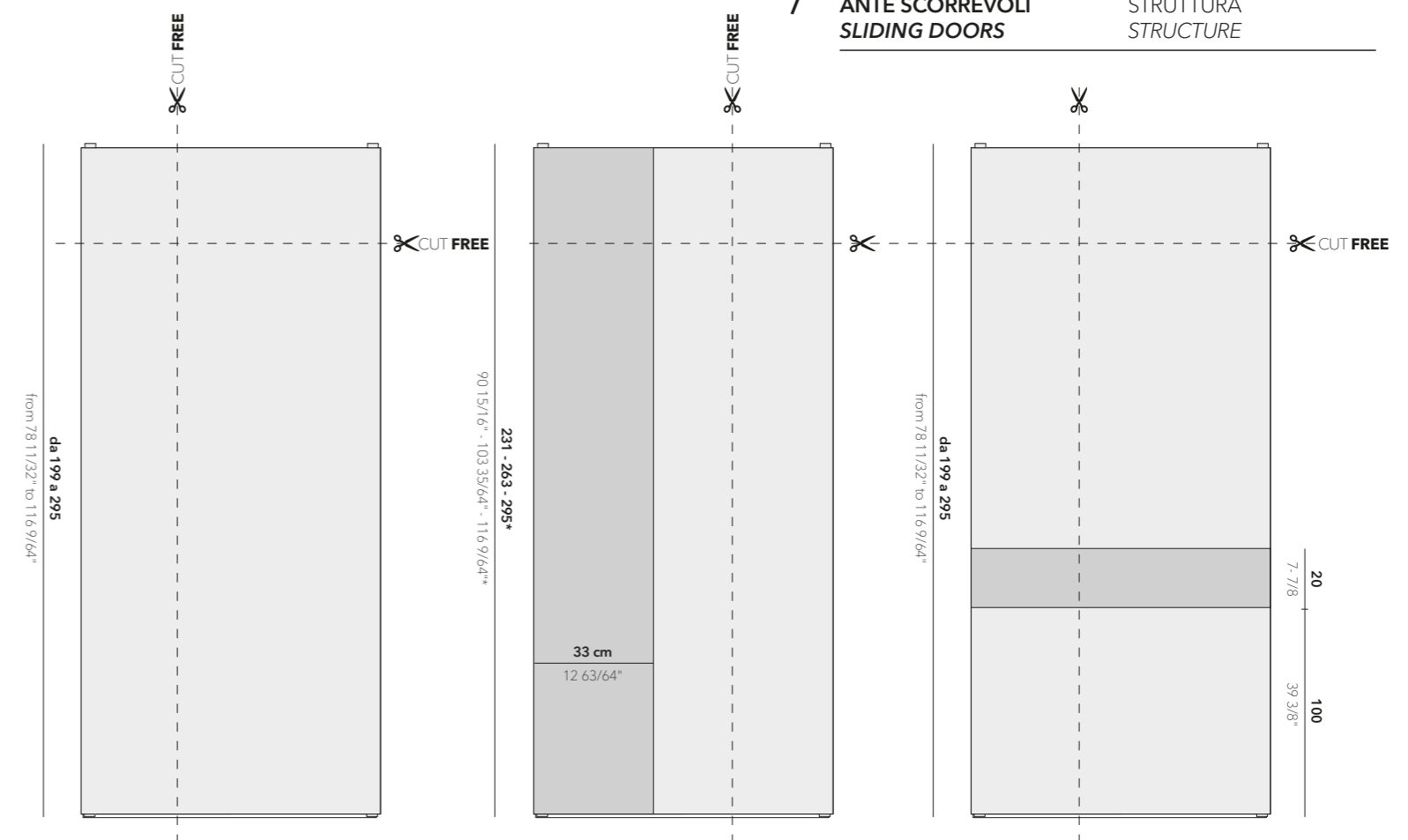

**ANTA SCORREVOLE IN LEGNO**  
WOODEN SLIDING DOOR

Ante composte da pannelli nobilitati o laccati di particelle di legno spessore 2 cm, bordati sui 4 lati, con maniglie laterali. Binari con chiusura ammortizzata. Ante in finitura nobilitato, laccato opaco e lucido, essenza ed essenza lucida o nobilitato con stampa digitale.

Doors composed by 25/32" th. panels of wooden particles in melamine and lacquered finish with edges on 4 sides with lateral handles.  
Aluminum rails with soft close.  
Door in melamine, matt or glossy lacquered, matt or glossy wood or melamine with digital print.

**ANTA SCORREVOLE IN LEGNO + FASCIA VERTICALE**  
WOODEN SLIDING DOOR + VERTICAL STRIP

Ante composte da pannelli nobilitati o laccati di particelle di legno spessore 2 cm, bordati sui 4 lati, con maniglie laterali. Ante in finitura nobilitato, laccato opaco e lucido, essenza ed essenza lucida o nobilitato con stampa digitale. Fascia verticale larghezza 33 cm in finitura nobilitato, laccato, vetro e stampa digitale. Binari con chiusura ammortizzata.  
\*H 295 fascia verticale in vetro non disponibile.

Doors composed by 25/32" th. panels of wooden particles in melamine and lacquered finish with edges on 4 sides with lateral handles  
Door in melamine, matt or glossy lacquered, matt or glossy wood or melamine with digital print.  
Vertical strip W 12 63/63" in melamine, lacquered, back lacquered or mirrored glass.  
\*H 116 9/64" glass vertical strip not available.

**ANTA SCORREVOLE IN LEGNO + FASCIA ORIZZONTALE**  
WOODEN SLIDING DOOR + HORIZONTAL STRIP

Ante composte da pannelli nobilitati o laccati di particelle di legno spessore 2 cm, bordati sui 4 lati con maniglie laterali. Ante in finitura nobilitato, laccato opaco e lucido, essenza ed essenza lucida. Fascia orizzontale altezza 20 cm in finitura vetro laccato o specchiato e stampa digitale. Binari con chiusura ammortizzata.

Doors composed by 25/32" th. panels of wooden particles in melamine and lacquered finish with edges on 4 sides with lateral handles.  
Door in melamine, matt or glossy lacquered, matt or glossy wood or or melamine with digital print.  
Horizontal strip 25/32" height in lacquered or mirrored glass and digital print.  
Rails with soft closing.



**/ MANIGLIE** ANTE SCORREVOLI  
**HANDLES** SLIDING DOORS

Maniglie disponibili per armadi scorrevoli:  
 Profile, Line, Track.

Handles available for sliding doors wardrobes:  
 Profile, Line, Track.



**PROFILE**

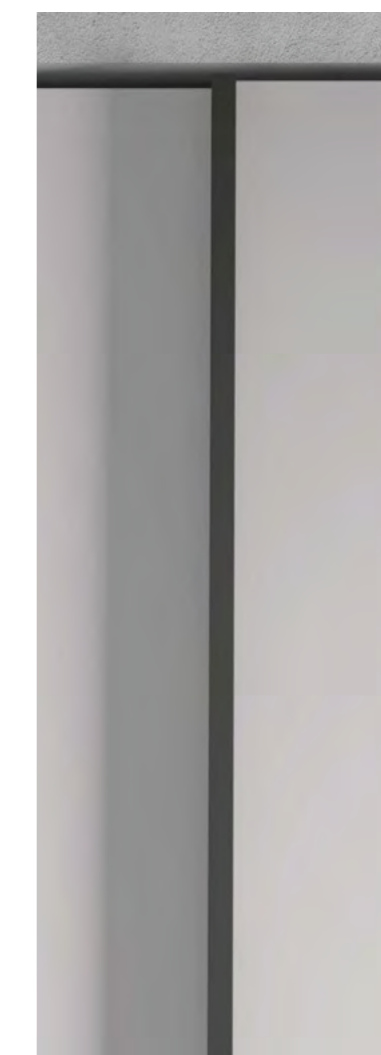

**LINE**

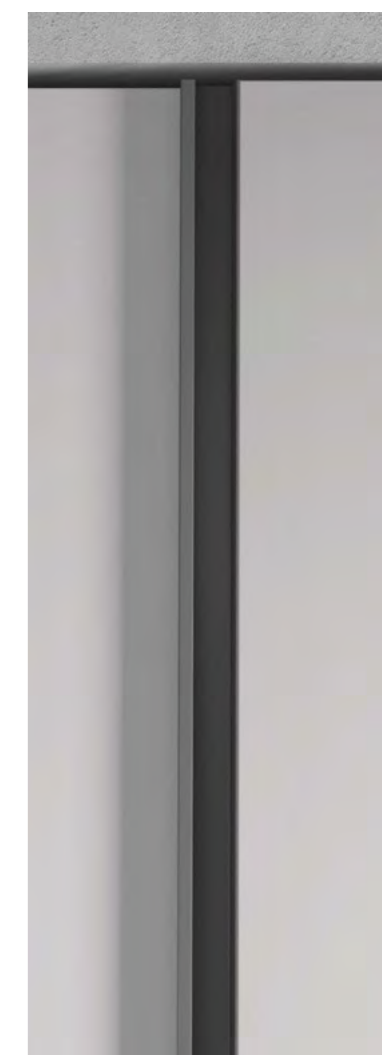

**TRACK**



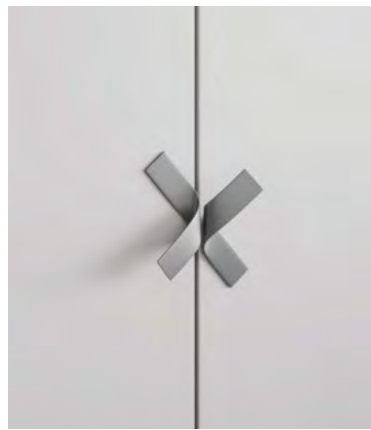

FIOCCO PM31



ARROW PM90S

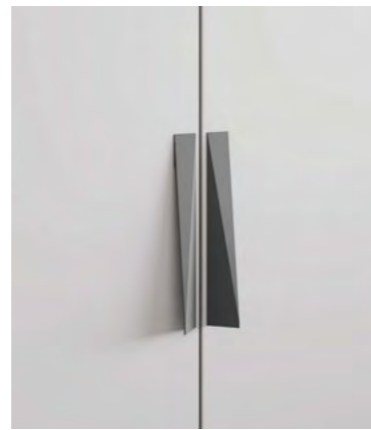

SAIL PM91



SIDE PM65/66/67

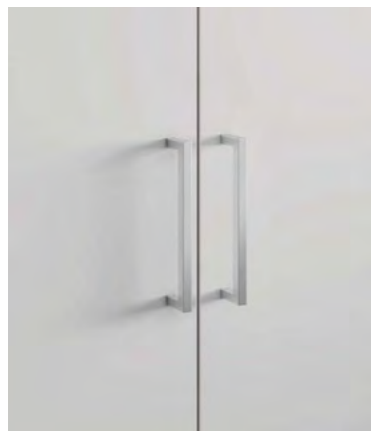

PX 04/05



PM 51/52



PM41B /42/43/44



PX 25/26/27/28/29



PX 08/09



PX 06/07



APERTURA PUSH PULL  
e SERRATURE

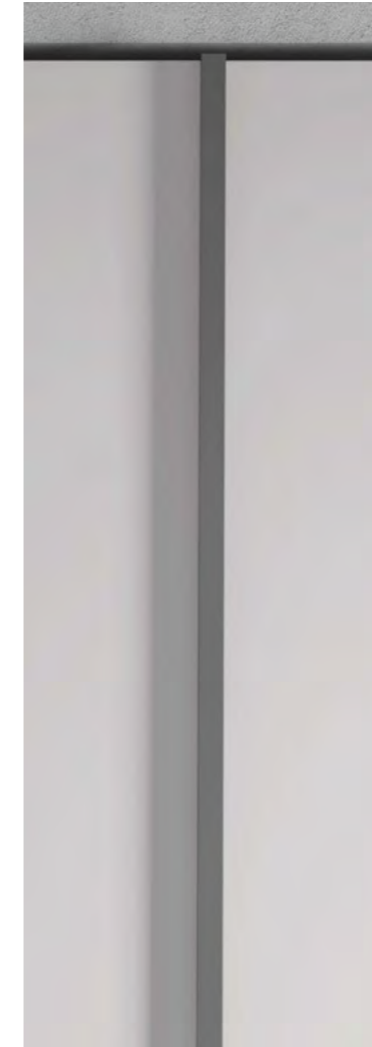

LINE



TRACK

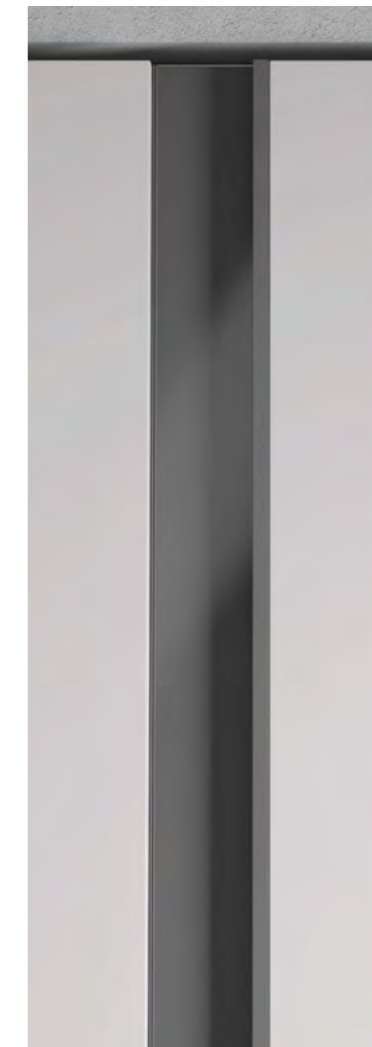

LOWE



CODE

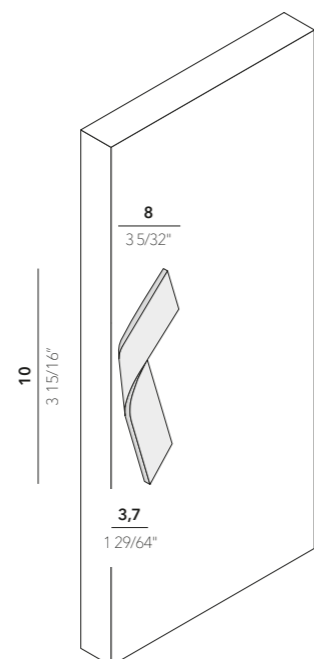
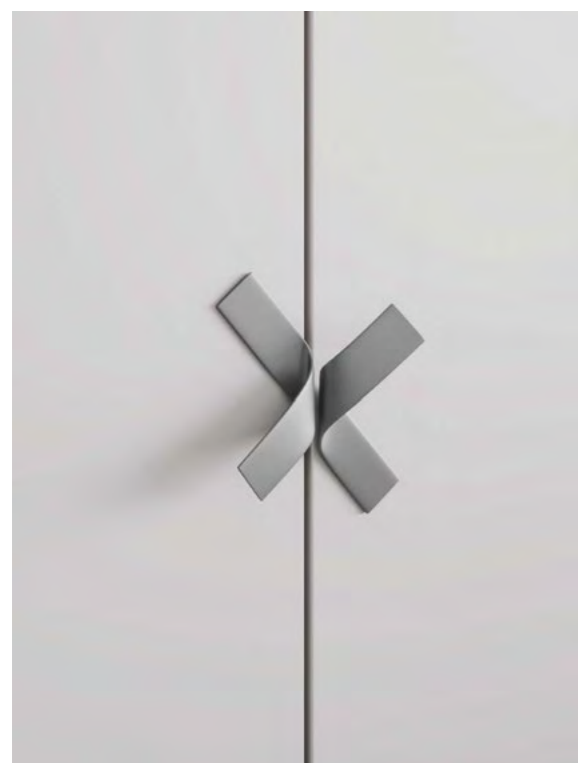

**FIOCCO** PM31

Maniglia in metallo  
solo finitura laccato  
Larghezza 8 cm  
Altezza 10 cm  
Spessore 3,7 cm

*Metal handle  
Lacquered finish only  
Width 3 5/32\"/>*

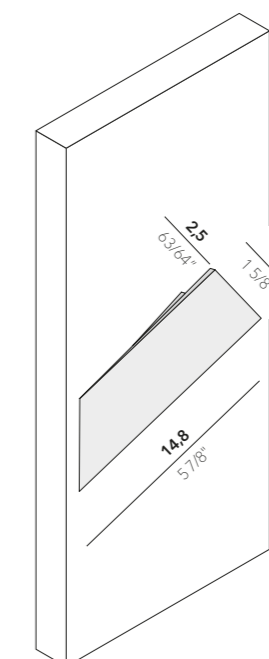

**ARROW** PM90S

Maniglia in metallo  
solo finitura laccato  
Larghezza 14,8 cm  
Altezza 4 cm  
Spessore 2,5 cm

*Metal handle  
Lacquered finish only  
Width 5 53/64\"/>*

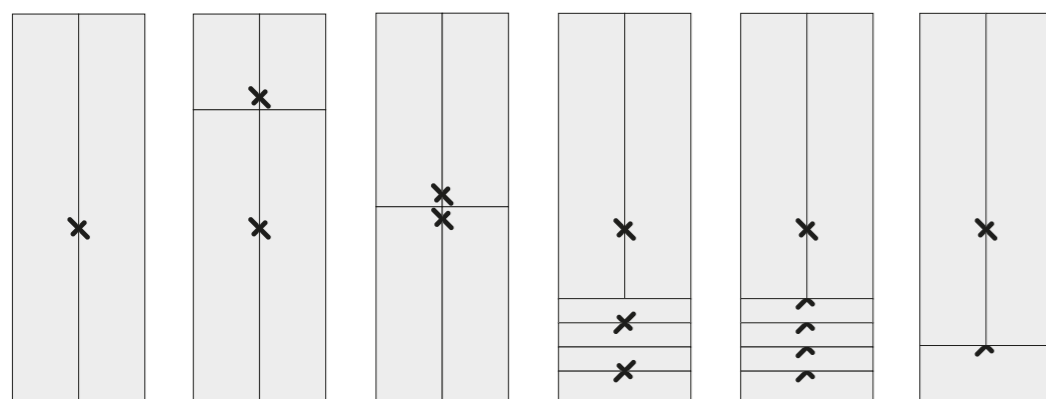

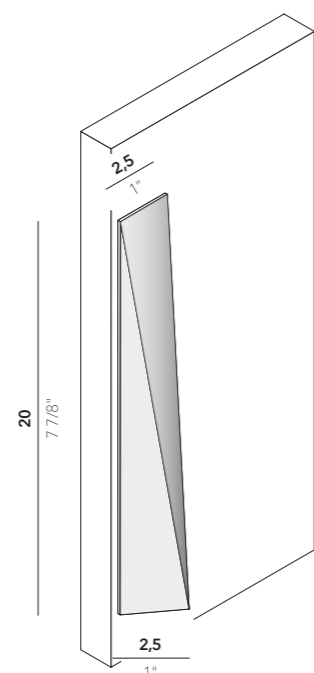

**SAIL PM91**

Maniglia in metallo  
solo finitura laccato  
Verso destra e sinistra  
Larghezza 2,5 cm  
Altezza 20 cm  
Spessore 2,5 cm

*Metal handle  
Lacquered finish only  
Right and left side  
Width 63/64"  
Height 7 7/8"  
Thickness 63/64"*

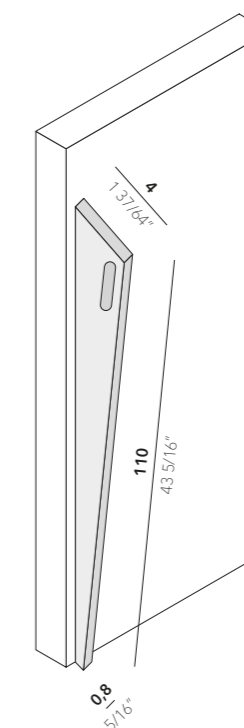

**SIDE PM65/66/67**

Maniglia in legno  
solo finitura laccato  
Larghezza 0,8 cm  
Altezza 11 - 20 - 110 cm  
Profondità 4 cm

*Wooden handle  
lacquered finish only  
Width 5/16"  
Height 4 21/64"-7 7/8"- 43 5/16"  
Depth 1 37/64"*

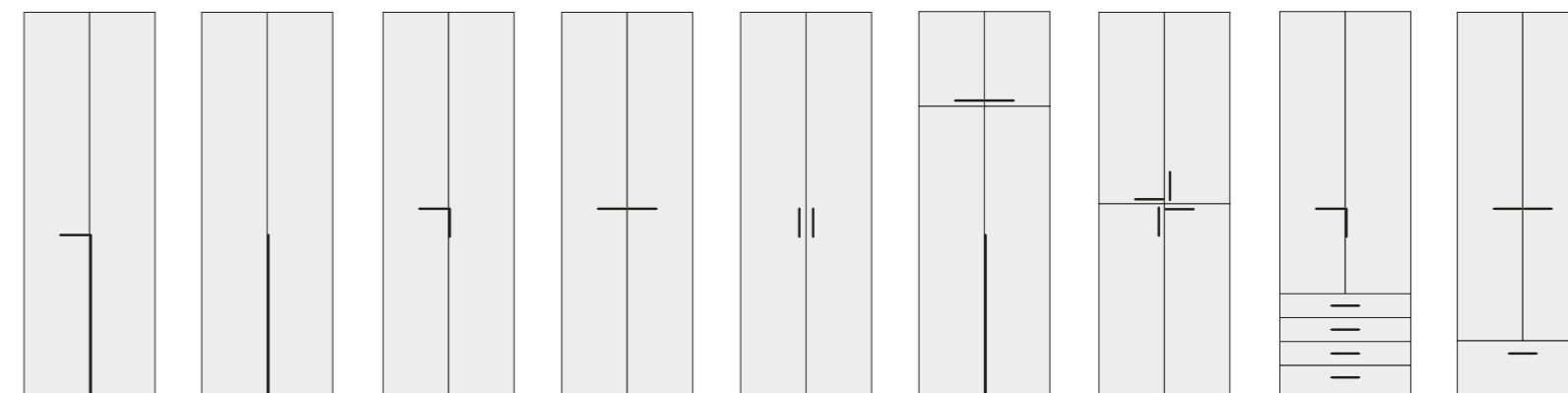
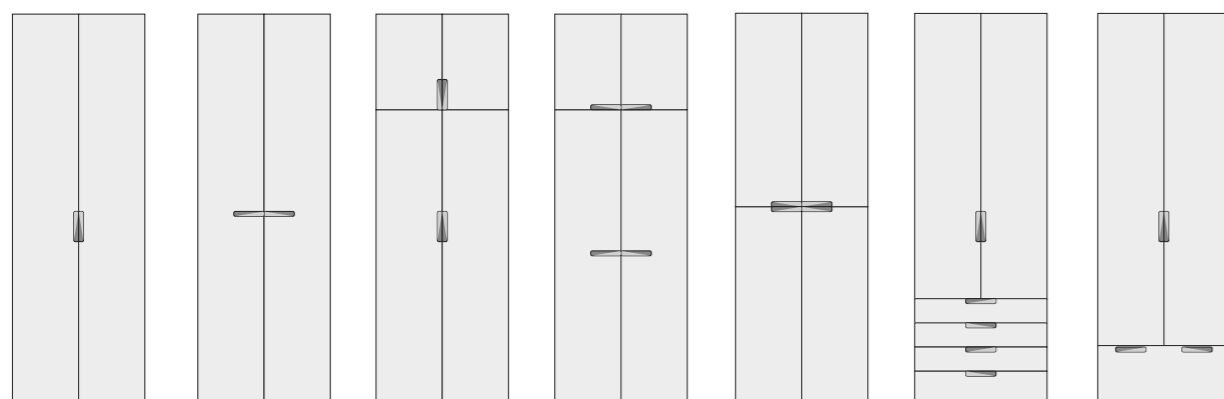

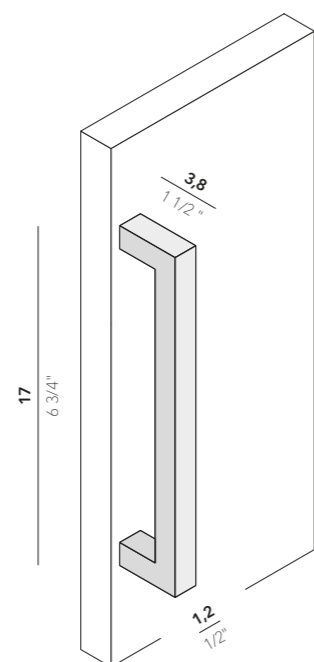

**PX 04/05**

Maniglia solo in finitura colore alluminio.  
Larghezza 1,2 cm  
Altezza 7,4 - 17 cm  
Profondità 3,8 cm

*Handle in aluminium colour only.*  
Width 15/32"  
Height 2 29/32" - 6 1/16"  
Depth 1 1/2"

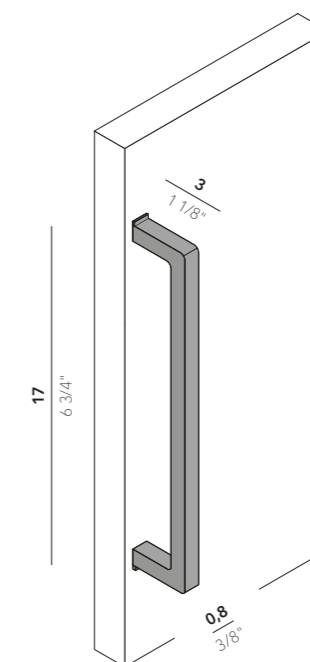

**PM 51/52**

Maniglia solo finitura colore nero  
Larghezza 0,8 cm  
Altezza 17 - 33 cm  
Profondità 3 cm

*Handles in black finish only*  
Width 5/16"  
Height 6 11/16"-12 63/64"  
Depth 1 3/16"

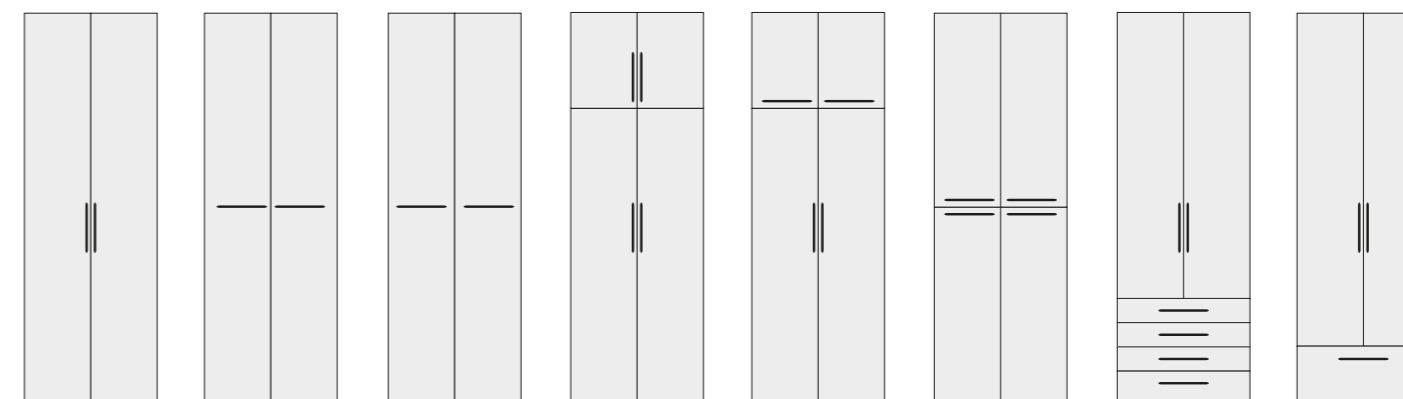
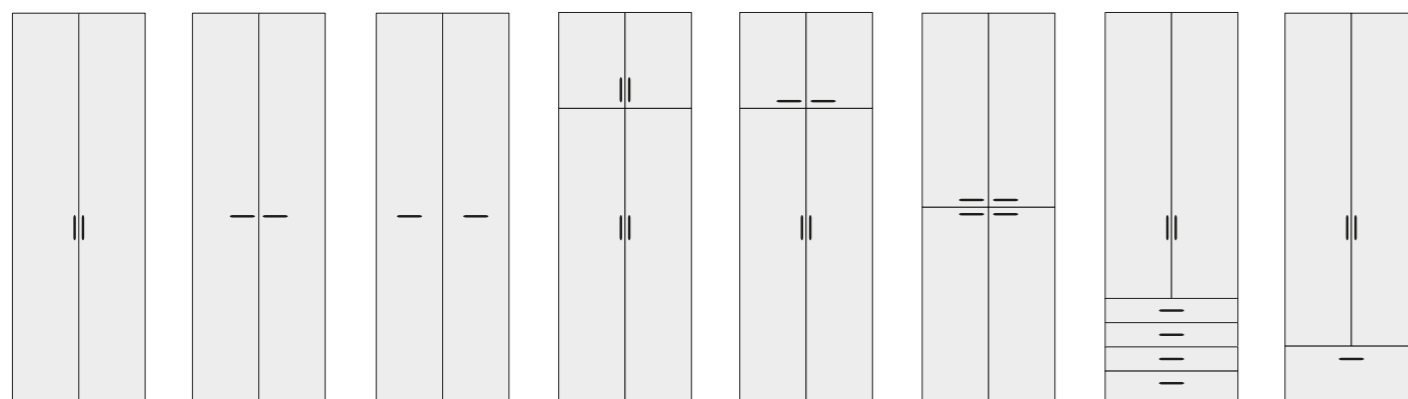

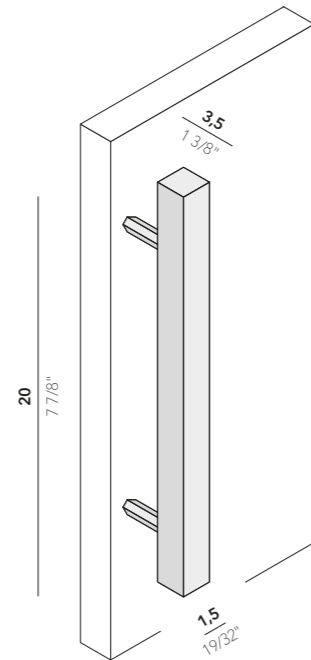

**PM 41B/42/43/44**

Maniglia in legno solo  
in finitura laccato.  
Larghezza 1,5 cm  
Altezza 20 - 33,8 - 48,6 - 84,4 cm  
Profondità 3,5 cm

Wooden handle  
lacquered finish only.  
Width 19/32"  
Height 7 7/8" - 13 15/16" - 19 9/64" - 33 15/64"  
Depth 1 3/8"

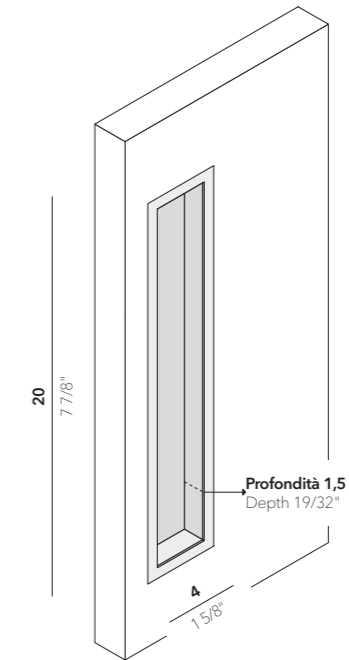

**PX 25/26/27/28/29**

Maniglia ad incasso con  
finitura nobilitato, laccato  
o essenza e bordo solo laccato.  
larghezza 4 cm  
Altezza 8 - 20 - 40 - 80 - 120 cm  
Profondità 1,5 cm

Recessed handle, melamine,  
lacquered or wood finish and  
edge lacquered only.  
Width 1 37/64"  
Height 3 5/32" - 7 7/8" - 15 3/4" - 31 1/2" - 47 1/4"  
Depth 19/32"

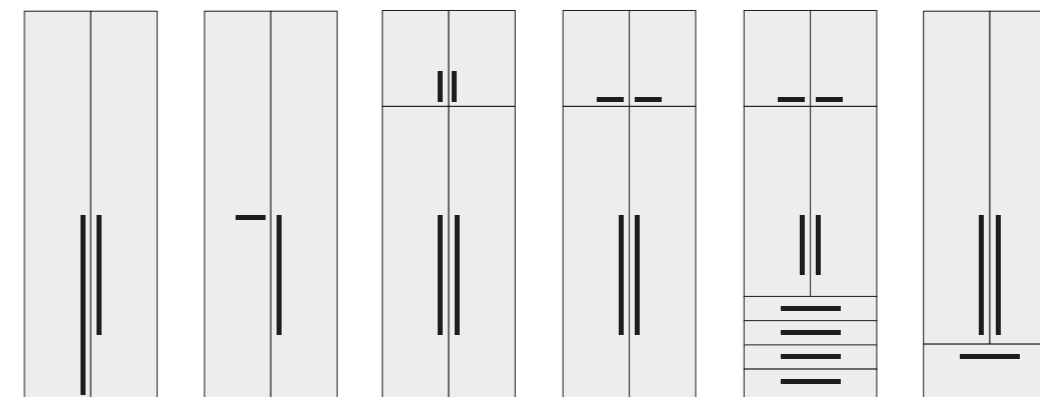
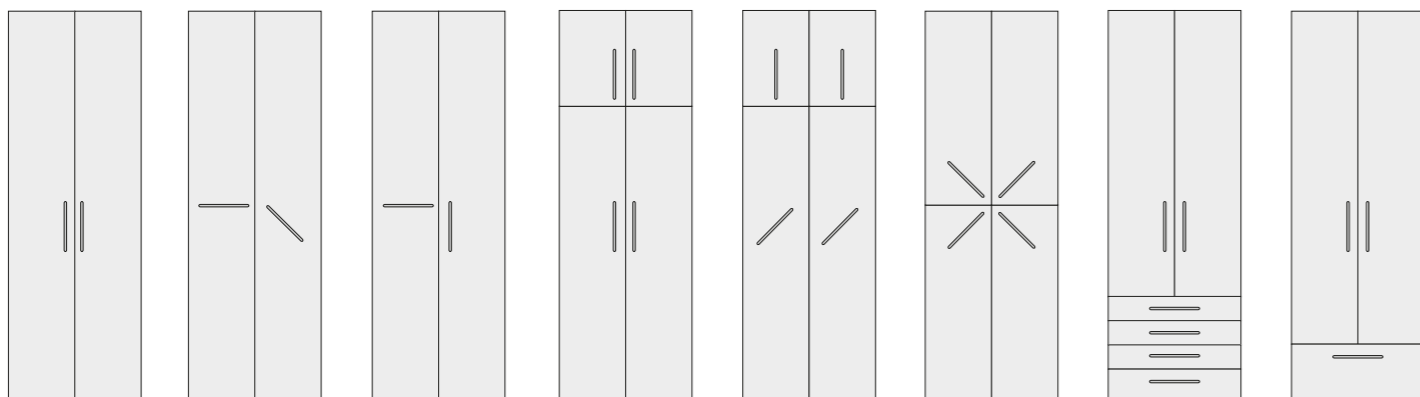

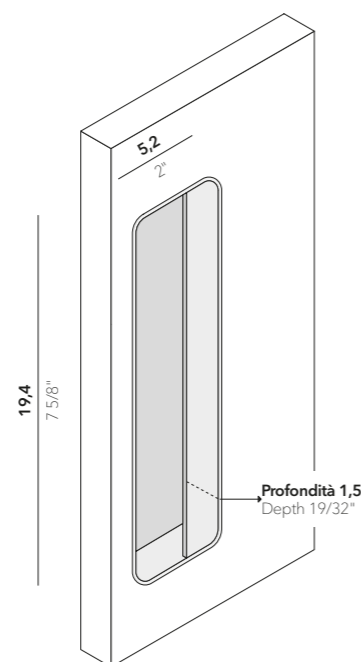

**PX 08/09**

Maniglia a incasso con presa solo finitura laccato.  
Larghezza 5,2 - 19,4 cm  
Altezza 5,2 cm  
Profondità 1,5 cm

*Rectangular recessed handle with grip lacquered finish only.  
Width 2 3/64" - 7 41/64"  
Height 2 3/64"  
Depth 19/32"*

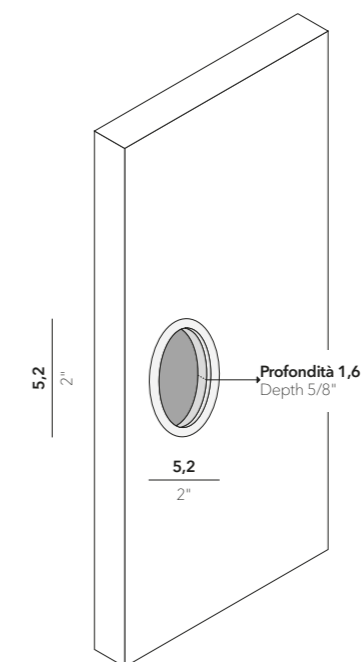

**PX 06/07**

Maniglia ad incasso circolare in finitura alluminio o bianco.  
Larghezza 3,5 - 5,2 cm  
Altezza 3,5 - 5,2 cm  
Profondità 1,6 cm

*Recessed circular handle Aluminum or white finish.  
Width 1 3/8" - 2 3/64"  
Height 1 3/8" - 2 3/64"  
Depth 5/8"*



**APERTURA PUSH-PULL  
PUSH-PULL OPENING**

Il push-pull va montato solo con ripiani profondità 54,9 cm e, per un funzionamento ottimale, posizionati al centro del vano utile. Solo per ante.  
*Push-pull mechanism must be installed on 21 39/64" depth shelves and, to achieve optimal functioning, in the center on the available space. To be used for doors only.*

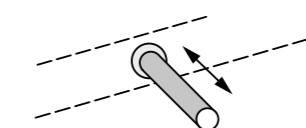

**MANIGLIA CON CHIAVE SR16  
HANDLE WITH KEY SR16**

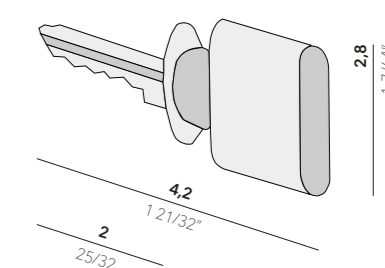

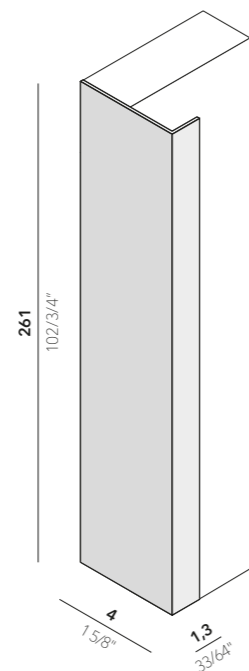

**LINE**

Maniglia in metallo  
Solo finitura laccato  
Utilizzabile esclusivamente della stessa  
altezza dell'anta.  
Disponibili anche su ante legno + vetro  
Larghezza 1,3 cm  
Altezza da 69 a 293  
Profondità 4 cm

*Metal handle  
Lacquered finish only  
to be used in the same height door only.  
Available for wood + glass door too  
Width 33/64"  
Height from 27 11/64" to 115 23/64"  
Depth 1 37/64"*

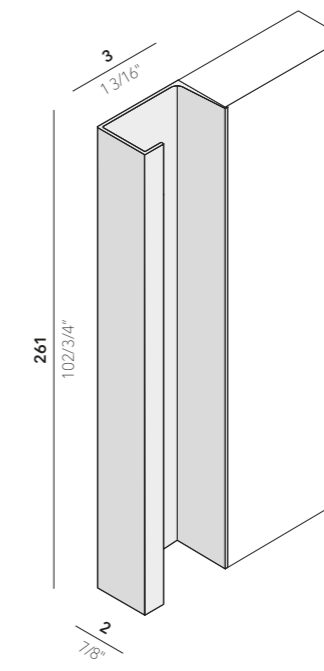
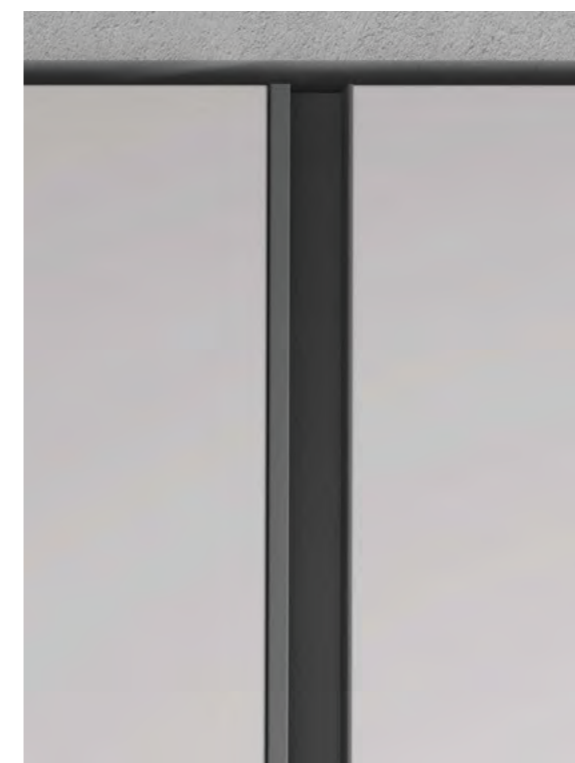
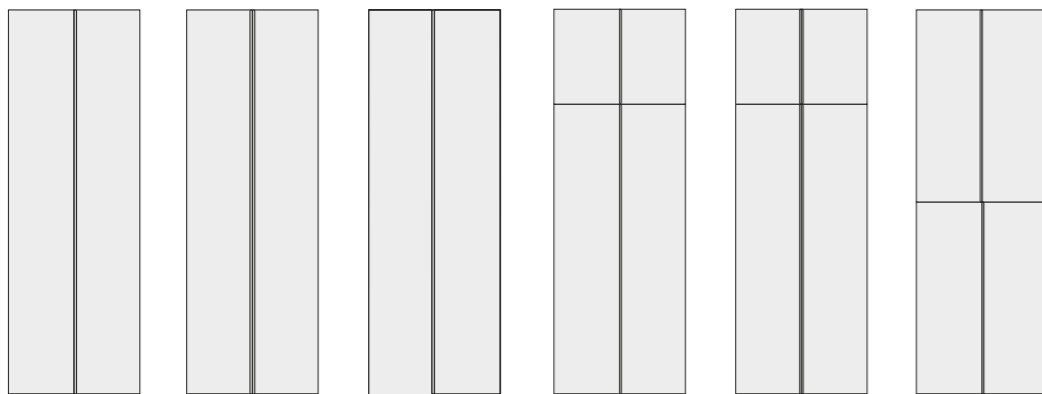

**TRACK**

Maniglia ad incasso in metallo.  
Solo finitura laccato.  
Utilizzabile esclusivamente  
della stessa altezza dell'anta.  
Disponibili anche su ante legno + vetro.  
Larghezza 3 cm  
Altezza da 69 a 293  
Profondità 2 cm

*Metal recessed handle  
Lacquered finish only  
to be used in the same height door only.  
Available for wood + glass door too.  
Width 1 3/16"  
Height from 27 11/64" to 115 23/64"  
Depth 1 37/64"*

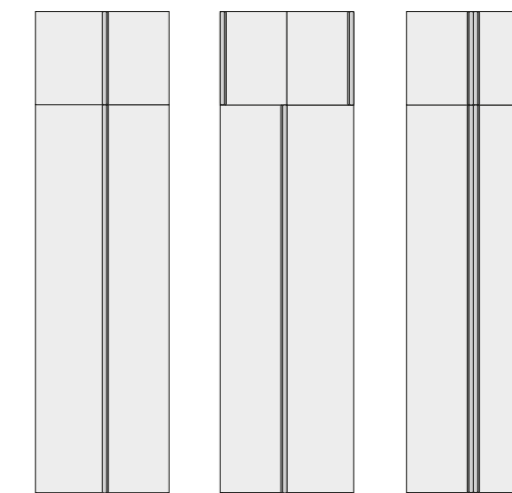
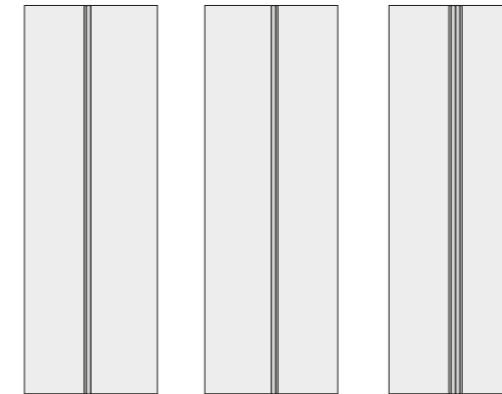

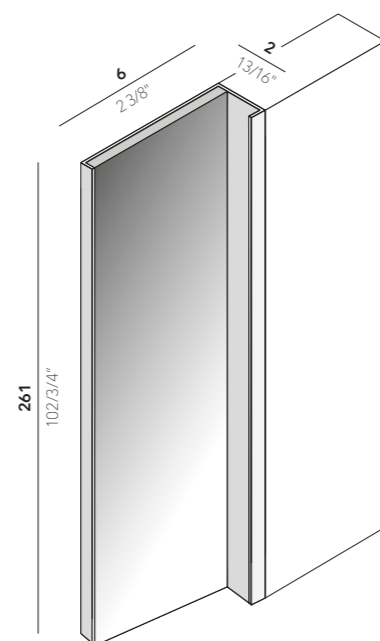
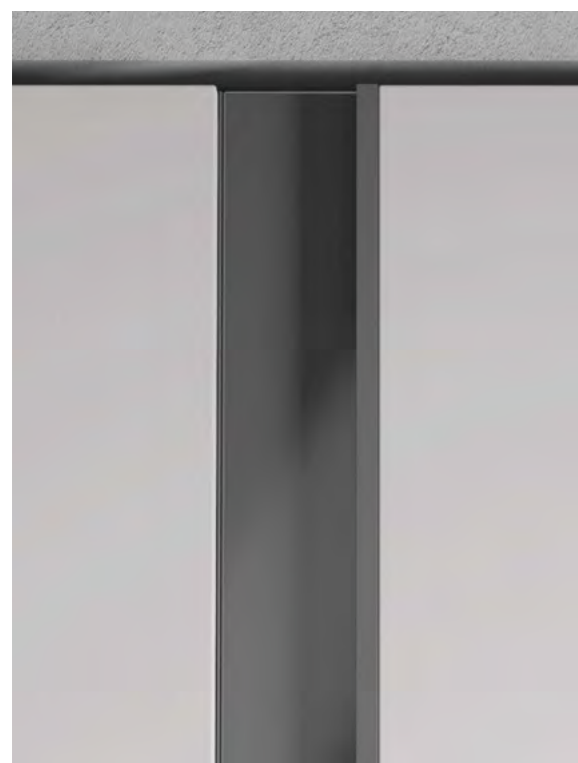

**LOWE**

Maniglia ad incasso in metallo solo finitura laccata con possibilità di inserire vetro specchiato o laccato e vetro con stampa digitale.  
Larghezza 6 cm  
Altezza da 69 a 293  
Profondità 2 cm  
Utilizzabile esclusivamente della stessa altezza dell'anta.

*Recessed metal handle  
Lacquered finish only with the possibility of applying mirrored or back-lacquered glass and digital print glass.  
Width 2 23/64"  
Height from 27 11/64" to 115 23/64"  
Depth 25/32"  
To be used in the same height door only.*



laccato  
lacquered



vetro specchiato  
bronzo/grigio  
mirrored/bronze  
grey glass



vetro  
retro laccato  
back lacquered  
glass



vetro con  
stampa digitale  
glass with  
digital print

**SISTEMA FUNZIONALE E VERSATILE**

La serie di maniglie ad incasso Lowe, si sviluppano su tutto il profilo verticale dell'anta armadio, creando un gioco con le molteplici finiture che dà carattere al sistema armadio, mantenendo eleganza e pulizia. Possono essere personalizzate con le laccature della gamma Tumidei, o in finitura vetro laccato e specchio, ed è possibile personalizzarle con stampe digitali Vetro permettendo l'abbinamento ai tessuti del campionario Tumidei.

**FUNCTIONAL AND VERSATILE RECESSED SYSTEM**

The Lowe series of recessed handles develop over the whole vertical profile of the wardrobe door, creating a game with multiple finishes that gives character to the wardrobe system, maintaining elegance and cleanliness. They can be customized with the wide range of TUMIDEI lacquered colours, or in lacquered glass and mirror finish, and can be customized with digital prints on glass allowing the combination with the fabrics of the Tumidei samples page.

**ESEMPI DI COMPOSIZIONE  
EXAMPLES OF CONFIGURATION**





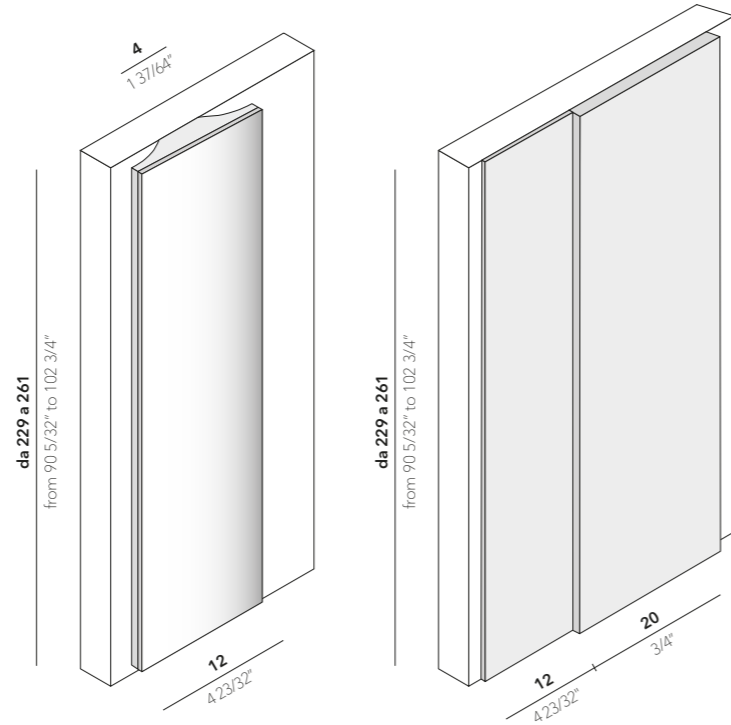

**CODE** design Simone Cagnazzo

Maniglia in legno  
Finitura nobilitato Bianco e Antracite, laccato opaco o lucido, Vetro laccato o specchiato o stampa digitale  
Utilizzabile esclusivamente della stessa altezza dell'anta.  
Larghezza 12-20 cm  
Altezza da 229 a 261 cm  
Profondità 2 cm

Wooden handle  
Antracite and Bianco melamine finish, matt or glossy lacquered, lacquered or mirrored glass or digital print.  
To be used in the same height door only  
Width 4 23/32"-7 7/8"  
Height from 90 5/32" to 102 3/4"  
Depth 25/32"

**CODE LIGHT**

Fascia decorativa in legno sp. 1,2 cm o in vetro sp. 0,4 cm, necessaria l'aggiunta di push-pull, oppure maniglia Track o Line.  
Disponibile in nobilitato (tutte le finiture) laccati, vetro retro-laccato, vetro specchiato o con stampa digitale.

Wood th. 15/32" or glass th 5/32" decorative strip, push-pull, or Track or Line handle is necessary.  
Available in melamine (all melamine), lacquered finish, lacquered glass, mirrored glass or with digital print.



**PM 63/64**  
larghezza 12 cm  
**PM 63/64**  
width 4 23/32"



**PM 61/62**  
larghezza 20 cm  
**PM 61/62**  
width 7 7/8"



**CODE LIGHT**  
larghezza 12 e 20 cm  
sp. 1,2 cm in legno  
sp. 0,4 cm in vetro  
**CODE LIGHT**  
width 4 23/32" - 7 7/8"  
wood thickness 15/32"  
glass thickness 5/32"



nobilitato  
bianco/antracite  
bianco antracite  
melamines



laccato lucido  
o opaco  
glossy or matt  
lacquered



vetro specchiato  
bronzo/grigio  
mirrored/bronzed  
grey glass



vetro  
retro laccato  
back lacquered  
glass



stampa digitale su  
nobilitato o vetro  
digital print on  
melamine or glass

**SISTEMA FUNZIONALE E VERSATILE**

La serie di maniglie Code, si sviluppano su tutto il profilo verticale dell'anta armadio, creando un gioco di pieni e vuoti, che dà carattere al sistema armadio.  
Sono disponibili in due differenti larghezze, possono essere personalizzate con le laccature della gamma Tumidei, in finitura vetro retro laccato e specchio abbinare al nobilitato o alla finitura laccata opaco. Inoltre è possibile personalizzarle con la grande collezione di grafiche presenti nel catalogo Tumidei, tramite stampe digitali su maniglia CODE in nobilitato o su vetro.

**ESEMPI DI COMPOSIZIONE  
EXAMPLES OF CONFIGURATION**

La maniglia Code può essere montata a 10 cm oppure a filo anta.  
The Code handle can be assembled at 3 15/16" or on the door edge.

**FUNCTIONAL AND VERSATILE SYSTEM**

The set of Code handles expands throughout all the vertical profile of the wardrobe door, creating a trick of fullness and emptiness which gives personality to the entire wardrobe system. They are available in two different widths and can be customized with the Tumidei lacquered colours, , back lacquered or mirrored glass matching with melamine or matt lacquered finishes. In addition to that, it is possible to customize them by using the great range of TUMIDEI images collection and adding digital print on Melamine or Glass Code handle.

**CODE**

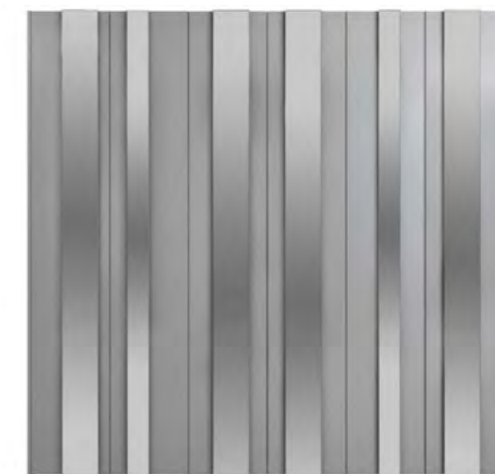

**CODE LIGHT**





/ **ATTREZZATURE INTERNE** ALLESTIMENTO INTERNO  
**INTERNAL EQUIPMENT** INTERNAL ACCESSORIES

Una vasta gamma di accessori e finiture offre la possibilità di organizzare e gestire gli spazi interni degli armadi garantendo funzionalità ed eleganza.

*A wide range of accessories and finishes offers the possibility to organize and manage the internal spaces of the wardrobes, guaranteeing functionality and elegance.*



**1/**

Nobilitato BIANCO  
*BIANCO melaminee*



**2/**

Nobilitato GHIACCIO  
*GHIACCIO melamine*



**3/**

Nobilitato TRAMA TESSUTO  
*TRAMA TESSUTO melamine*



**4/**

Nobilitato PELLE ANTRACITE  
*PELLE ANTRACITE melamine*



**5/**

Nobilitato OLMO GRIGIO  
*OLMO GRIGIO melamine*



**6/**

Nobilitato NOCE  
*NOCE melamine*



**7/**

Nobilitato OLMO SCURO  
*OLMO SCURO melamine*



**8/**

Schiena con STAMPA DIGITALE applicabile su pannelli in Nob. BIANCO, TRAMA TESSUTO e OLMO CALCE

*DIGITAL PRINT on back panel can be applied to BIANCO, TRAMA TESSUTO and OLMO CALCE melamine.*

Schiena sp. 0,8 o 1,6 cm, base, cappello, divisori spessore 2,5 cm e ripiani spessore 2,5 e 4 cm disponibili solo nelle 7 finiture.

*Back th. 5/16" o 5/8", base, top, shelves and 63/64" side partitions and 63/64" and 1 37/64" can be in melamine finishes for inner part only.*



9/

Interni Nob. BIANCO, ripiani Nob. BIANCO, cassettera e Raster Nob. OLMO CALCE

*Inner structure BIANCO melamine, shelves BIANCO melamine, chest of drawers and Raster OLMO CALCE melamine*



10/

Interni Nob. GHIACCIO, ripiani Nob. GHIACCIO, cassettera e Raster Nob. OLMO BIO

*Inner structure GHIACCIO melamine, shelves GHIACCIO melamine, chest of drawers and Raster OLMO BIO melamine*

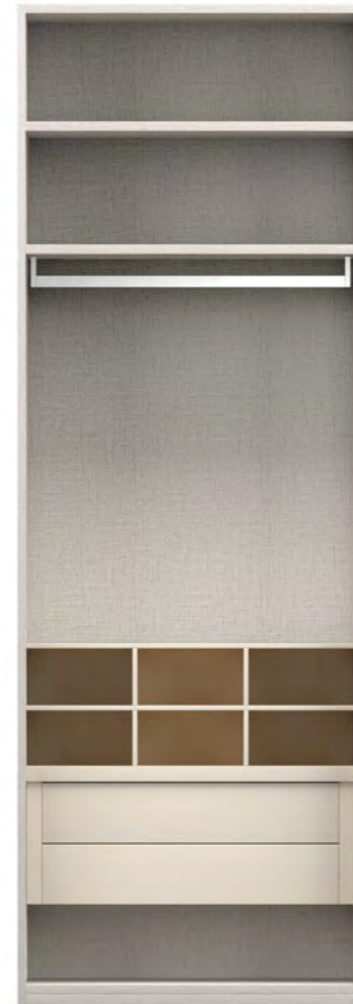

11/

Interni Nob. TRAMA TESSUTO, ripiani Nob. TRAMA TESSUTO, cassettera e Raster Nob. LIMO

*Inner structure TRAMA TESSUTO melamine, shelves TRAMA TESSUTO melamine, chest of drawers and Raster LIMO melamine*



12/

Interni Nob. PELLE ANTRACITE, ripiani Nob. PELLE ANTRACITE, cassettera e Raster Nob. laccati MUSCHIO

*Inner structure PELLE ANTRACITE melamine, shelves PELLE ANTRACITE melamine, chest of drawers and Raster MUSCHIO lacquered*



13/

Interni Nob. OLMO GRIGIO, ripiani Nob. OLMO GRIGIO, cassettera e Raster Nob. TORTORA

*Inner structure OLMO GRIGIO melamine, shelves OLMO GRIGIO melamine, chest of drawers and Raster TORTORA melamine*

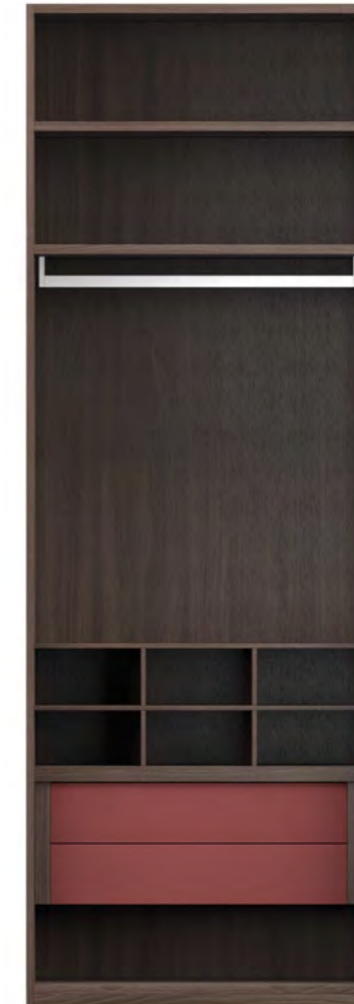

14/

Interni Nob. OLMO SCURO, ripiani Nob. OLMO SCURO, cassettera e Raster Nob. OLMO SCURO con frontali laccato RIBES e Raster Nobilitato OLMO SCURO

*Inner structure OLMO SCURO, melamine,shelves OLMO SCURO melamine, chest of drawers OLMO SCURO with front parts RIBES lacquered and Raster OLMO SCURO melamine*



15/

Interni Nob. PELLE ANTRACITE con stampa digitale su schiena, ripiani Nob. PELLE ANTRACITE, cassettera laccata LAVAGNA con frontali con stampa digitale e Raster laccato LAVAGNA

*Inner structure PELLE ANTRACITE melamine with digital print on back panel,shelves PELLE ANTRACITE melamine, chest of drawers LAVAGNA lacquered with digital print on front parts and Raster LAVAGNA lacquered*

I cassetti e i raster possono avere finitura nobilitato e laccato. Sui frontali può essere applicato il vetro laccato o specchiato, con o senza stampa digitale. Schiena sp. 0,8 o 1,6 cm. Base, cappello, divisori spessore 2,5 cm e ripiani, disponibili solo nelle 7 finiture per interni (bianco, trama tessuto, ghiaccio, olmo grigio, olmo scuro, pelle antracite, noce).

*Drawers and Raster can be in melamine and lacquered finish. Front parts can be with applied lacquered or mirrored glass, with or without digital print. Back th. 5/16" o 5/8", base, top, shelves and 63/64" side partitions can be in melamine finishes for inner part only (bianco, trama tessuto, ghiaccio, olmo grigio, olmo scuro, pelle antracite, noce).*



**A/**

1 ripiano in legno  
 2 tubi appendiabiti quadro  
 bronzo/alluminio

*1 wooden shelf  
 2 bronze/aluminum quadro  
 hanging rails*

**B/**

3 ripiani in legno  
 1 tubo appendiabiti quadro  
 bronzo/alluminio  
 1 cassettera con top in legno con  
 1 cassetto

*3 wooden shelves  
 1 bronze/aluminum quadro  
 hanging rail  
 1 chest of drawer with wooden top  
 1 high drawer*

**C/**

1 ripiano in legno  
 1 servetto bronzo/alluminio  
 1 tubo appendiabiti quadro  
 bronzo/alluminio  
 1 cassettera con top in legno con  
 1 cassetto e 1 cassetto

*1 wooden shelf  
 1 bronze/aluminum clothes lift  
 1 bronze/aluminum hanging rail  
 1 chest of drawer with wooden top  
 1 high drawer and 1 drawer*

**D/**

1 ripiano in legno  
 1 servetto bronzo/alluminio  
 1 tubo appendiabiti quadro  
 bronzo/alluminio  
 1 cassettera 3 cassetti con 1 top  
 in legno e 1 ripiano laterale

*1 wooden shelf  
 1 bronze/aluminum clothes lift  
 1 bronze/aluminum quadro  
 hanging rail  
 1 chest of drawer  
 with wooden top  
 3 drawers  
 and 1 shelf*

**E/**

5 ripiani in legno  
 1 tubo appendiabiti quadro  
 bronzo/alluminio  
 1 divisore centrale  
 1 cassettera con top in legno 4  
 cassetti

*5 wooden shelves  
 1 bronze/aluminum quadro  
 hanging rail  
 1 partition  
 1 chest of drawer  
 with wooden top and  
 4 drawers*

**F/**

1 ripiano in legno  
 1 servetto bronzo/alluminio  
 1 raster a 6 vani  
 e doppio divisore  
 1 cassettera con top in legno  
 1 cassetto e 4 cassetti

*1 wooden shelf  
 1 bronze/aluminum clothes lift  
 1 raster with 6 compartments and  
 double vertical partitions  
 1 chest of drawers with wooden  
 top with 1 high drawer and  
 4 drawers*

**G/**

1 ripiano in legno  
 1 servetto bronzo  
 1 raster a 6 vani  
 con divisore singolo  
 1 cassettera con 2 cassetti  
 1 ripiano estraibile e 1 ripiano  
 estraibile con frontale in vetro  
 e organizer

*1 wooden shelf  
 1 bronze/aluminum clothes lift  
 1 raster with 6 compartments  
 and single vertical partition  
 1 chest of drawers with 2 drawers  
 1 pull-out shelf  
 1 pull-out shelf with glass front*



115 23/64"  
 102 3/4"  
 90 45/64"  
 78 7/64"  
 65 33/64"  
 52 29/32"  
 40 5/16"  
 27 23/32"  
 15 1/8"  
 2 13/32"  
 0

293  
 261  
 230,4  
 198,4  
 166,4  
 134,4  
 102,4  
 70,4  
 38,4  
 6,1  
 0

**H/**

1 ripiano in legno  
 1 servetto bronzo  
 1 raster a 8 vani con divisore singolo  
 1 cassetiera con 1 cassettone e 2 ripiani estraibili con frontale in vetro

*1 wooden shelf  
 1 bronze/aluminum clothes lift  
 1 raster with 8 compartments and single partition  
 1 chest of drawers with 1 high drawer and 2 pull-out shelves with glass front*

**I/**

1 ripiano in legno  
 1 tubo appendiabiti quadro bronzo/alluminio  
 1 raster a 6 vani con doppio divisore  
 1 cassetiera con 1 cassettone sospeso

*1 wooden shelf  
 1 bronze/aluminum quadro hanging rail  
 1 raster with 6 compartments and double partition  
 1 hanging chest of drawers with 1 high drawer*

**J/**

2 ripiani in legno  
 1 tubo appendiabiti quadro bronzo/alluminio  
 1 cassetto sospeso con top in legno

*2 wooden shelves  
 1 bronze/aluminum quadro hanging rail  
 1 hanging chest of drawer with wooden top*

**K/**

2 ripiani in legno  
 1 tubo appendiabiti bronzo/alluminio  
 1 ripiano estraibile e organizer con top legno

*2 wooden shelves  
 1 quadro bronze/aluminum hanging rail  
 1 pull-out shelf and organizer with wooden top*

**L/**

2 ripiani in legno  
 1 ripiano in vetro spessore 1 cm  
 1 tubo appendiabiti quadro bronzo/alluminio  
 1 ripiano estraibile con frontale e top in vetro e organizer

*2 wooden shelves  
 1 glass shelf th. 0 25/64"  
 1 bronze/aluminum quadro hanging rail  
 1 pull-out shelf with glass front and top and organizer*

**M/**

2 ripiani in legno  
 1 ripiano in vetro spessore 1 cm  
 1 tubo appendiabiti quadro bronzo/alluminio  
 1 cassetto e 1 ripiano estraibile con frontale e top in vetro e organizer

*2 wooden shelves  
 1 glass shelf th. 0 25/64"  
 1 bronze/aluminum quadro hanging rail  
 1 drawer and 1 pull-out shelf with glass front and top and organizer*

**N/**

2 ripiani in vetro extrachiaro con profilo bronzo  
 2 tubi appendiabiti quadro bronzo/alluminio

*2 extra-clear glass shelves with bronze profile  
 2 bronze/aluminum quadro hanging rails*



**O/**

1 ripiano in vetro extrachiario con profili bronzo  
 1 tubo appendiabiti quadro bronzo/alluminio  
 2 ripiani vetro spessore 1 cm  
 1 ripiano estraibile con frontale in vetro e top legno

*1 extra-clear glass shelf with bronze profiles  
 1 bronze/aluminum quadro hanging rail  
 2 glass shelves th. 25/64"  
 1 pull-out shelf with glass front and wooden top*

**P/**

1 ripiano in legno  
 1 tubo appendiabiti quadro bronzo/alluminio  
 1 ripiano estraibile bronzo  
 1 ripiano estraibile in vetro con profili bronzo  
 1 ripiano estraibile porta pantaloni

*1 wooden shelf  
 1 quadro bronze/aluminum hanging rail  
 1 bronze pull-out shelf with bowl  
 1 bronze profile pull-out glass shelf  
 1 bronze profile pull-out trousers rack shelf*

**Q/**

2 ripiani in legno  
 1 servetto bronzo/alluminio  
 1 ripiano estraibile portapantaloni con profilo bronzo

*2 wooden shelves  
 1 bronze/aluminum clothes lift  
 1 pull-out trouser rack shelf with bronze profiles*

**R/**

2 ripiani in legno  
 1 servetto bronzo/alluminio  
 1 ripiano estraibile portapantaloni con profilo bronzo

*2 wooden shelves  
 1 bronze/aluminum clothes lift  
 1 pull-out trouser rack shelf with bronze profiles*

**S/**

7 ripiani portascarpe con profili bronzo/alluminio

*7 shoes rack shelves with bronze/aluminum profiles*

**T/**

7 ripiani in legno sp. 2.5 cm  
 7 wooden shelves 63/64" th.

**U/**

7 ripiani in legno sp. 4 cm  
 7 wooden shelves 1 37/64"

**RIPIANO IN LEGNO**  
**WOODEN SHELF**



Ripiano in legno con  
 finitura nobilitato per  
 interno in 7 varianti.  
 Larghezza  
 da 41.6 a 115.2 cm  
 Profondità  
 da 18 a 98.9 cm  
 Spessore 2.5-4 cm  
 \*nel modulo  
 da 115.2 cm solo sp.4 cm

*Wooden shelf in  
 melamine for inner parts  
 finish in 7 variation  
 Width from  
 16 3/8" to 45 23/64"  
 Depth from  
 7 3/32" to 38 15/16"  
 Thickness  
 63/64"-1 37/64"  
 \*1 37/64" for units  
 W 45 23/64" only*

**RIPIANO CONTENITORE**  
**ESTRAIBILE**  
**PULL-OUT SHELF**  
**WITH BOWL**



Ripiano contenitore  
 estraibile finitura bronzo  
 per modulo da  
 85.6 - 115.2 cm  
 Profondità 56.8 cm  
 Altezza 9 cm

*Pull-out shelf with bowl  
 bronze finish  
 Unit 33 45/64" - 45 23/64"  
 Depth 22 23/64"  
 Height 3 35/64"*

**RIPIANO IN VETRO**  
**GLASS SHELF**



Ripiano in vetro  
 extrachiaro con  
 reggi-ripiano bronzo  
 per modulo  
 da 41.6 - 56.4 - 75 - 85.6  
 95 - 115.2 cm  
 Profondità 53.7 cm  
 Spessore 1 cm

*Extra-clear glass shelf with  
 bronze shelf support  
 For unit from  
 16 3/8" - 22 13/64"  
 29 17/32" - 33 45/64"  
 37 13/32" - 45 23/64"  
 Depth 21 9/64"  
 Thickness 25/64"*

**RIPIANO PORTASCARPE**  
**SHOES RACK SHELF**



Ripiano portascarpe  
 Profili bronzo/alluminio  
 per modulo da 41.6 - 56.4  
 85.6 - 115.2 cm  
 Profondità 54.4 cm  
 Spessore 2.5 - 4 cm

*Shoes rack shelves  
 bronze/aluminum profile  
 Unit from 16 3/8"  
 22 13/64" - 33 45/64"  
 45 23/64"  
 Depth 21 27/64"  
 Thickness 63/64" - 1 37/64"*

**RIPIANO VETRO CON**  
**TELAIO BRONZO**  
**GLASS SHELF WITH**  
**BRONZE FRAME**



Ripiano in vetro  
 extrachiaro  
 con telaio bronzo  
 per modulo da 41.6 - 56.4  
 85.6 - 115.2 cm  
 Profondità 53.7 cm  
 Spessore 3.5 cm

*Extra-clear glass shelf with  
 bronze shelf support  
 Unit from  
 16 3/8" - 22 13/64"  
 33 45/64" - 45 23/64"  
 Depth 21 9/64"  
 Thickness 1 3/8"*

**RIPIANO ESTRAIBILE**  
**IN VETRO**  
**PULL OUT**  
**GLASS SHELF**



Ripiano estraibile  
 in vetro extrachiaro  
 con telaio bronzo  
 per modulo da  
 85.6 - 115.2 cm  
 Profondità 56.8 cm  
 Altezza 5 cm

*Pull-out glass shelf  
 with bronze frame  
 Unit 33 45/64" - 45 23/64"  
 Depth 22 23/64"  
 Height 1 31/32"*



**RIPIANO  
PORTAPANTALONI  
ESTRAIBILE  
TROUSERS PULL-OUT  
RACK SHELF**



Ripiano porta pantaloni  
estraiabile finitura Bronzo  
Per moduli  
da 85.6 - 115.2 cm  
Profondità 56.8 cm  
Altezza 5 cm

*Trouser rack pull out shelf  
Unit 33 45/64" - 45 23/64"  
Depth 22 23/64"  
Height 1 31/32"*

**SERVETTO  
CLOTHES LIFT**



Servetto appendiabiti  
estensibile in  
Bronzo-Alluminio  
Portata massima 10kg  
Estensibile da  
77 a 120 cm

*Bronze-Aluminum  
extensible clothes lift.  
Maximum load 10 kg  
Extensible from 30 5/16"  
to 47 1/4"*

**TUBO APPENDIABITI  
HANGING RAIL**

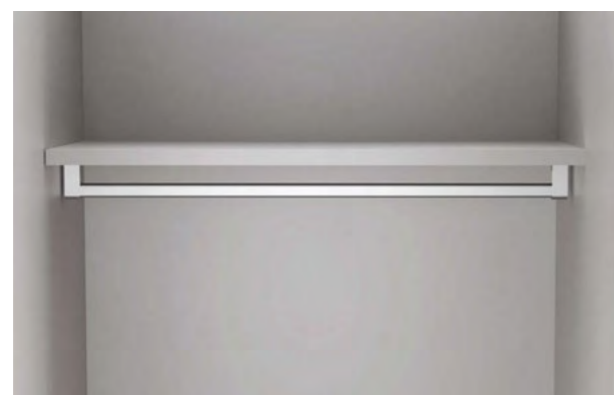

Tubo appendiabiti lineare  
in alluminio per moduli  
da 41.6 - 56.4 - 75 - 85.6  
95 - 115.2 cm

*Aluminum hanging rails  
Unit from 16 3/8"  
22 13/64" - 29 17/32"  
33 45/64" - 37 13/32"  
45 23/64"*

**TUBO APPENDIABITI  
QUADRO  
QUADRO HANGING  
RAIL**

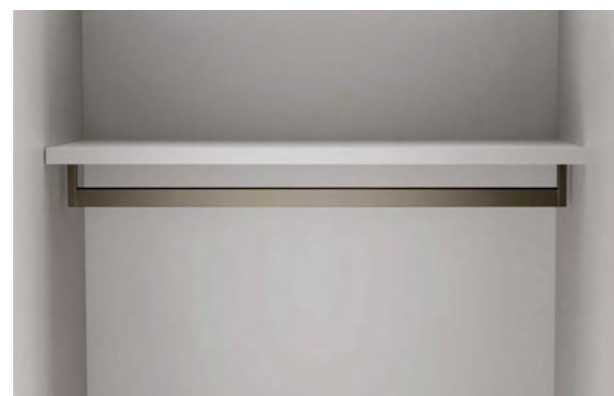

Tubo appendiabiti  
Quadro  
bronzo/alluminio.  
per moduli da 41.6 - 56.4  
75 - 85.6 - 95 - 115.2 cm

*Quadro  
bronzo/aluminum  
hanging rail.  
Unit from 16 3/8"  
22 13/64" - 29 17/32"  
33 45/64" - 37 13/32"  
45 23/64"*

**CASSETTONE**  
**HIGH DRAWER**



Per modulo da 41.6 - 56.4  
 75 - 85.6 - 95 - 115.2 cm  
 Profondità 42 cm  
 Altezza 24.2 cm  
 Frontale in finitura  
 nobilitato, laccato, con  
 vetro laccato, specchiato  
 o con stampa digitale.  
 Finitura interna cassetto  
 sempre nobilitato Trama  
 Tessuto.

*Unit 16 3/8" - 22 13/64"  
 29 17/32" - 33 45/64"  
 37 13/32" - 45 23/64"  
 Depth 16 17/32"  
 Height 9 17/32"  
 Front panel with melamine,  
 lacquered, with glass,  
 lacquered and mirrored  
 or with digital print.  
 Inner drawer finishes are  
 always Trama Tessuto  
 melamine.*

**CASSETTO**  
**DRAWER**



Per modulo da 41.6 - 56.4  
 75 - 85.6 - 95 - 115.2 cm  
 Profondità 42 cm  
 Altezza 24.2 cm  
 Frontale in finitura  
 nobilitato, laccato, con  
 vetro laccato, specchiato  
 o con stampa digitale.  
 Finitura interna cassetto  
 sempre nobilitato Trama  
 Tessuto. Guide cassetti  
 standard o estrazione totale  
 e apertura push-pull.

*Unit 16 3/8" - 22 13/64"  
 29 17/32" - 33 45/64"  
 37 13/32" - 45 23/64"  
 Depth 16 17/32"  
 Height 9 17/32"  
 Front panel with melamine,  
 lacquered, with glass,  
 lacquered and mirrored or  
 with digital print Inner drawer  
 finishes are always Trama  
 Tessuto melamine. With  
 standard or full extension  
 rails and push-pull opening.*

**RIPIANO ESTRAIBILE**  
**PULL-OUT SHELF**



Per modulo da 41.6 - 56.4  
 75 - 85.6 - 95 - 115.2 cm  
 Profondità 42 cm  
 Altezza 15.7 cm  
 Finitura interna e frontale  
 in nobilitato o laccato.

*Unit 16 3/8" - 22 13/64"  
 29 17/32" - 33 45/64"  
 37 13/32" - 45 23/64"  
 Depth 16 17/32"  
 Height 6 3/16"  
 Finish in melamine for  
 inner and external parts  
 in melamine or lacquered.*

**RIPIANO ESTRAIBILE**  
**CON FRONTALE**  
**IN VETRO**  
**GLASS PULL-OUT**  
**SHELF**

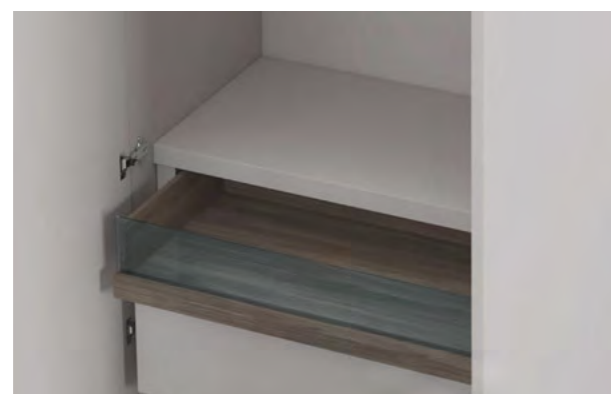

Per modulo da 41.6 - 56.4  
 75 - 85.6 - 95 - 115.2 cm  
 Profondità 42 cm  
 Altezza 15.7 cm  
 Finitura interna in  
 nobilitato o laccato  
 e frontale in vetro  
 extrachiaro.

*Unit 16 3/8" - 22 13/64"  
 29 17/32" - 33 45/64"  
 37 13/32" - 45 23/64"  
 Depth 16 17/32"  
 Height 6 3/16"  
 finish in melamine for  
 inner and external parts  
 and glass front.*



**CASSETTIERA INTERNA  
IN APPOGGIO  
FREE STANDING INNER  
CHEST OF DRAWERS**



Per modulo da 41.6 - 56.4  
75 - 85.6 - 95 - 115.2 cm  
Profondità 46.2 cm  
Altezza 18.5/10.7 cm

Unit 16 3/8" - 22 13/64"  
29 17/32" - 33 45/64"  
37 13/32" - 45 23/64"  
Depth 18 3/16"  
Height 7 9/32" - 4 7/32"

**CASSETTIERA  
INTERNA SOSPESA  
HANGING INNER  
CHEST OF DRAWERS**



Per modulo da 41.6 - 56.4  
75 - 85.6 - 95 - 115.2 cm  
Profondità 46.2 cm  
Altezza 18.5/59 cm  
Da 1 a 3 cassetti

Unit 16 3/8" - 22 13/64"  
29 17/32" - 33 45/64"  
37 13/32" - 45 23/64"  
Depth 18 3/16"  
Height 7 9/32" - 23 15/64"  
From 1 to 3 drawers

Di default con guide cassetti standard, o su richiesta guide a estrazione totale e apertura push-pull. In caso di inserimento di organizer la guida sarà di default ad estrazione totale. Struttura in finitura nobilitato o laccato Frontali in finitura nobilitato, laccato o stampa digitale. Il top

della cassettera può essere in legno sp. 4 cm o in vetro sp. 1 cm. È possibile applicare il vetro sp. 0,4 cm sul frontalino sp. 1.6 cm Con vetro, finiture vetro retrolaccato/specchiato/ con stampa digitale. È possibile inserire all'interno dei cassetti un organizer con finitura laccato.

By default with standard rails or on demand with full extension rails and push-pull opening. With organizer, full extension rails by default. Structure in melamine and lacquered finish. Front parts in melamine and lacquered finish or with digital print. Chest of drawer top can be

1 37/64" th. wood or 3/64" th. glass. It is possible to apply 5/32" glass to 5/8" wooden front panel By using glass, available finishes are backlacquered and mirrored glass or with digital print. It is possible to add the organizer in lacquered finish inside the drawer.

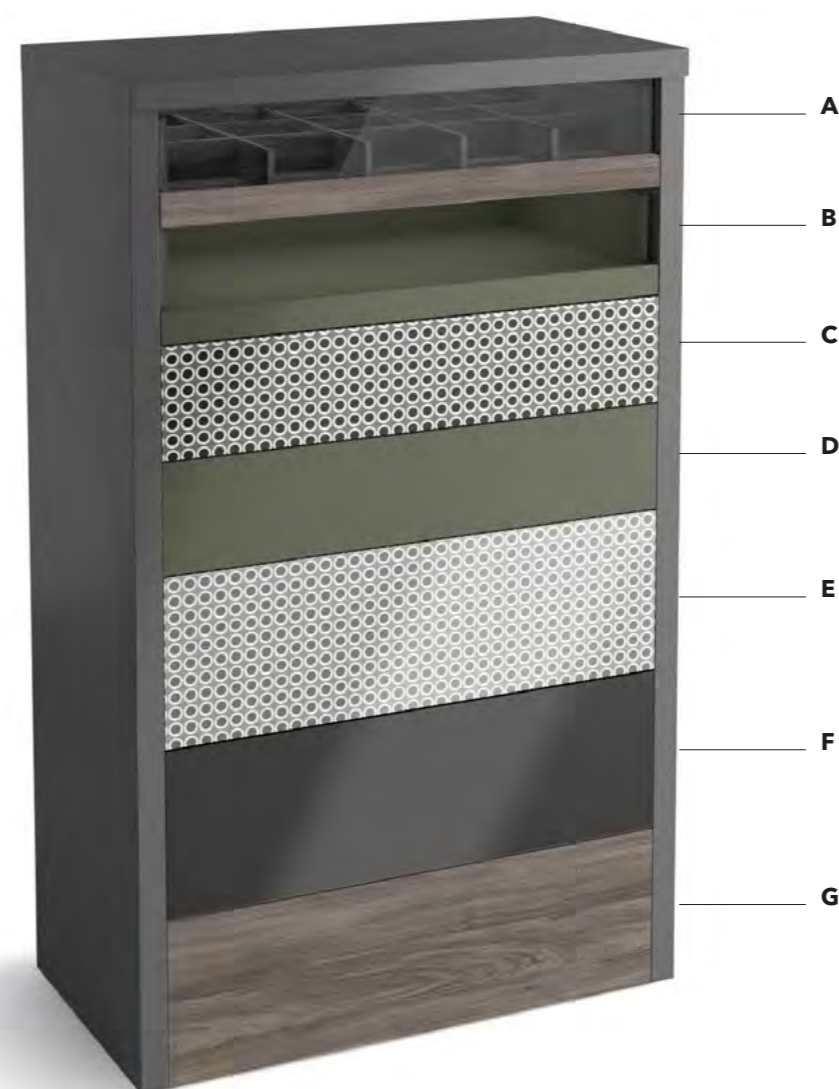

**A /**  
Ripiano estraibile in nobilitato con frontale in vetro extrachiaro e organizer  
Melamine finish pull-out shelf with extra-clear glass front and organizer

**B /**  
Ripiano estraibile laccato  
Lacquered finish pull-out shelf

**C /**  
Cassetto con frontale in nobilitato e stampa digitale  
Drawer with front in melamine finishes and digital print

**D /**  
Cassetto con frontale in laccato opaco  
Drawer with front in matt lacquered

**E /**  
Cassettone con frontale in vetro e stampa digitale  
High drawer with glass front and digital print

**F /**  
Cassettone con frontale in vetro specchiato bronzo  
High drawer with mirrored glass front

**G /**  
Cassettone in nobilitato  
High drawer in melamine

È possibile realizzare cassettiere interne personalizzate utilizzando i singoli componenti. Ciascun cassetto, nella stessa struttura, può avere finiture o tipologie diverse (es. cassetto basso/ cassettone, frontalino legno+vetro, ripiano estraibile con o senza frontalino in vetro etc.)

It is possible to produce custom inner chest of drawers by using specific single components. In the same structure it is possible to introduce different kinds of drawers in different finishes (i.e. drawer, high drawer, wood+glass front part, pull-out shelf with or without glass front etc.)

**RASTER PER ARMADI**  
**RASTER FOR WARDROBE**



Raster per armadi con 1 divisore verticale in finiture laccato e nobilitato. Per modulo da 56.4 - 75 - 85.6 - 95 cm Profondità 45.2 cm Altezza 32 - 48 - 64 cm Spessori 1.2 cm

*Raster for wardrobes with 1 vertical partition in melamine and lacquered finish. For units from 22 13/64 33 45/64" Depth 17 51/64" Height 12 19/32" 18 57/64"- 25 13/64" Thickness 15/32"*

**SPECCHIO INTERNO ANTA**  
**INTERNAL MIRROR DOOR**



Specchio interno anta Larghezza 32 cm Altezza 140 - 180 cm Spessore 0.4 cm

*Internal mirror door Width 12 19/32" Height 55 1/8"- 70 55/64" Thickness 5/32"*

**RASTER PER ARMADI CON 2 DIVISORI**  
**RASTER FOR WARDROBE WITH 2 PARTITIONS**



Raster per armadi con 2 divisori verticali in finiture laccato e nobilitato. Per modulo da 85.6 - 95 - 115.2 cm Profondità 45.2 cm Altezza 32 - 48 - 64 cm Spessori 1.2 cm Nel modulo da 85.6 cm è possibile inserire un vano più grande centrale per alloggiare scatole.

*Raster for wardrobes with 2 vertical partitions in melamine and lacquered finish. For units from 33 45/64" 37 13/32" - 45 23/64" Depth 17 51/64" Height 12 19/32" 18 57/64"- 25 13/64" Thickness 15/32" In 33 45/64" unit it is possible to include a middle bigger unit to insert boxes.*

**SPECCHIO ESTRAIBILE INTERNO**  
**EXTENDABLE INTERNAL MIRROR**



Specchio estraibile interno Larghezza 45 cm Altezza 140 cm Spessore (a riposo) 4,5 cm Per armadi scorrevoli, open o armadi con anta battente singola, lato opposto alla cerniera.

*Extendable internal mirror Width 17 23/32" Height 55 1/8" Thickness 1 49/64" (stored) For sliding, open or hinged wardrobes with one single door, where there are no hinges.*

**RASTER PER ARMADI CON 3 DIVISORI**  
**RASTER FOR WARDROBE WITH 3 PARTITIONS**



Raster per armadi con 3 divisori verticali in finiture laccato e nobilitato. Per modulo da 115.2 cm Profondità 45.2 cm Altezza 32-48-64 cm Spessori 1.2 cm

*Raster for wardrobes with 3 vertical partitions in melamine and lacquered finish. For units from 45 23/64" Depth 17 51/64" Height 12 19/32" 18 57/64"- 25 13/64" Thickness 15/32"*

**DIVISORI PER CASSETTO**  
**ORGANIZER**



Divisori per cassetto e cassettoni. Finitura laccata.

*Organizer for drawer and high drawer. Lacquered finish.*

**INTERRUTTORI CON FILO  
WIRE SWITCHES**

/ **ATTREZZATURE INTERNE  
INTERNAL EQUIPMENT** ILLUMINAZIONE  
LIGHTING

KYA



Luce led inclinata ad incasso con finitura color alluminio o bronzo, specifica per cappelli, ripiani armadi, vani a giorno ed elementi Window. Accensione tramite sensore di movimento, telecomando o interruttore a sfioro. 3000°K.

*Inclined embedded led light with aluminum or bronze colour finish, specific for wardrobe top, shelves, open unit and Window unit. Turn on by sensor, remote control or touch switch. 3000° K.*

INT7M



Interruttore a sensore di movimento per luce led. Esterno o incassato, **installazione e posizionamento a cura del cliente**. Colore alluminio.

*Sensor switch for led light. External or embedded, **installation and positioning by customer**. Aluminum colour.*

INT7A



Interruttore retro anta. Esterno o incassato, **installazione e posizionamento a cura del cliente**. Colore alluminio.

*Back-door switch for led light. External or embedded, **installation and positioning by customer**. Aluminum colour.*

INT7S



Interruttore a sfioro per luce led. Esterno o incassato, **installazione e posizionamento a cura del cliente**. Colore alluminio.

*Touch switch for led light. External or embedded, **installation and positioning by customer**. Aluminum colour.*

KW06



Interruttore retro anta incassato **pre-montato da Tumidei**. Colore nero.

*Embedded back-door switch. **Pre-assembled by Tumidei**. Black finish.*

KW08



Interruttore esterno o incassato **pre-montato da Tumidei**, programmabile per versione retro-anta oppure interruttore on-off. Colore Bianco.

*External or embedded switch. **Pre-assembled by Tumidei**. Programmable for back-door sensor or on-off switch. White colour.*

INT7R



Kit telecomando e interruttore per luce led a 4 canali, dimmerabile. Colore nero.

*Kit with remote control and 4 channel dimmer switch for led light.*

KYN



Luce led ad incasso specifica per mensole e ripiani, Window, vani a giorno e cabine Spring Ludo e Mati. Accensione tramite sensore di movimento, telecomando o interruttore a sfioro. 3000°K.

*Embedded led light specific for shelves. Window unit and walk-in closet Spring, Ludo and Mati. Turn on by sensor, remote control or touch switch. 3000° K.*

KZB



Luce led ad incasso in silicone per fianco, esclusivamente per fianchi spessore 2- 2.8 o 4 cm, altezza fianchi. Accensione tramite sensore di movimento, telecomando o interruttore a sfioro 3000°K.

*Embedded silicon led light, for sides 25/32" 1 7/64"-1 37/64", th. exclusively. Turn on by sensor, remote control or touch switch. 3000° K.*

KYL



Luce led a incasso per ripiani telaio in vetro o legno cabina Mati. Accensione manuale o wireless.

*Embedded led light for Mati walk-in closet glass framed or wooden shelves. Manual or wireless switch.*

L'IMPIANTO ELETTRICO FORNITO È CONFORME ALLE PRINCIPALI NORMATIVE INTERNAZIONALI. (VERIFICARE L'ASSORBIMENTO DELLE LUCI LED PER POTER SCEGLIERE IL TRASFORMATORE ADEGUATO. CONSULTARE IL LISTINO WARDROBE)

THE SUPPLIED ELECTRICAL SYSTEM IS IN COMPLIANCE WITH THE MAIN INTERNATIONAL NORMS. (CHECK THE ABSORPTION OF THE LED LIGHTS IN ORDER TO CHOOSE THE SUITABLE TRANSFORMER. PLEASE REFER TO THE WARDROBE PRICE LIST)

**INTERRUTTORI SENZA FILO  
WIRELESS SWITCHES**

KW12



Sensore di presenza wireless incassato, alimentato con batteria al litio. Colore alluminio

*Embedded wireless presence sensor. Powered by lithium battery. Aluminum colour.*

KW11



Sensore on-off di prossimità wireless posizionabile dal cliente, Alimentato con batteria al litio Colore alluminio

*Wireless proximity sensor on-off positionable by the customer. Powered by lithium battery. Aluminum colour.*

KW16



Telecomando mono-canale wireless, dimmerabile, alimentato con batteria litio. Colore alluminio

*Dimmable wireless 1 channel remote control, dimmable, powered by lithium battery. Aluminum colour.*

KW18



Telecomando interruttore dimmerabile a 3 canali per luci wireless. Colore bianco.

*3 channel dimmable switch remote control for wireless lights. White colour.*

**N.B.** GLI ACCESSORI "INT" **NON** POSSONO ESSERE COMBINATI CON GLI ACCESSORI "KW".

**N.B.** INT ACCESSORIES **CANNOT** BE USED IN COMBINATION WITH KW ACCESSORIES "KW".



È inoltre possibile gestire accensioni tramite **Bluetooth KW3** con apposita app dedicata per smartphone oppure con **wi-fi KW4** tramite apposita app dedicata per smartphone o con i dispositivi a controllo vocale Amazon Echo e Google Home.

*It is also possible to manage switches via **Bluetooth KW3** with a specific app for smartphones or either with **wi-fi KW4** through a specific wi-fi app or with Amazon Echo and Google Home voice control devices.*

**FONDO PER CASSETTO  
DRAWER BOTTOM**



Kit 2 pezzi, finitura simil pelle marrone moka.  
Per cassettiere interne armadi, cabina Mati, Ludo e Isola  
profondità 38.8  
larghezza 44.3 - 62.9 - 73.5  
82.9 - 103.1

Per cassetti esterni armadi battenti  
profondità 48.8 cm  
larghezza 52.5 - 81.7  
111.3 cm

*2 pieces, brown moka synthetic leather finish  
For hinged wardrobe inner chests of drawers, Mati, Ludo walk-in closet and Isola.  
Depth 15 9/32"  
Width 17 7/16" - 24 49/64"  
28 15/16" - 32 41/64"  
40 19/32"  
For hinged wardrobes external drawers depth  
19 7/32"  
Width 20 43/64" - 32 11/64"  
43 13/16"*

**CONTENITORE EXC52  
BOX EXC52**



Contenitore dotato di linguetta simil pelle, kit 3 pezzi  
finiture tessuto - grigio Tasmania, grigio lino, brown  
Profondità 46.5 cm  
Larghezza 39 cm  
Altezza 25.5 cm  
\*con coperchio opzionale\*

*Box with synthetic leather tab, 3 pieces  
Fabric finishes: grigio Tasmania, grigio lino, brown  
Depth 18 5/16"  
Width 15 23/64"  
Height 10 3/64"  
\*with optional cover\**

**FONDO PER CASSETTO A 3 SCOMPARTI  
3 COMPARTMENT DRAWER BOTTOM**



Kit 1 pezzo finitura simil pelle marrone moka per cassettiere interne armadi, cabina Mati, Ludo e Isola  
profondità 38.8  
larghezza 44.3 - 62.9 - 73.5  
82.9 - 103.1

Per cassetti esterni armadi battenti  
profondità 48.8 cm  
Larghezza 52.5 - 81.7  
111.3 cm

*1 piece, brown moka synthetic leather finish  
For wardrobe inner chests of drawers, Mati, Ludo walk-in closet and Isola.  
depth 15 9/32"  
width 17 7/16" - 24 49/64"  
28 15/16" - 32 41/64"  
40 19/32"*

*For hinged columns external drawers depth 19 7/32"  
Width 20 43/64" - 32 11/64"  
43 13/16"*

**CONTENITORE EXC51  
BOX EXC51**



Contenitore dotato di linguetta simil pelle, kit 3 pezzi  
finiture tessuto - grigio Tasmania, grigio lino, brown  
Profondità 46.5 cm  
Larghezza 39 cm  
Altezza 12 cm  
\* a richiesta con coperchio\*

*Box with synthetic leather tab, 3 pieces  
Fabric finishes: grigio Tasmania, grigio lino, brown  
Depth 18 5/16"  
Width 15 23/64"  
Height 4 23/32"  
\*with cover on demand\**

**VASSOIO PORTAOROLOGI  
WATCH-HOLDER TRAY**



kit 2 pezzi finitura simil pelle marrone moka  
Profondità 36 cm  
Larghezza 15 cm  
Altezza 5 cm  
Profondità 41 cm  
Larghezza 15 cm  
Altezza 5 cm

*2 pieces, brown moka synthetic leather finish  
Depth 14 11/64"  
Width 5 29/32"  
Height 1 31/32"  
Depth 16 9/64"  
Width 5 29/32"  
Height 1 31/32"*

**CONTENITORE EXC42  
BOX EXC42**



Contenitore dotato di linguetta simil pelle, kit 3 pezzi  
finiture tessuto - grigio Tasmania, grigio lino, brown  
Profondità 40 cm (per raster)  
Larghezza 35 cm  
Altezza 12.5 cm

*Box with synthetic leather tab, 3 pieces  
Fabric finishes: grigio Tasmania, grigio lino, brown  
Depth 15 3/4"  
(for RASTER)  
Width 13 25/32"  
Height 4 59/64"*

**VASSOIO MULTIUSO A 3 SCOMPARTI  
MULTIFUNCTIONAL 3 COMPARTMENT TRAY**



kit 2 pezzi finitura simil pelle marrone moka  
Profondità 36 cm  
Larghezza 15 cm  
Altezza 5 cm

Profondità 41 cm  
Larghezza 15 cm  
Altezza 5 cm

*2 pieces, brown moka synthetic leather finish  
Depth 14 11/64"  
Width 5 29/32"  
Height 1 31/32"*

*Depth 16 9/64"  
Width 5 29/32"  
Height 1 31/32"*

**CONTENITORE EXC41  
BOX EXC41**



Contenitore dotato di linguetta simil pelle, kit 3 pezzi, finiture tessuto grigio Tasmania, grigio lino, brown  
Profondità 40 cm (per RASTER)  
Larghezza 35 cm  
Altezza 8 cm

*Box with synthetic leather tab, 3 pieces, Fabric finishes: grigio Tasmania, grigio lino, brown  
Depth 15 3/4"  
(For RASTER)  
Width 13 25/32"  
Height 3 5/32"*

**ANELLO PORTA  
SCIARPE E FOULARD  
SCARF AND FOULARD  
RACK RING**



kit 2 pezzi  
Materiale anello - faggio  
Finitura anello - wenge  
Materiale gancio - Zamak  
verniciata a polvere  
epossidica  
Finitura gancio  
Marrone metal grey  
Larghezza 15 cm  
Altezza 24.5 cm

2 pieces  
Ring material - Beech  
Ring finish - Wenge  
Hook material - Zamak  
painted with epoxy powder  
Hook finish  
Brown metal grey  
Width 5 29/32"  
Height 9 41/64"

**GRUCCIA PORTA  
PANTALONI  
TROUSERS RACK**



kit 4 pezzi  
Materiale gruccia - faggio  
Finitura gruccia - wenge  
Materiale gancio - Zamak  
verniciata a polvere  
epossidica  
Finitura gancio  
Marrone metal grey  
Possibilità di  
personalizzazione con  
logo Tumidei logo  
laserizzato  
(minimo kit 20 pezzi)  
Larghezza 39 cm  
Altezza 17 cm

4 pieces  
Hanger material - Beech  
Hanger finish - Wenge  
Hook material - Zamak  
painted with epoxy  
powder  
Hook finish  
Brown metal grey  
It is possible to customize  
with Tumidei laser logo  
(20 pieces minimum)  
Width 15 23/64"  
Height 6 11/16"

**GRUCCIA SPALLA CON  
ASTA PORTA PANTALONI  
SHOULDER HANGER  
WITH TROUSERS RACK  
ROD**



kit 4 pezzi  
Materiale gruccia - faggio  
Finitura gruccia - wenge  
Materiale gancio - Zamak  
verniciata a polvere  
epossidica  
Finitura gancio  
Marrone metal grey  
Possibilità di  
personalizzazione con  
logo Tumidei logo  
laserizzato  
(minimo kit 20 pezzi)  
Larghezza 45 cm  
Altezza 25.7 cm

4 pieces  
Hanger material - Beech  
Hanger finish - Wenge  
Hook material - Zamak  
painted with epoxy  
powder  
Hook finish  
Brown metal grey  
It is possible to customize  
with Tumidei laser logo  
(20 pieces minimum)  
Width 17 23/32"  
Height 10 1/8"

**ASTA PORTA CRAVATTE  
CON SUPPORTI IN PELLE  
TIES HANGER ROD WITH  
LEATHER SUPPORTS**



**ASTA PRENDIABITI  
CLOTHES GRABBER ROD**



**/ ACCESSORI  
ACCESSORIES**

kit 2 pezzi  
Materiale asta - faggio  
Finitura asta - wenge  
Materiale gancio - Zamak  
verniciata a polvere  
epossidica  
Finitura gancio  
Marrone metal grey  
Altezza 86.5 cm

2 pieces  
Rod material - Beech  
Rod finish - Wenge  
Hook material - Zamak  
painted with epoxy  
powder  
Hook finish  
Brown metal grey  
Height 34 1/16"

kit 1 pezzi  
Materiale asta - faggio  
Finitura asta - wenge  
Materiale gancio - Zamak  
verniciata a polvere  
epossidica  
Finitura gancio  
Marrone metal grey  
Altezza 97 cm

1 piece  
Rod material - Beech  
Rod finish - Wenge  
Hook material - Zamak  
painted with epoxy  
powder  
Hook finish  
Brown metal grey  
Height 38 3/16"



/ **SISTEMA AIR CLEANER**  
**AIR CLEANER SYSTEM**

Dispositivo per il trattamento e purificazione dell'aria all'interno di vani chiusi. Composto da lampada led UVA e filtro, riduce gli agenti nocivi come batteri, muffe e sostanze allergeniche.

*Air purifying device inside closed sections.  
Composed by UVA LED lamp and filter, it reduces pests such as bacterias, mold and allergenic substances.*

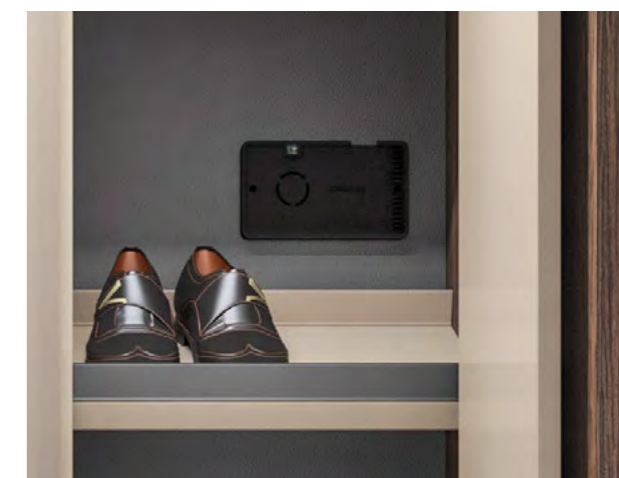

Larghezza 17 cm  
Altezza 10 cm  
Profondità 3,8 cm

*Width 6 11/16"  
Height 3 15/16"  
Depth 1 1/2"*





/ CABINA ARMADIO  
CABINET

MATI  
MATI

Capiente, funzionale e componibile, le cabine armadio Tumidei possono essere attrezzate con moduli angolari, luci led retro ripiani, cassetti in vetro fumé, tubi appendiabiti e una vasta gamma di accessori.

Cabina Mati disponibile solo con pannelli e cremagliere in finitura bronzo che, posizionate sul retro, donano un risultato visivamente leggero e pulito. I pannelli possono avere diverse finiture: nobilitato, laccato, essenza e vetro laccato, specchiato o con stampa digitale. Lo stesso pannello può essere diviso orizzontalmente così da ottenere due finiture diverse sulla stessa pannellatura.

Sui ripiani possono essere incassate luci LED anche wireless, ciò permette di poterli spostare a piacimento lungo tutto il pannello.

*Spacious, functional and modular, the Tumidei walk-in closet can be equipped with corner modules, LED lights on the back of the shelves, smoked glass drawers, clothes hangers and a wide range of accessories.*

*Mati Walk-in closet available only with panels and racks in bronze finish, which, being positioned on the back, give light and cleanliness to the final result.*

*The panels can have different finishes, such as melamine, lacquered, wood and lacquered glass, mirrored glass or with digital print.*

*The same panel can be divided horizontally in order to obtain two different finishes on the same paneling.*

*LED lights can also be recessed on the shelves, even wireless, which allows you to move them along the whole panel.*

**ISOLA  
ISLAND**

ISOLA è una sistema freestanding pensato per l'ambiente notte, in grado di inserirsi in ogni spazio progettuale.

*ISOLA is a freestanding system conceived for the sleeping area, suitable for any project space.*



**N.B.** PROFONDITÀ INTERNA 33,4 E 44,4 cm  
**N.B.** INTERNAL DEPTH 13 5/32" AND 17 31/64"

⊛ **SPESSORE** 4 cm  
**THICKNESS** 1 9/16"

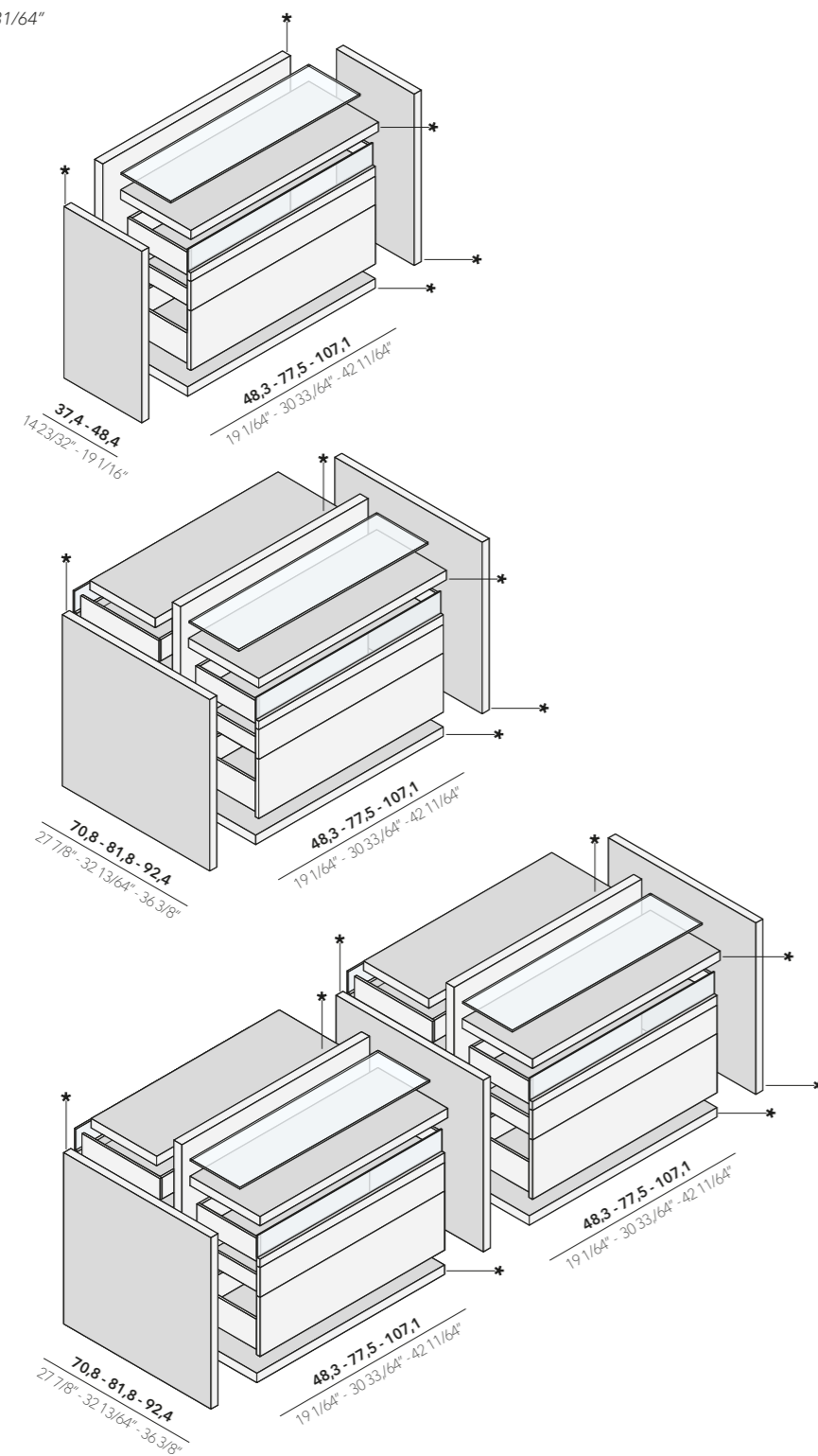

Un'organizzazione voluta degli interni, dove funzionalità e stile personale coincidono. Una soluzione d'arredo dalle linee basiche, arricchita da elementi di pregio, che reinterpreta gli spazi della camera da letto. La particolarità del sistema Isola,

è nell'estrema personalizzazione dei top e dei frontali cassetto, disponibili in tutte le finiture Vetro della collezione Tumidei.

*A designed organization of the internal accessories where functionality and personal style correspond. A furnishing solution, with basic lines, enhanced by precious elements, which is going to reimagine the bedroom spaces. The feature of Isola system is the*

*extreme personalization of tops and front drawers available in all the Tumidei Vetro collection finishes.*

**TIPOLOGIE DI TOP  
TOP EXAMPLES**

Senza top con piano in vetro sp. 0,4 cm opzionale in finitura retrolaccato o con stampa digitale.

*Without top with optional 5/32" cm th glass in back-lacquered or digital print finishes.*



Top in vetro allineato ai fianchi, prof 33,2 cm

*Glass top flushed with sides 13 5/64" depth*

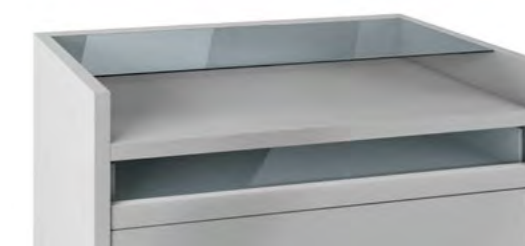

Top in vetro allineato ai fianchi, copertura totale

*Glass top flushed with sides total covering*

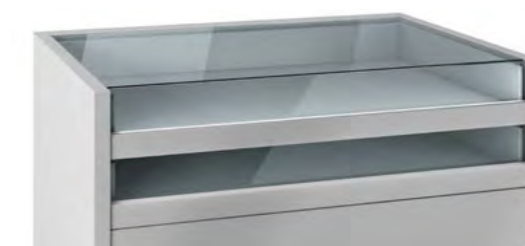

Top in legno, sp 4 cm sovrapposto ai fianchi profondità 37,4 cm

*Wooden top overlapping sides th. 14 23/32" depth*



Top in legno, sp 4 cm sovrapposto ai fianchi copertura totale

*Wooden top overlapping sides total covering th. 1 37/64"*



TIPOLOGIE DI MODULI **SINGOLI A** / PROFONDITÀ 37,4 cm  
**SINGLE ITEMS TYPE A** / DEPTH 14 23/32"

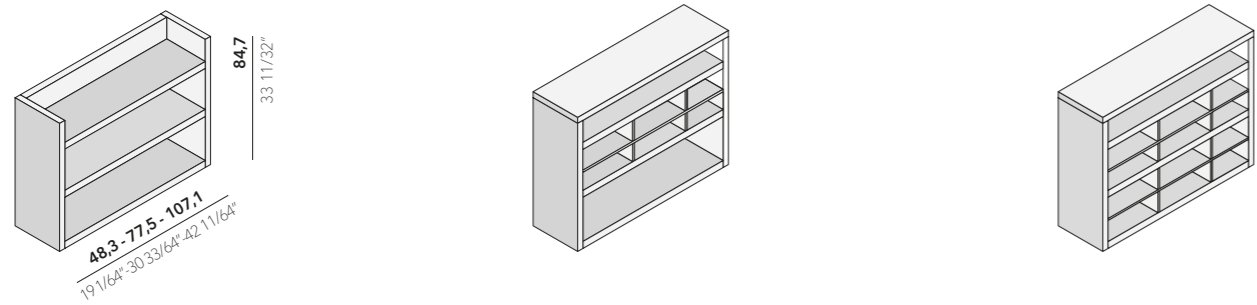

ALCUNE TIPOLOGIE DI MODULI **SINGOLI B** / PROFONDITÀ 48,4 cm  
**SINGLE ITEMS TYPE B** / DEPTH 19 1/16"

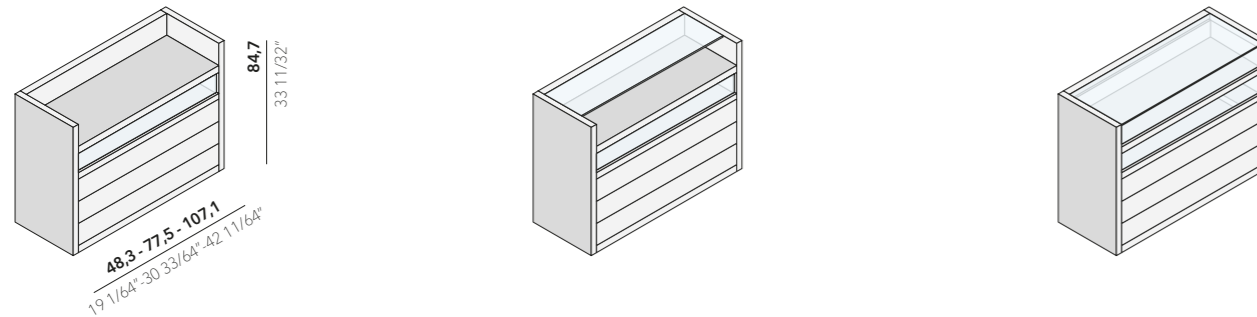

TIPOLOGIE MODULI **ACPOSTATI A+A** / PROFONDITÀ 37,4 cm  
**DOUBLE ITEMS TYPE A+A** / DEPTH 14 23/32"

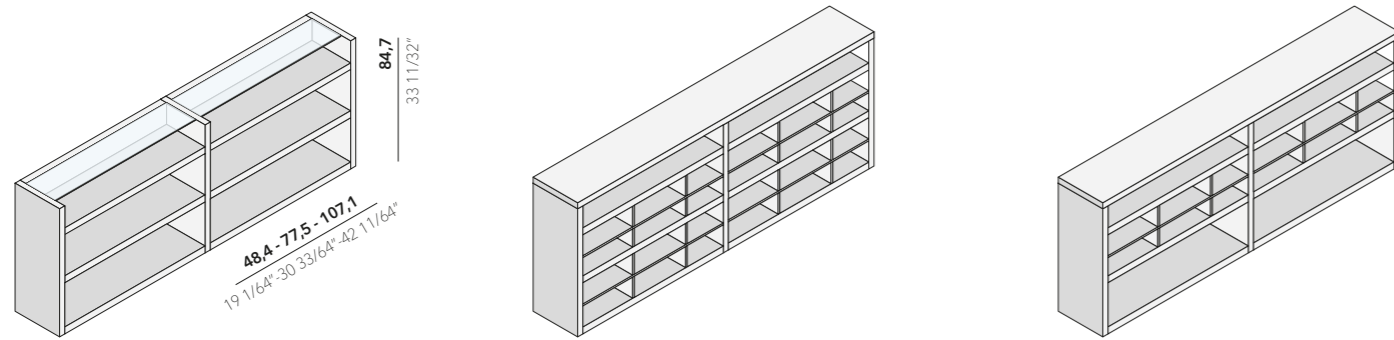

TIPOLOGIE MODULI **ACPOSTATI B+B** / PROFONDITÀ 48,4 cm  
**DOUBLE ITEMS TYPE B+B** / DEPTH 19 1/16"

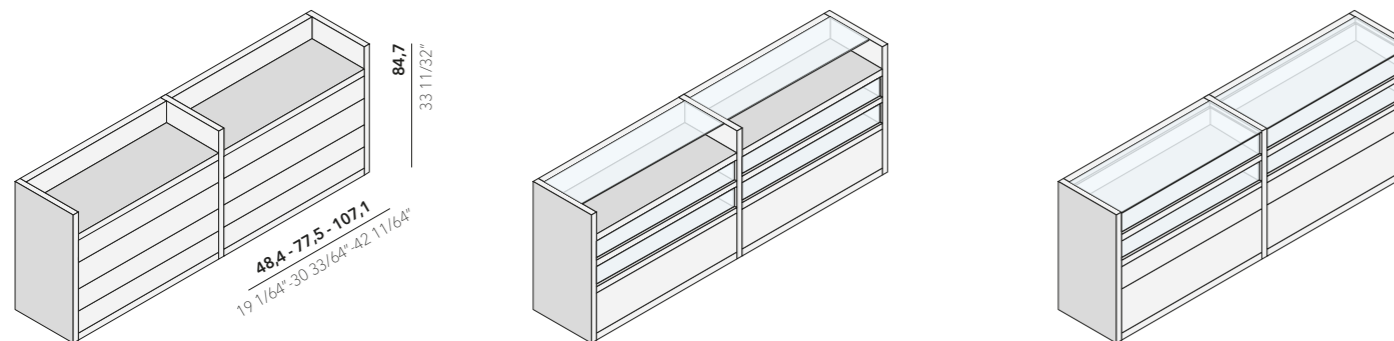

TIPOLOGIE MODULI **ACPOSTATI CON VERSO CONTRARIO A+A** / PROFONDITÀ 37,4 cm  
**JOINED MODULES WITH OPPOSITE DIRECTION TYPE A+A** / DEPTH 14 23/32"

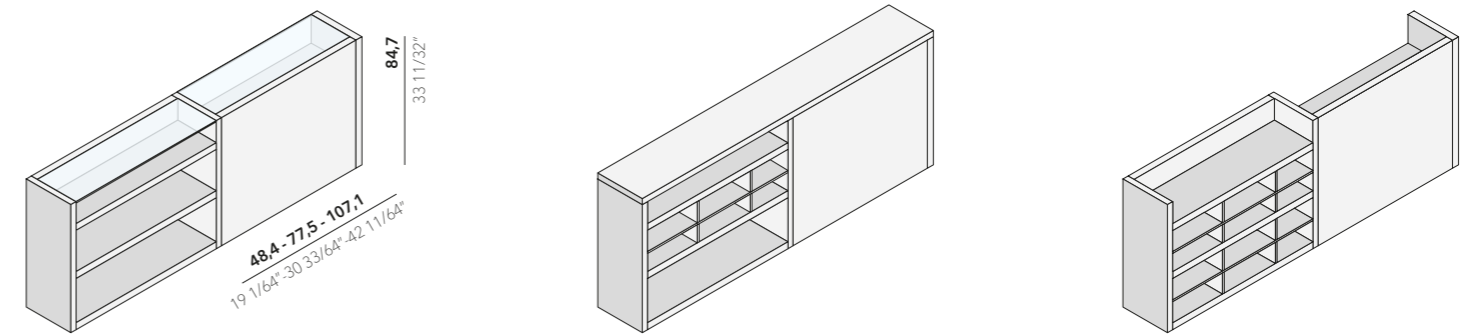

TIPOLOGIE MODULI **ACPOSTATI CON VERSO CONTRARIO B+B** / PROFONDITÀ 48,4 cm  
**JOINED MODULES WITH OPPOSITE DIRECTION TYPE B+B** / DEPTH 19 1/16"

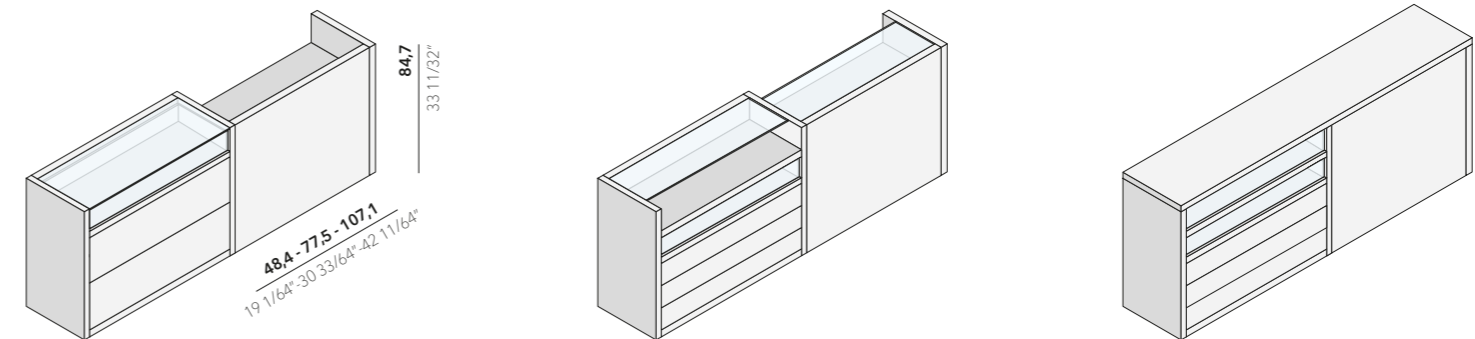

TIPOLOGIE MODULI **CONTRAPPOSTI BIFACCIALI A+A / B+A / B+B** PROFONDITÀ 70.8 - 81.8 - 92.4 cm  
**DOUBLE SIDED MODULES TYPE A+A / B+A / B+B** DEPTH 27 7/8" - 32 13/64" - 36 3/8"

**A+A**  
P 70.8 cm  
D 27 7/8"

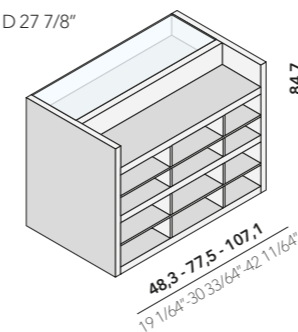

**B+A**  
P 81.8 cm  
D 32 13/64"

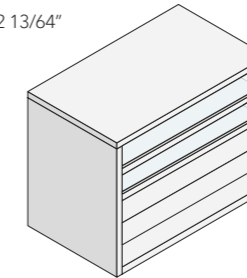

**B+B**  
P 92.4 cm  
D 36 3/8"

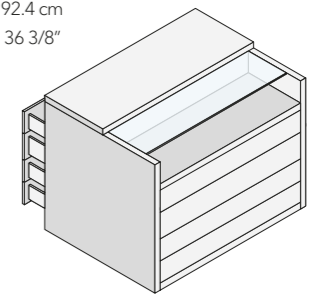

TIPOLOGIE MODULI **ACPOSTATI E CONTRAPPOSTI BIFACCIALI A+A / B+A / B+B** PROFONDITÀ 70.8 - 81.8 - 92.4 cm  
**JOINED DOUBLE SIDED MODULES TYPE A+A / B+A / B+B** DEPTH 27 7/8" - 32 13/64" - 36 3/8"

**A+A**  
P 70.8 cm  
D 27 7/8"

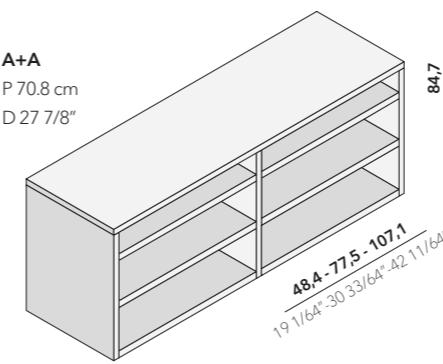

**B+A**  
P 81.8 cm  
D 32 13/64"

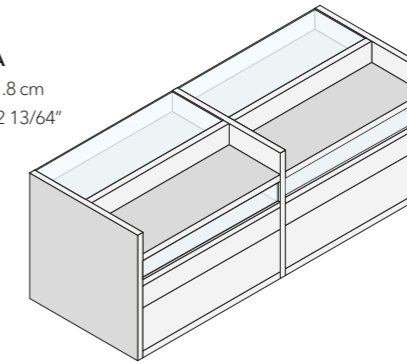

**B+B**  
P 92.4 cm  
D 36 3/8"

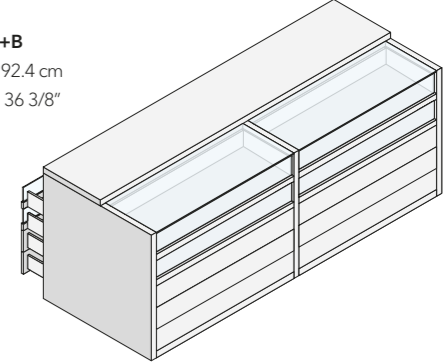

**TIPOLOGIE DI SISTEMI LETTO**  
**BED SYSTEM TYPE**

**RING**

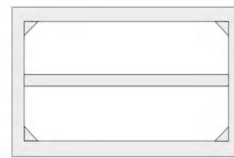

Rete a doghe in appoggio inclusa.  
Predisposizione per rete in appoggio su angolari e palo centrale longitudinale. Piano di appoggio rete regolabile su 2 livelli incassati.  
H 6 cm e h 12.5 cm rispetto al bordo del giroletto.  
La barra longitudinale viene fornita solo oltre i 140 cm. Selezionabile solo per giroletto h 27cm.

*Bedframe included. Angles and central bars are preset for a bedstead. The bearing surface is adjustable at 2 heights. H 2 23/64" and 49 7/32" referring to the bedframe. Standard longitudinal board is provided from 55 1/8" version upwards. On bed-ring h 10 5/8" only.*



**BOX**

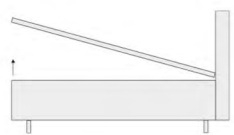

Include rete ortopedica a doghe con doppio palo di sostegno centrale con 14 doghe in betulla da 6.5 cm. Doppio palo fornito solo nelle versioni 160 e 180 cm.  
Coprirete in tessuto opzionale.

*Including an orthopedic staves bedframe with double central support and 14 2 9/16" birchen staves. Double central bars provided only in 62 63/64" and 70 55/64" versions. Optional bedframe fabric covering.*



**PARALLEL BOX**

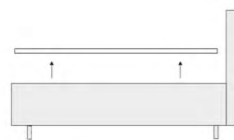

Include rete ortopedica a doghe con doppio palo di sostegno centrale con 14 doghe in betulla da 6.5 cm. Doppio palo fornito solo nelle versioni 160 e 180 cm. Altezza fascia contenitore 27 cm.  
Sistema di apertura comfort a rete parallela.  
Coprirete in tessuto opzionale.

*Including an orthopedic staves bedframe with double central support and 14 2 9/16" birchen staves. Double central bars provided only in 62 63/64" and 70 55/64" versions. External height of the storage area 10 5/8". Comfort parallel frame opening system. Optional bedframe fabric covering.*



**FIX**

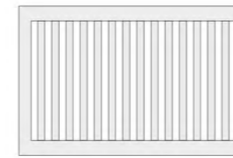

Include rete ortopedica strutturale con palo di sostegno centrale con 14 doghe da 6.5 cm in betulla.

*Including a structural orthopedic with central support and 14 birchen staves. The bedframe is also the main frame of the bed.*



**SECRET BOX**

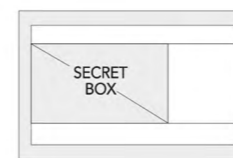

Con il giroletto h 17 cm è possibile inserire Secret Box un contenitore funzionale dotato di scorrimento, per agevolare l'utilizzo e renderlo invisibile. Include rete ortopedica a doghe con doppio palo di sostegno centrale con 14 doghe in betulla da 6.5 cm. Doppio palo fornito solo nelle versioni 160 e 180 cm.

*With h 6 11/16" sommier, it is possible to include Secret Box, which is a functional sliding box, to facilitate use and make it invisible. Including an orthopedic staves bedframe with double central support and 14 2 9/16" birchen staves. Double central bars provided only in 62 63/64" and 70 55/64" versions.*



Carter di compensazione opzionali  
Optional adjustment carter

**REMOVABLE**

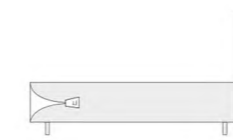

Imbottiti interamente sfoderabili.

*Upholstered bed completely removable.*

Coprirete in tessuto (opzionale)  
Bedframe fabric covering (optional)



LETTO PLAN  
PLAN BED

Design Simone Cagnazzo

Grazie alla sua componibilità, il sistema letto Plan, risolve con uno stile originale una molteplicità di situazioni, in ambiti contract o domestici. Il giroletto può essere imbottito o in legno, anche con piede centrale in metallo che insieme all'illuminazione a Led,

inserita nelle mensole in vetro, crea una sensazione di magica leggerezza. È caratterizzato da una rigorosa geometria che si coniuga perfettamente con la funzionalità ed eleganza degli elementi laterali in nicchia.

*Thanks to its modularity, the Plan bed systems solves a variety of situations with an original style, in contract or domestic settings. The bed base can be wooden or upholstered, even with a central metal foot which, together with LED lighting, recessed in*

*the glass shelves, it infuses a feeling of magical lightness. It's characterized by a rigorous geometry which perfectly combines with the functionality and elegance of its side niche items.*

LETTO PLAN H 12  
PLAN BED H 12

Design Simone Cagnazzo

Con giroletto legno h 12 cm disponibile solo in finitura nobilitato, laccato o essenza, con piedi in metallo nero e con rete ortopedica a doghe in appoggio.

*With 4 23/32" h wooden bedframe available in melamine, lacquered or wood finish, with metal feet and with orthopedic standing staves bedframe.*



MODULO SX/DX  
R/L ITEM

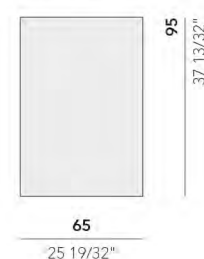

MODULO SX/DX CON CASSETTO  
R/L ITEM WITH DRAWER

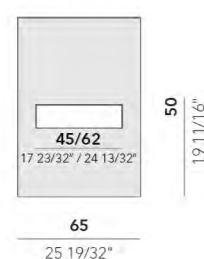

MODULO NICCHIA CON MENSOLA  
ITEM WITH NICHE AND SHELF

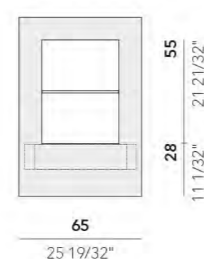

MODULO NICCHIA CON MENSOLA  
ITEM WITH NICHE AND SHELF

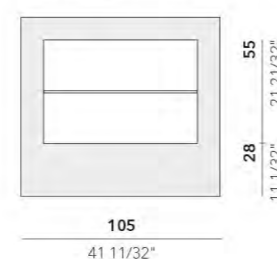

Finitura modulo liscio in nobilitato, laccato e essenza.

*Item in melamine, lacquered and wood finish.*

Finitura modulo in nobilitato, laccato, essenza e cassetto disponibile solo in finitura laccato e essenza. Cassetto L 45/62 cm.

*Item in melamine, lacquered or Wood with drawer available in lacquered and wood finish only. Drawer W 17 23/32" and 24 13/32".*

Finitura modulo con nicchia in nobilitato, laccato, essenza, fondo nicchia disponibile anche in vetro laccato o con stampa digitale (tessuto, legni, pietre e cementi). Ripiano in legno o vetro con luce. Presa Schuko e due usb opzionali. Cassetto opzionale.

*Item with niche in melamine, lacquered and wood finish, niche bottom available in lacquered or digital print glass. Wooden shelf or glass shelf with light. Schuko socket and USB optional chargers. Optional drawer.*

Finitura modulo con nicchia in nobilitato, laccato, essenza, fondo nicchia disponibile anche in vetro laccato o con stampa digitale (tessuto, legni, pietre e cementi). Ripiano in legno o vetro con luce. Presa Schuko e due usb opzionali.

*Item with niche in melamine, lacquered and wood finish, niche bottom available in lacquered or digital print glass. Wooden shelf or glass shelf with light. Schuko socket and USB optional chargers.*

TESTATA IMBOTTITA TESSILE  
UPHOLSTERED HEADBOARD

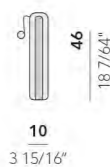
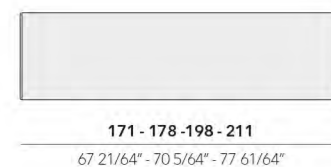
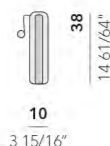
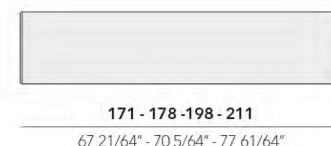

Testate in tessuto sfoderabile per letto Plan opzionali, l'altezza della testata va scelta a seconda del giroletto o materasso da inserire.

*Optional headboards in removable fabric for Plan bed, the height of the headboard must be chosen according to the bed frame or mattress to be inserted.*

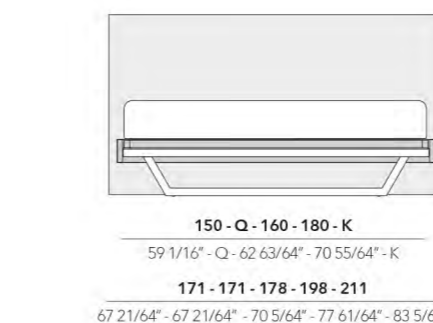

materassi  
mattresses

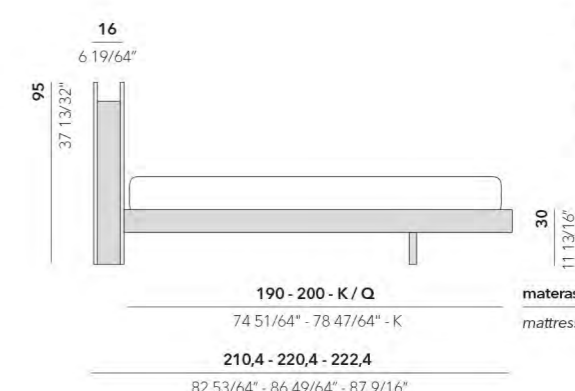

materassi  
mattresses

LEGGENDA:

Q: QUEEN 153 X 203

K: KING 193 X 203

LEGGENDA:

Q: QUEEN 60 15/64" X 79 59/64"

K: KING 75 63/64" X 79 59/64"

ESEMPI DI COMPOSIZIONE  
CONFIGURATION EXAMPLES

Con rete ortopedica a doghe in appoggio  
With orthopedic standing staves bedframe

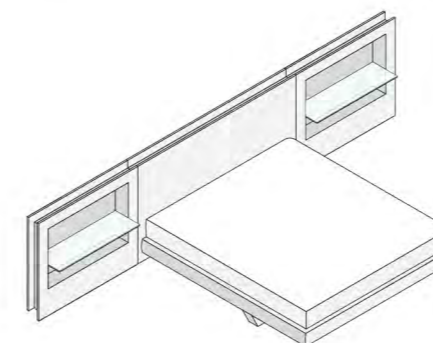

LETTO PLAN con FIANCO SX/DX 105 MENSOLA PLAN BED with DOUBLE SIDE WITH NICHE and SHELVES 41 11/32"

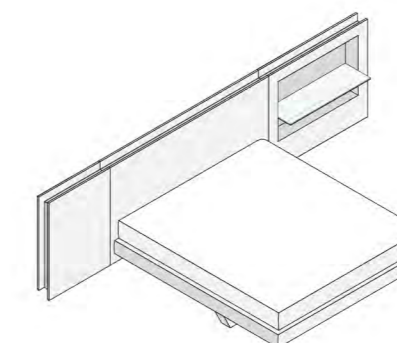

LETTO PLAN con FIANCO SX 65 FIANCO DX 105 MENSOLA PLAN BED with RIGHT SIDE 41 11/32" with NICHE and SHELF AND LEFT SIDE 25 19/32"

CON CASSETTO

CARATTERISTICHE  
FEATURES

CARTER DI COMPENSAZIONE E COPRIRETE IN TESSUTO OPZIONALI  
OPTIONAL ADJUSTMENT CARTERS AND BEDFRAME FABRIC COVERING

NON REGOLABILE IN ALTEZZA  
NOT POSSIBLE TO ADJUST THE HEIGHT

SOLO TESTATA  
HEADBOARD ONLY

**LETTO PLAN H 14,8**  
**PLAN BED H 14,8**

Design Simone Cagnazzo

Giroletto A 14,8 cm in tessuto sfoderabile  
Il tessuto è abbinabile sia al fondo del  
modulo laterale con nicchia opzionale  
in vetro con stampa digitale sia alla testata  
opzionale in appoggio.  
Con piedi in metallo nero e con rete  
ortopedica a doghe in appoggio.

*Bed frame in removable fabric H 14,8 cm.  
The fabric can be combined both with  
the bottom of the side item with optional  
glass niche and digital print,  
with the optional upholstered headboard.  
With metal feet and with orthopedic  
slatted bedframe.*



**LETTO PLAN H 17**  
**PLAN BED H 17**

Design Simone Cagnazzo

Con giroletto in tessuto  
sfoderabile h 17 cm.  
Il tessuto è abbinabile sia  
al fondo del modulo laterale  
con nicchia opzionale in vetro  
con stampa digitale sia alla  
testata opzionale in appoggio.

*With bed frame in removable  
fabric h 17 cm.  
The fabric can be combined  
both with the bottom of the side  
item with optional glass niche,  
digital print, with the optional  
upholstered headboard.*

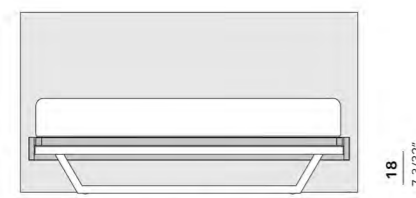

**150 - Q - 160 - 180 - K** materassi  
59 1/16" - Q - 62 63/64" - 70 55/64" - K  
171 - 171 - 178 - 198 - 211  
mattresses  
67 21/64" - 67 21/64" - 70 5/64" - 77 61/64" - 83 5/64"

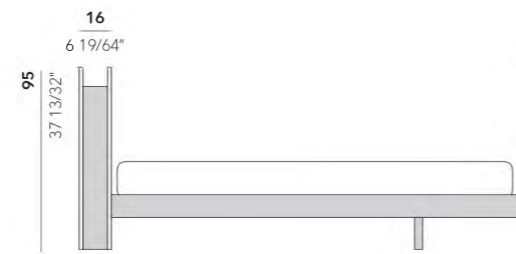

**190 - 200 - K / Q** materassi  
74 51/64" - 78 47/64" - 79 59/64"  
212,5 - 222,5 - 224,5  
mattresses  
83 21/32" - 87 19/32" - 88 25/64"

**LEGENDA:**

Q: QUEEN 153 X 203

K: KING 193 X 203

**LEGEND:**

Q: QUEEN 60 15/64" X 79 59/64"

K: KING 75 63/64" X 79 59/64"

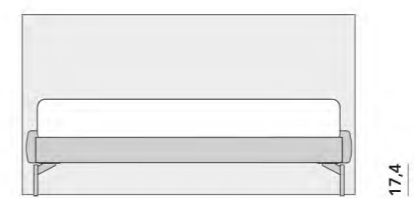

**150 - Q - 160 - 180 - K** materassi  
59 1/16" - Q - 62 63/64" - 70 55/64" - K  
171 - 171 - 178 - 198 - 211  
mattresses  
67 21/64" - 67 21/64" - 70 5/64" - 77 61/64" - 83 5/64"



**190 - 200 - K / Q** materassi  
74 51/64" - 78 47/64" - 79 59/64"  
219 - 226 - 229  
mattresses  
86 7/32" - 88 31/32" - 90 5/32"

**LEGENDA:**

Q: QUEEN 153 X 203

K: KING 193 X 203

**LEGEND:**

Q: QUEEN 60 15/64" X 79 59/64"

K: KING 75 63/64" X 79 59/64"

ESEMPI DI COMPOSIZIONE  
CONFIGURATION EXAMPLES

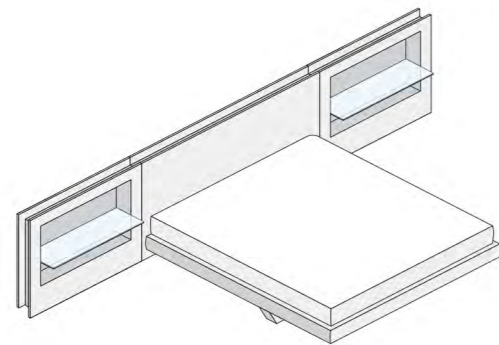

LETTO PLAN con 2 MODULI LATERALI L 105 CM  
con NICCHIA e MENSOLA  
PLAN BED with 2 LATERAL ITEMS W 41 11/32" with  
NICHE and SHELF

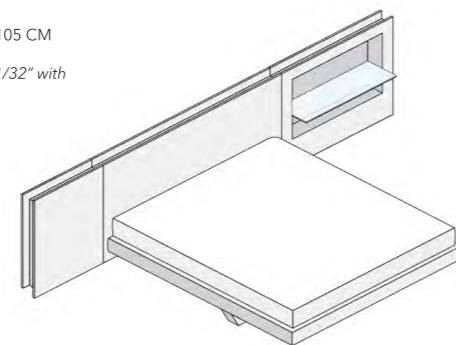

LETTO PLAN con 1 MODULO  
LATERALE L 65 CM e 1 MODULO LATERALE  
L 105 CM  
PLAN BED with 1 LATERAL ITEM W 25 19/32" and  
1 LATERAL ITEM W 41 11/32"

CARATTERISTICHE  
FEATURES



non regolabile in altezza  
not possible to adjust the height

CARTER DI COMPENSAZIONE E COPRIRETE IN TESSUTO OPZIONALI  
OPTIONAL ADJUSTMENT CARTERS AND BEDFRAME FABRIC COVERING



ESEMPI DI COMPOSIZIONE  
CONFIGURATION EXAMPLES

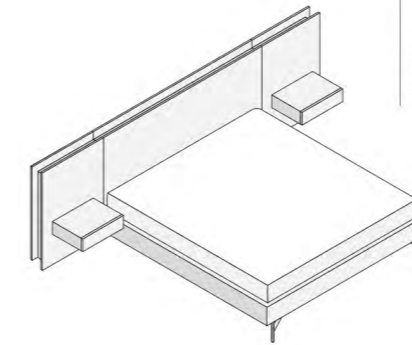

LETTO PLAN con FIANCO  
SX/DX 65 CASSETTO  
PLAN BED with DOUBLE SIDE  
25 19/32" with DRAWERS

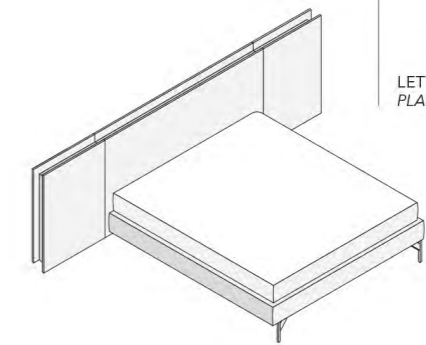

LETTO PLAN con FIANCO SX/DX 65  
PLAN BED with DOUBLE SIDE 25 19/32"

PIEDINI DISPONIBILI / finiture pag. 257  
AVAILABLE FEET / finishes page 257

CARATTERISTICHE  
FEATURES



PIEDE CLASSIC  
(di default)  
**CLASSIC FEET**  
(by default)  
H 17,4 cm  
H 6 27/32"



PIEDE MINIMAL  
(opzionale)  
**MINIMAL FEET**  
(optional)  
H 17,4 cm  
H 6 27/32"

CARTER DI COMPENSAZIONE E COPRIRETE IN TESSUTO OPZIONALI  
OPTIONAL ADJUSTMENT CARTERS AND BEDFRAME FABRIC COVERING



**LETTO PLAN H 27**  
**PLAN BED H 27**

Design Simone Cagnazzo

Giroletto h 27 cm in tessuto sfoderabile. Il tessuto è abbinabile sia al fondo del modulo laterale con nicchia opzionale in vetro con stampa digitale sia alla testata opzionale in appoggio.

*Bed frame in removable fabric h 27. The fabric can be combined both with the bottom of the side item with optional glass niche and digital print, with the optional upholstered headboard.*



**LETTO TENDER H 27**  
**TENDER BED H 27**

Design Simone Cagnazzo

Letto caratterizzato da un design avvolgente e da una testiera arrotondata, invitante da ogni punto di vista. Il morbido schienale rende la seduta eretta estremamente confortevole.

*Bed characterized by an enveloping design and a rounded headboard, tempting from every point of view. The soft backrest makes the upright seat extremely comfortable.*

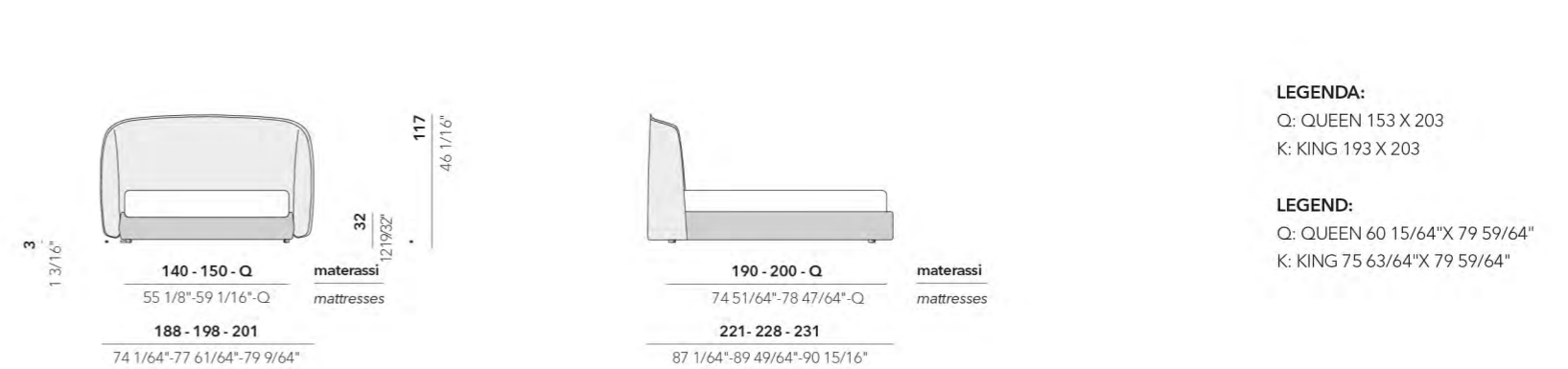
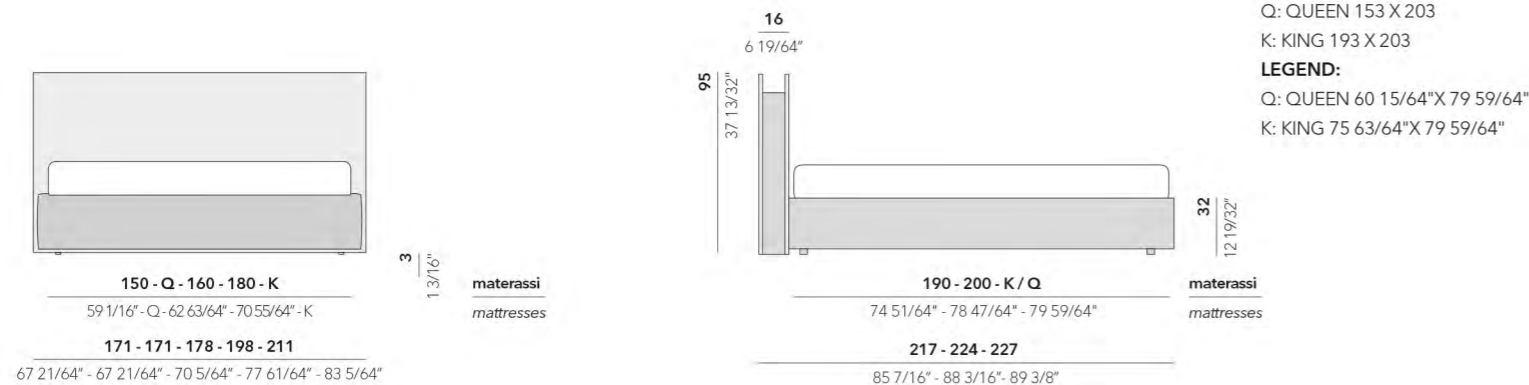

**ESEMPI DI COMPOSIZIONE**  
**CONFIGURATION DI EXAMPLES**

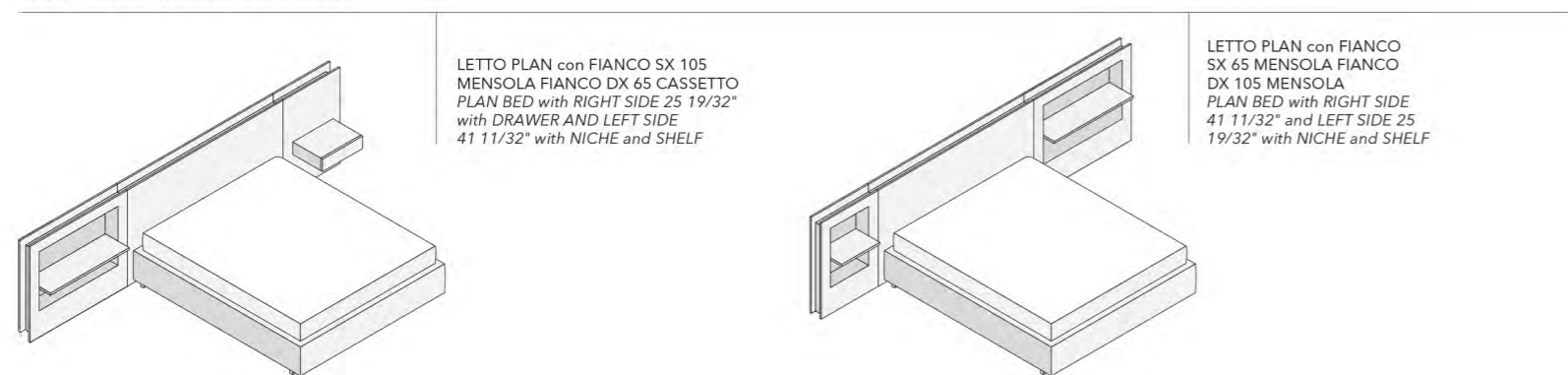

PIEDINI DISPONIBILI / finiture pag. 257  
AVAILABLE FEET / finishes page 257

CARATTERISTICHE  
FEATURES

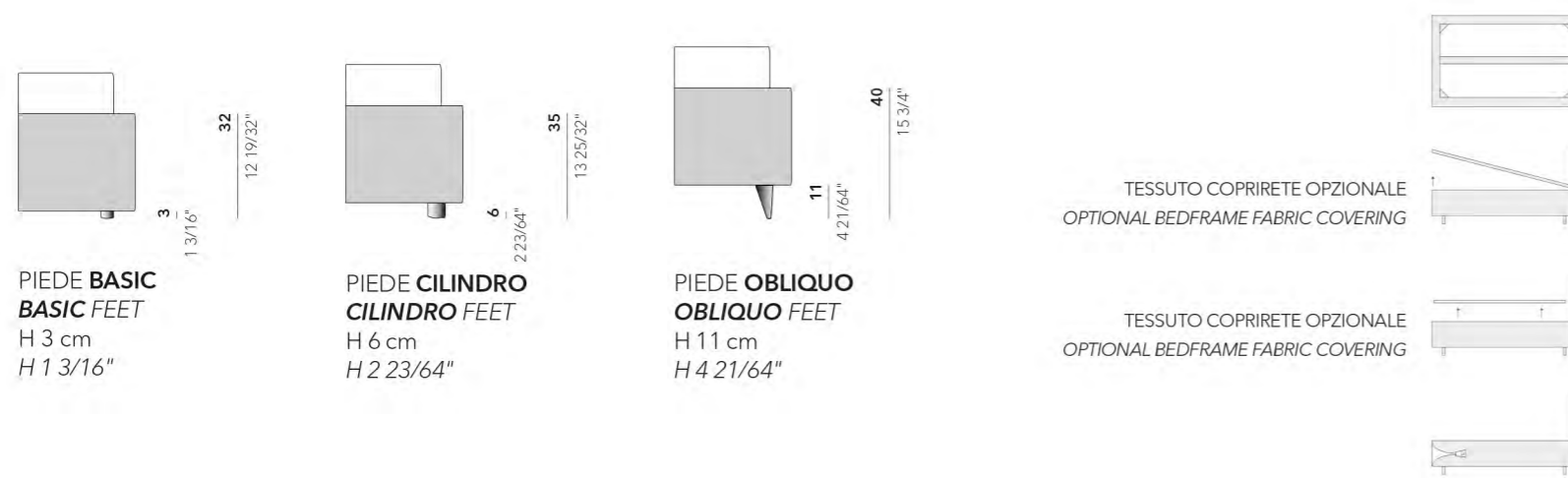

PIEDINI DISPONIBILI / finiture pag. 257  
AVAILABLE FEET / finishes page 257

CARATTERISTICHE  
FEATURES

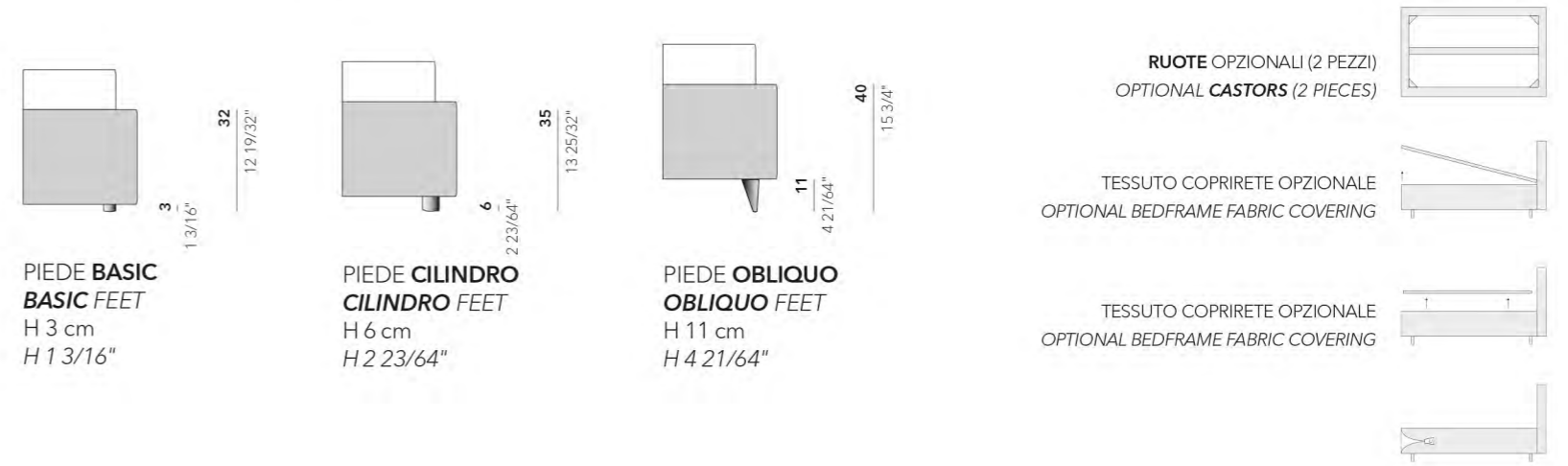

LETTO PLY H 17  
PLY BED H 17

L'eleganza di un vestito sartoriale contraddistingue il letto Ply con alamari e rifiniture al dettaglio in sintonia con la morbidezza e razionalità delle sue linee. La testata è caratterizzata da due alamari laterali in pelle di colore nero, bianco, grigio, cioccolato, blu oppure dello stesso tessuto utilizzato per il letto.

The elegance of a tailored suit distinguishes the Ply bed with frogs and detail finishes in harmony with the softness and rationality of its lines. The headboard is characterized by two lateral frogs in leather, available in black, white, grey color, chocolate, blue or in the same fabric used for the bed.



LETTO PLY H 27  
PLY BED H 27

Il Letto Ply è disponibile anche nella versione con giroletto h 27 cm.

Ply bed also available in h 10 5/8" bedframe.

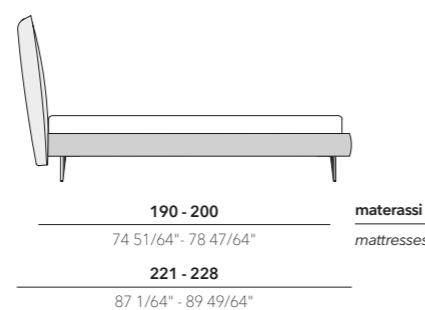
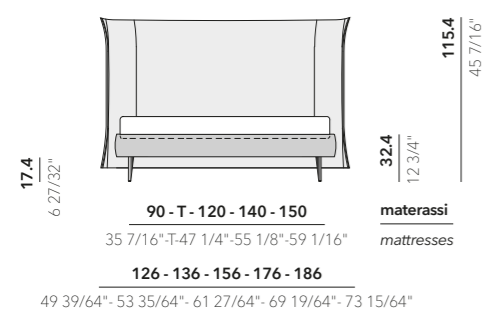

LEGENDA:

T : TWIN 100 X 200  
Q : QUEEN 153 X 203  
K : KING 193 X 203

LEGEND:

T: TWIN 39 3/8"X78 47/64"  
Q: QUEEN 60 15/64"X 79 59/64"  
K: KING 75 63/64"X 79 59/64"

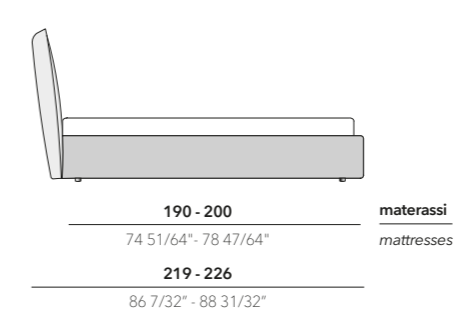
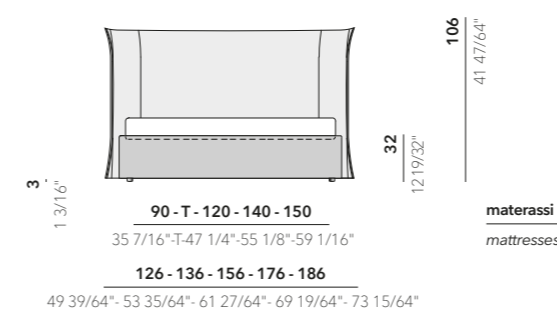

LEGENDA:

T : TWIN 100 X 200  
Q : QUEEN 153 X 203  
K : KING 193 X 203

LEGEND:

T: TWIN 39 3/8"X78 47/64"  
Q: QUEEN 60 15/64"X 79 59/64"  
K: KING 75 63/64"X 79 59/64"

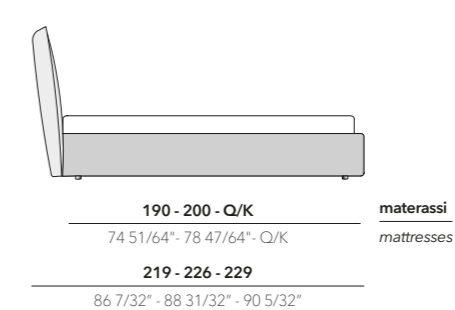
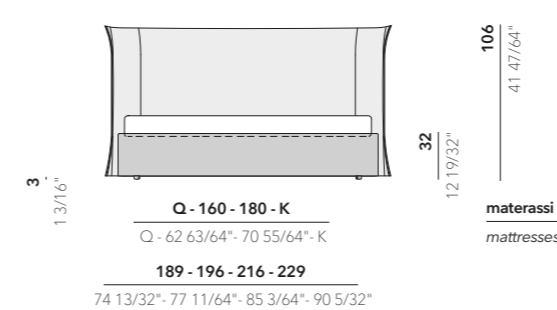
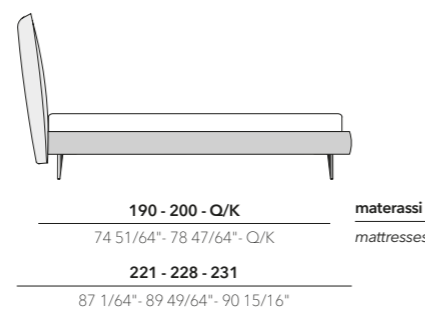
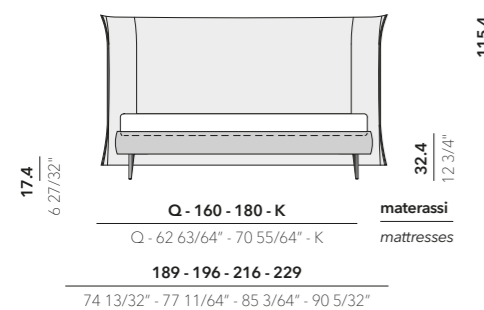

PIEDINI DISPONIBILI / finiture pag. 257  
AVAILABLE FEET/ finishes page 257

CARATTERISTICHE  
FEATURES

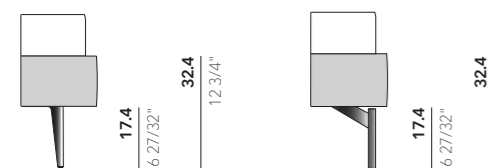

PIEDE CLASSIC  
(di default)  
CLASSIC FEET  
(by default)  
H 17.4 cm  
H 6 27/32"

PIEDE MINIMAL  
(opzionale)  
MINIMAL FEET  
(optional)  
H 17.4 cm  
H 6 27/32"

SECRET BOX **NON DISPONIBILE** PER MISURE 90 - T - 120  
SECRET BOX **NOT AVAILABLE** FOR MATTRESSES 35 7/16" - T - 47 1/4"  
CARTER DI COMPENSAZIONE E COPRIRETE IN TESSUTO OPZIONALI  
OPTIONAL ADJUSTMENT CARTERS AND BEDFRAME FABRIC COVERING

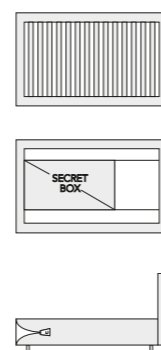

PIEDINI DISPONIBILI / finiture pag. 257  
AVAILABLE FEET/ finishes page 257

CARATTERISTICHE  
FEATURES

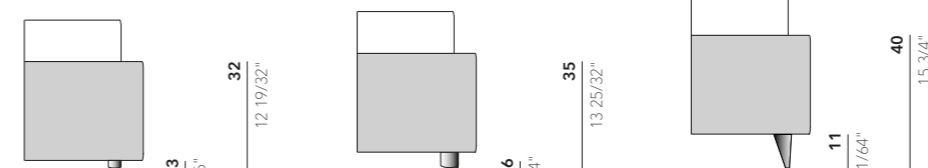

PIEDE BASIC  
BASIC FEET  
H 3 cm  
H 1 3/16"

PIEDE CILINDRO  
CILINDRO FEET  
H 6 cm  
H 2 23/64"

PIEDE OBLIQUO  
OBLIQUO FEET  
H 11 cm  
H 4 21/64"

RUOTE OPZIONALI (2 PEZZI)  
OPTIONAL CASTORS (2 PIECES)



TESSUTO COPRIRETE OPZIONALE  
OPTIONAL BEDFRAME FABRIC COVERING

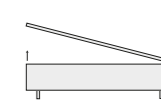

TESSUTO COPRIRETE OPZIONALE  
OPTIONAL BEDFRAME FABRIC COVERING





**LETTO TOMMY**  
**TOMMY BED**

Design Simone Cagnazzo

Il sistema letto Tommy si compone da 4 diverse misure di testata, che si sviluppano in orizzontale e da 5 basi letto che assolvono in modo completo a tutte le esigenze di spazio e comfort. Tutte le testate e le basi letto sono interamente sfoderabili

e intercambiabili. Le testate sono indipendenti fra loro e possono essere assemblate creando cadenze personalizzate, arricchite dai molti tessuti presenti nel catalogo Tumidei. La base letto è composta da un box sommiers per dare il massimo confort e da

due piedi in fusione di alluminio, che possono essere personalizzati con tutta la gamma di laccature Tumidei o ricoprirsi in tessuto grazie al rivestimento del piede tessile.

*The Tommy bed system is made up of 4 different sizes of headboards which expand horizontally and 5 bedframes which completely fulfill every space and comfort demand. All headboards and bedframes are completely removable and interchangeable.*

*The headboards are self-standing and can be assembled creating customized compositions thanks to the range of fabrics available on Tumidei catalogue. The bed-base is composed by a sommiers box, which gives the maximum comfort, and by two aluminium*

*feet, which can be personalized by using the range of Tumidei lacquered colours or they can be covered in fabric, thanks to the textile feet covering.*



ESEMPI COMPOSIZIONE  
CONFIGURATION EXAMPLES

Le misure dei materassi sono le stesse dei sommiers  
Mattress sizes are the same as the bedframes ones

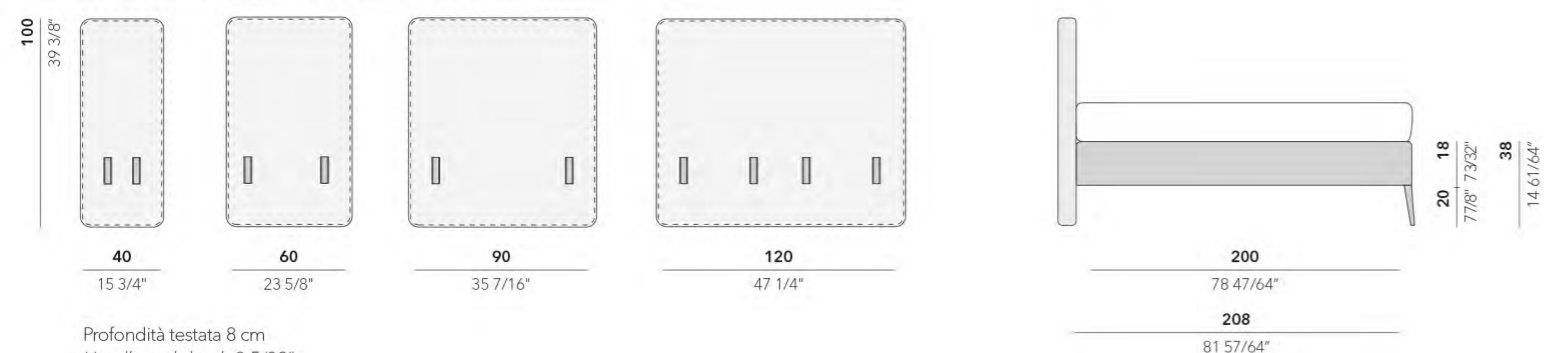

Profondità testata 8 cm  
Headboard depth 3 5/32"

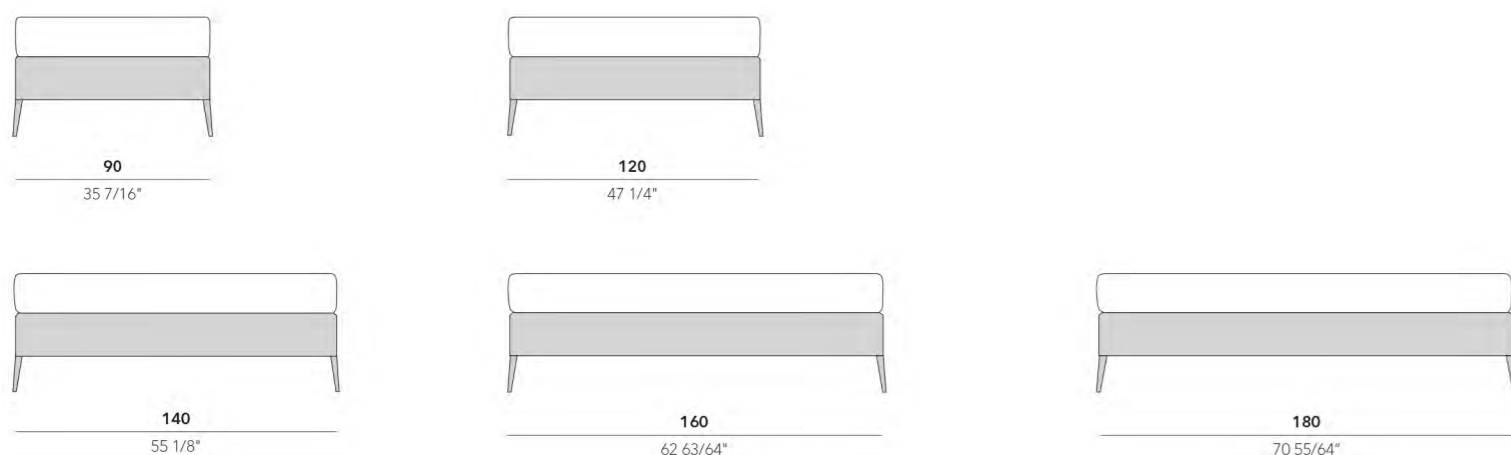

PIEDINI DISPONIBILI / finiture pag. 257  
AVAILABLE FEET / finishes page 257



PIEDE IN TESSUTO  
FEET IN FABRIC



PIEDE IN ALLUMINIO  
NATURALE O LACCATO  
FEET IN NATURAL OR  
LACQUERED ALUMINIUM

Rivestimento esterno, lastra in poliuretano espanso, imbottitura in lastra di poliuretano espanso, struttura in legno massello di abete con piano di appoggio a doghe di legno rinforzato da angolari in metallo, piedi in PVC di serie.

*External covering, polyurethane foam sheet, polyurethane foam lining, solid fir wood structure with support surface and wooden slats reinforced by metal corners, standard PVC feet.*



Testata e giroletto completamente sfoderabile con possibilità di scelta tra cuciture a contrasto nei colori bianco, nero, rosso, azzurro, blu, beige. Colore Zip nera o rossa a richiesta.

*Headboard and frame completely removable with chance of contrasting stitching in the following colours: white, black, red, blue, dark blue and beige. Zip available black or red on request.*



LETTO COZY H 27  
COZY BED H 27

Elegante e rigoroso con posizione semi seduta fornisce un comodo appoggio. Imbottiture generose garantiscono una morbida accoglienza, tutta dedicata al riposo. I cuscini di testata sono caratterizzati da un alamaro centrale in pelle di colore nero, bianco, grigio, cioccolato e blu, oppure dello stesso tessuto utilizzato per il letto.

*Elegant and rigorous bed with a semi-sitting position provides comfortable resting. Generous lining ensures a soft welcome, all dedicated to relax. The main feature of these cushions is a central frog in leather, available in black, white, grey, chocolate and blue colour or in the same fabric used for the bed.*

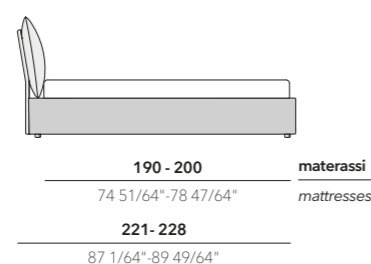
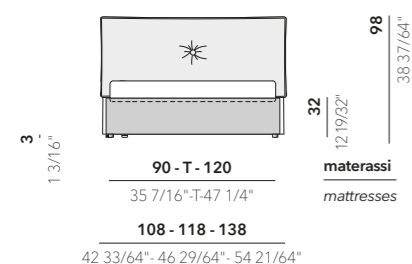

LEGENDA:

Q: QUEEN 153 X 203  
T: TWIN 100 X 200  
K: KING 193 X 203

LEGEND:

Q: QUEEN 60 15/64" X 79 59/64"  
T: TWIN 39 3/8" X 78 47/64"  
K: KING 75 63/64" X 79 59/64"

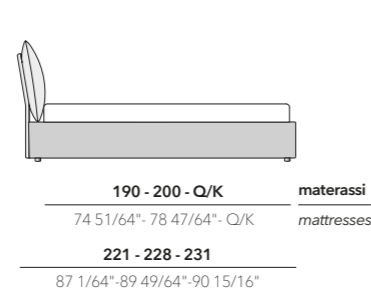
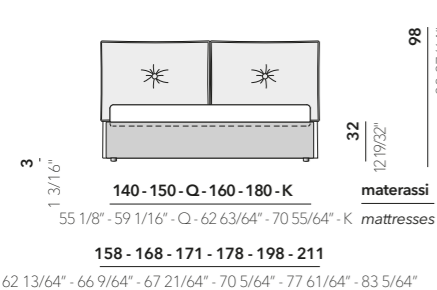

La testata è realizzata in schiumato ad iniezione. Il meccanismo di scorrimento dei cuscini della testata è composto da una slitta che ne permette il movimento adattandosi all'altezza del materasso.

*The headboard is made of injection foam. The sliding mechanism of the headboard cushions is composed by sliding rails allowing to adjust them to the height of mattress.*

PIEDINI DISPONIBILI  
AVAILABLE FEET

CARATTERISTICHE  
FEATURES

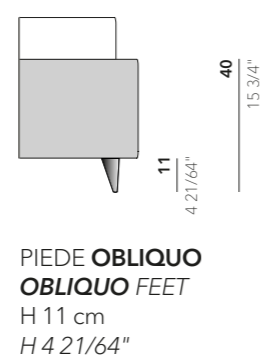
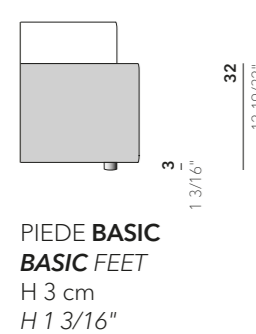

**RUOTE OPZIONALI (2 PEZZI)**  
OPTIONAL CASTORS (2 PIECES)



**TESSUTO COPRIRETE OPZIONALE**  
OPTIONAL BEDFRAME FABRIC COVERING

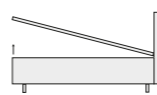

**TESSUTO COPRIRETE OPZIONALE**  
OPTIONAL BEDFRAME FABRIC COVERING

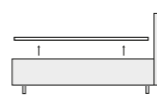

GIROLETTO E TESTATA SFODERABILE **ESCLUSO I CUSCINI\***  
BEDSTEAD AND HEADBOARD REMOVABLE **CUSHIONS EXCLUDED\***

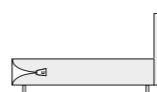

\* VARIANTE TOTALMENTE SFODERABILE CON CUSCINI SENZA ALAMARI  
\* TOTALLY REMOVABLE VERSION WITH CUSHIONS WITHOUT FROGS

TIPOLOGIE PIEDINI GIROLETTO H 17 cm  
BEDFRAME FEET TYPE H 6 11/16"



**PIEDE CLASSIC**  
**CLASSIC FEET**

H 17.4 cm  
finitura nero (di default)  
H 6 27/32"  
black finish (by default)



**PIEDE MINIMAL**  
**MINIMAL FEET**

H 17.4 cm  
finitura in tutti i colori  
dei laccati disponibili  
H 6 27/32"  
all lacquered colors finishes

TIPOLOGIE PIEDINI GIROLETTO H 27 cm  
BEDFRAME FEET TYPE H 10 5/8"



**PIEDE BASIC**  
**BASIC FEET**

H 3 cm  
finitura legno wenge  
H 1 3/16"  
wenge wood finish



**PIEDE CILINDRO**  
**CILINDRO FEET**

H 6 cm finitura legno  
naturale, bianco, wenge,  
polipropilene nero, bianco  
tortora, blu, grigio.  
H 2 23/64" natural, white,  
wenge wood finish,  
nero, bianco, tortora, blu, grigio  
polypropylene finish.



**PIEDE OBLIQUO**  
**OBLIQUO FEET**

H 11 cm finitura legno  
naturale, bianco, wenge,  
polipropilene nero, bianco  
tortora, blu, grigio.  
H 4 21/64" natural, white,  
wenge wood finish, nero,  
bianco, tortora, blu, grigio  
polypropylene finish.

**RUOTE H 11 cm**  
**CASTORS H 4 21/64"**

Compatibili solo con piede obliquo altezza 11 cm  
Compatible with obliquo feet h 4 21/64" only



Tortora  
Taupe



Bianco  
White



Grigio  
Grey



Nero  
Black



Blu  
Blue



Il sistema Keen si abbina con disinvoltura ad arredamenti di stile sia classico che moderno grazie al suo design minimal. Perfetta fusione tra contenuto e contenitore, grazie alla sua duttilità e alla personalizzazione delle superfici, ha inoltre la possibilità di essere personalizzata con tutte le finiture disponibili nella collezione Vetro di Tumidei.

The modern Keen system effortlessly matches with both classic and modern style furnishings thanks to its minimal design. Perfect fusion between content and container, thanks to its ductility and the various available surfaces, it can also be customized by using all the Vetro Tumidei collection available finishes.

COMODINO  
Realizzabile anche sospeso  
NIGHT TABLE  
Hanging version also available  
KEL04

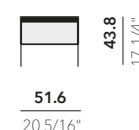

COMODINO Realizzabile anche sospeso e a terra con livellatori  
NIGHT TABLE Hanging version or on floor with level adjusters also available  
KEL05

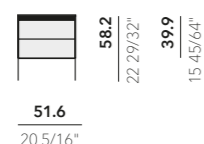

SETTIMINO Realizzabile anche a terra con livellatori  
DRESSER Also available on floor with level adjusters  
KEL07

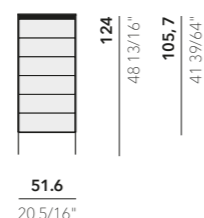

SETTIMINO Realizzabile anche a terra con livellatori  
DRESSER Also available on floor with level adjusters  
KEL17

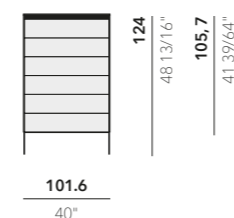

PANCA cuscino seduta opzionale  
BANQUETTE optional seat cushion  
KEL55 D/S

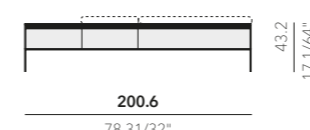

CREDENZA TV  
TV SIDEBBOARD  
KEL51 D/S  
KEL56 D/S

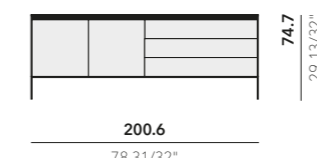

CASSETTONE  
DRESSER  
KEL52

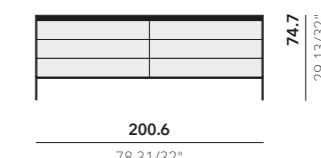

CASSETTIERA Realizzabile a terra con livellatori  
DRESSER Also available on floor level adjusters  
KEL14

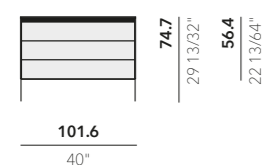

MADIA con cassetto interno opzionale  
CUPBOARD with optional inner drawer  
KEL27

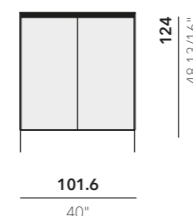

CREDENZA TV  
TV SIDEBBOARD  
KEL41 D/S  
KEL44 D/S

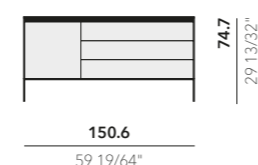

MADIA con cassetto interno opzionale  
CUPBOARD with optional inner drawer  
KEL53

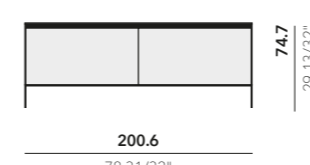

PANCA cuscino seduta opzionale  
BANQUETTE optional seat cushion  
KEL62 D/S

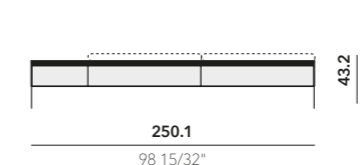

CREDENZA TV  
TV SIDEBBOARD  
KEL61 D/S  
KEL63 D/S

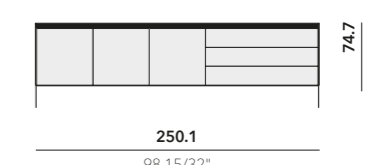

CASSETTONE  
DRESSER  
KEL42 D/S

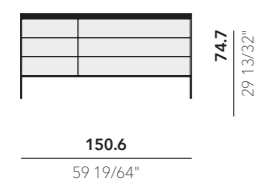

PANCA cuscino seduta opzionale  
BANQUETTE optional seat cushion  
KELD43 D/S

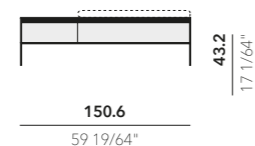

PANCA cuscino seduta opzionale  
BANQUETTE optional seat cushion  
KEL54

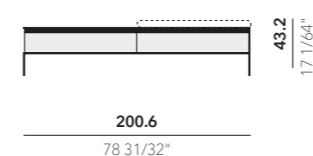

Tutti i modelli del sistema Keen hanno **PROFONDITÀ 49,2 CM**

All Keen items are **19 3/8" DEEP**

La gola in metallo è di default in finitura nero, con possibilità di inserimento vetro e stampa digitale. I piedi in metallo sono sempre in finitura nero. Al top in finitura può essere applicato il vetro sp. 0.4 cm. I sistemi Keen hanno schienali rifiniti, dunque sono posizionabili a centro stanza. I frontali possono essere in finitura nobilitato, laccato, lucido e opaco, essenza lucido e opaco, vetro laccato, specchiato e stampa digitale, finiture interne solo nobilitato pelle antracite. Tutti i frontali sono comprensivi di apertura push-pull o di default, apertura standard con presa su gola superiore. Luce led opzionale su gola.

The metal slot is in black finish by default, with the possibility of applying glass and digital print. The metal feet are always in black finish. Glass 5/32" th. can be applied on finishing top. Keen systems have finished backs, for a middle room position. The front panels can be glossy and matt lacquered, glossy and matt veneer, lacquered or mirror glass and digital print. Interior finishes is antracite pelle melamine only. All front parts include push-pull opening or standard opening through upper slot by default. Optional led light on the slot.

SISTEMA CIRCLE  
CIRCLE SYSTEM



Il modernismo avvolgente dei dettagli anni 50 incontra l'artigianalità moderna, Circle, unisce la robustezza dell'ebanisteria industriale a dettagli eleganti e finiture esclusive, in una costruzione robusta e visivamente leggera al tempo stesso. Superfici personalizzabili nella collezione Vetro di Tumidei (frontali e top).

The embracing modernism of 50's details meets modern craftsmanship, Circle, combines the robustness of industrial carpentry with elegant details and exclusive finishes, to create a sturdy and visually light construction at the same time. Surfaces can be customized with all the Vetro Tumidei collection available finishes (front and top).

COMODINO  
NIGHT TABLE  
CRL07P

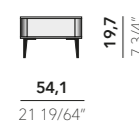

COMODINO con vano giorno  
NIGHT TABLE with open block  
CRL11P

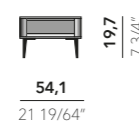

COMODINO a terra (solo con livellatori)  
NIGHT TABLE floor (with level adjusters)  
CRL08L

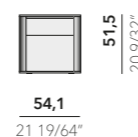

PEDANA TV  
TV PLATFORM  
CRL09P

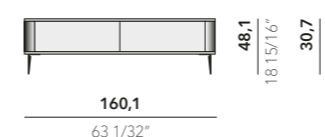

CREDENZA con ripiani in vetro.  
SIDEBOARD with glass shelves  
CRL02P

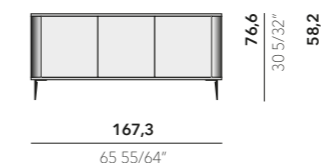

COMÒ  
CHEST OF DRAWERS  
CRL04P

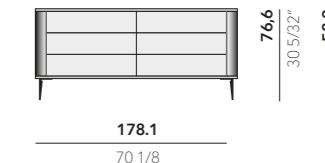

SETTIMINO  
DRESSER  
CRL06P

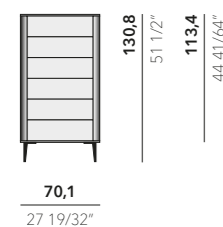

MADIA con ripiani in vetro  
CUPBOARD with glass shelves  
CRL05P

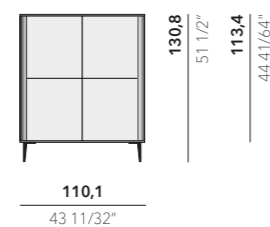

COMÒ  
DRESSER  
CRL03P

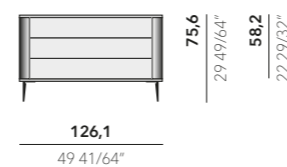

CREDENZA  
SIDEBOARD  
CRL01P S/D

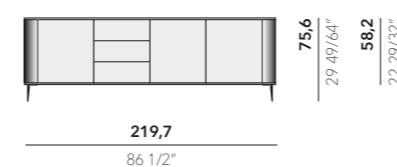

CREDENZA  
SIDEBOARD  
CRL10P

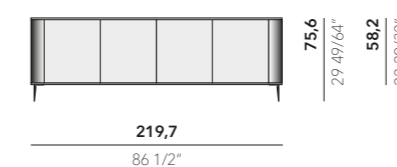

PIEDINI DISPONIBILI  
AVAILABLE FEET

Di default realizzato con piede "Classic", in alternativa, su richiesta con piede "Minimal" o con livellatori.

Carried out with "Classic" foot by default, alternatively, on request, with "Minimal" foot or level adjusters.



**PIEDE CLASSIC**  
h 17.4 cm  
finitura nero

**PIEDE CLASSIC**  
h 6 27/32" black finish



**PIEDE MINIMAL**  
h 17.4 cm finitura in  
tutti i colori dei laccati  
disponibili

**PIEDE MINIMAL**  
h 6 27/32" all lacquered  
colors finishes



**LIVELLATORI**  
**LEVELLERS**

Tutti i modelli del sistema Circle hanno **PROFONDITÀ 46,4 CM**

All Circle items are **18 17/64" DEEP**

La struttura interna è in finitura nobilitato pelle antracite, mentre i frontali in finitura nobilitato, laccato, essenza, vetro laccato, specchiato e stampa digitale. I fianchi in finitura laccato e essenza. Al top può essere applicato il vetro laccato (opzionale). I cassetti hanno apertura push pull con guide performanti. L'Interno del cassetto è di default in finitura betulla, e laccato su richiesta. I passacavi sono già inclusi nei moduli TV e aggiunti su richiesta dove non presenti.

The internal structure is in pelle antracite melamine finish. Whereas all front parts can be in melamine, lacquered, wood, lacquered or mirrored glass finish and with digital print. It is possible to add a lacquered glass as an option. Drawers are with push pull performante rails and with its inner parts in birch finish by default, in lacquered finish on demand. Cable routers are already included in the TV units and, if requested, they can be added if not provided by default.

**STAND  
STAND**

Design Simone Cagnazzo

Un'appendice funzionale ed elegante, che garantisce ordine agli oggetti personali. Molteplici sono le soluzioni, che gli permettono di adeguarsi all'ambiente della zona notte e giorno.

*A functional and elegant complement, which keeps personal items organized. Many solutions guarantee to adapt it to the night and day area.*



**STICK TAVOLINI  
COFFEE TABLE STICK**

Design Simone Cagnazzo

Leggerezza e semplicità sono i tratti distintivi dei complementi Stick. Forme ed altezze diverse danno la possibilità di comporre diverse soluzioni di appoggio, possono vivere singolarmente o insieme, creando ogni volta una nuova morfologia.

*Lightness and simplicity are the distinctive features of Stick accessories. Different shapes and heights give the opportunity to compose different solutions, they can live individually or together, each time creating a new morphology.*

Tavolino in metallo nero, con possibilità di personalizzare il top con con tutte le finiture disponibili nella collezione Vetro di Tumidei, vetri retrolaccati o specchiati.

*Black metal coffee table, with the possibility of customizing the top with all the Vetro Tumidei collection available finish.*



ESEMPI DI CONFIGURAZIONE  
CONFIGURATION EXAMPLES

STD11

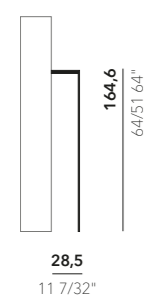

STP11

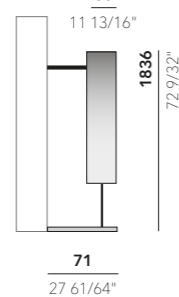

STF31

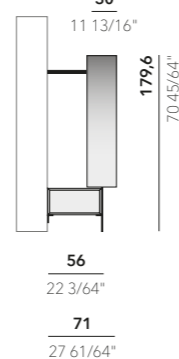

STF41

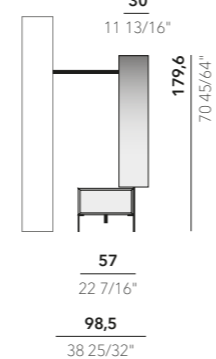

STF12 + NW12

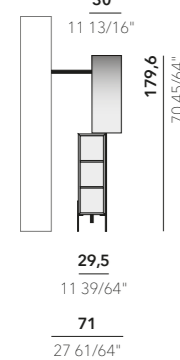

STF23 + NW23

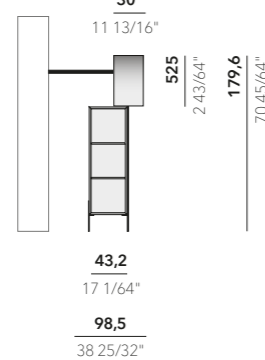

STC22

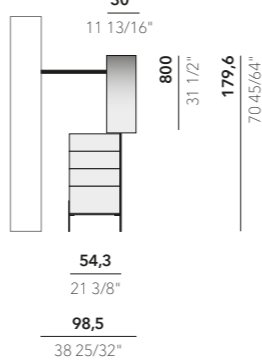

STC13

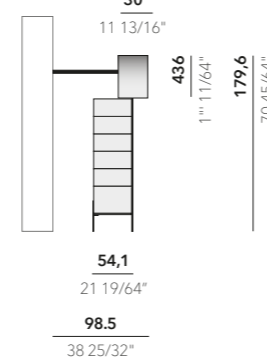

TCK01

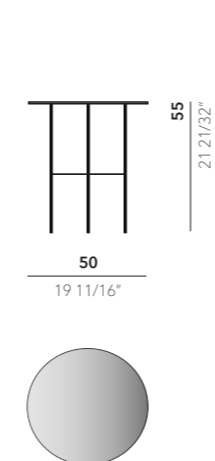

TCK02

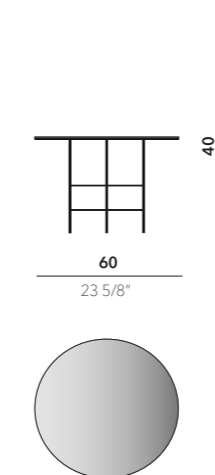

TCK03

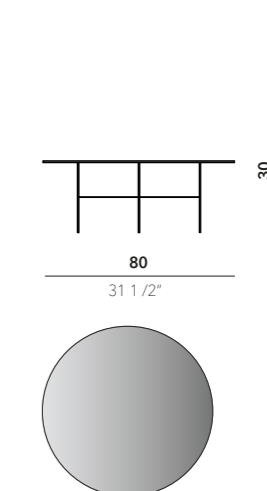

Da fissare a muro o su fianco armadio o libreria.

*To be fixed to wall or wardrobe or bookshelf side.*

Struttura tavolino in metallo nero.  
Con piano in vetro laccato, specchiato  
o stampa digitale.

*Coffee table structure in black metal finish  
with top in lacquered, mirrored glass or digital  
print finish.*



## VETRO®

VeTro, vero, non un gioco di parole ma una tecnologia ideata dal nostro laboratorio che dà vita ad un connubio tra la lucentezza del vetro e la purezza di molteplici materiali nobili. Questo permette una visione rivoluzionaria attraverso la lente di VeTro del mondo materico che caratterizza e rende uniche le Collezioni Tumidei.

*VeTro, vero, not a play on words but a technology which Tumidei's Lab conceived to create a combination between the sheen of the glass and the pureness of several selected materials. This leads to a revolutionary vision of the matter world through veTro's lens that characterizes all the Tumidei's Collections, making them unique.*

MARMI



TESSUTI



LEGNI

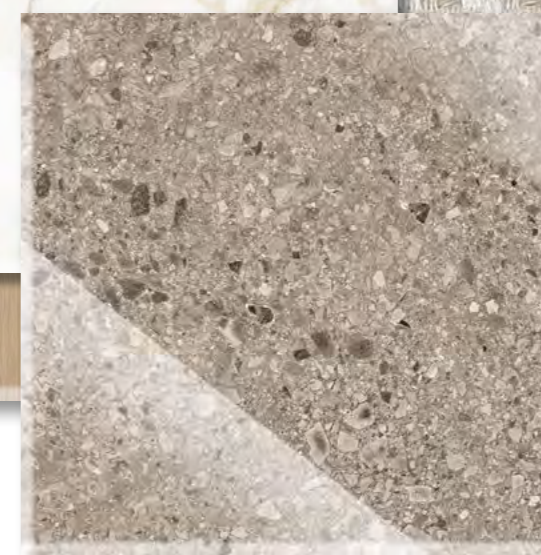

GRANIGLIE

**FINITURE  
FINISHES**

BE SPOKE  
BE SPOKE

Il coraggio nel proporre un nuovo modo di vivere spazi e luoghi all'insegna della creatività, VETRO, vero, non un gioco di parole ma una tecnologia ideata dal nostro laboratorio che dà vita ad un connubio tra la lucentezza del vetro e la purezza di molteplici materiali nobili. Questo permette una visione rivoluzionaria attraverso la lente di VETRO del mondo materico che caratterizza e rende uniche le collezioni Tumidei.

*The courage to present a new way of living spaces and places dominated by creativity: VETRO, vero, not a play on words but a technology conceived by Tumidei's lab which creates a combination between the sheen of the glass and the pureness of several selected materials. This leads to a revolutionary vision of the matter world through VETRO's lens that characterizes all the Tumidei's collections, making them unique.*

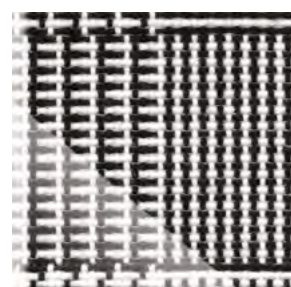

**A/**  
VETRO  
GLASS  
WDCON100

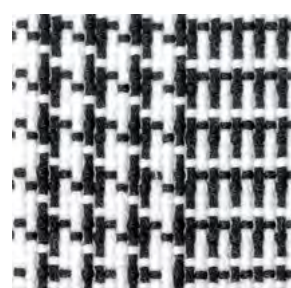

**B/**  
STAMPA SU LEGNO  
PRINT ON WOOD  
CON100



**C/**  
TESSUTO  
FABRIC  
CON100



WDBLI001



WDBLI005

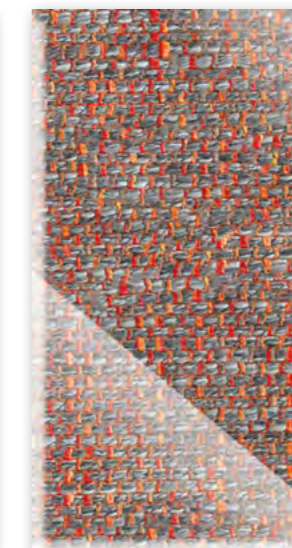

WDBLI016



WDBLI018



WDBLI021



WDBLI023



WDCAN002



WDCAN011



WDCAN012



WDCON007

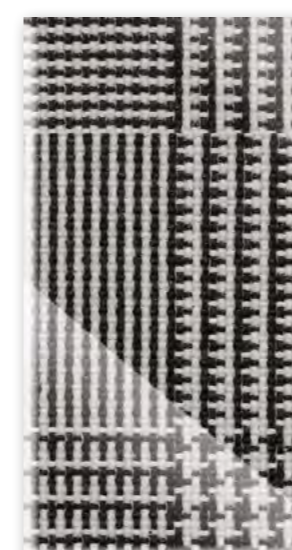

WDCON032



WDCON100



WDSCU004



WDSCU006



WDSCU007



WDT240

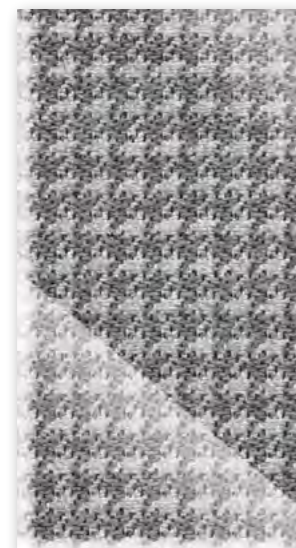

WDT241

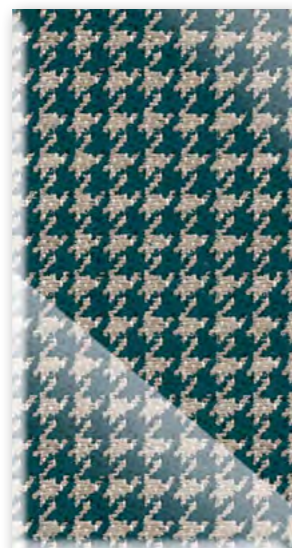

WDT242



WDT243



WDT244



WD DER 7807-01



WD DER 7807-02



WD DER 7807-04



WD 368-01

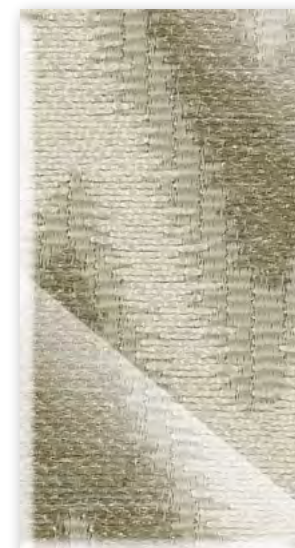

WD 368-02



WDT245



WDT246



WDT260



WDT261



WDT262



WD 369-01



WD 369-03



WD 437-01



WD 437-03



WD 437-04



WD KIR 7806-01



WD KIR 7806-03



WD KIR 7806-05



WD 437-05



WD 437-06



WD 437-07



WD ERBA 0007



WD ERBA 0015





WD ERBA 0022



WD ERBA 0069



WD MARE 0007



WD MARE 0015



WD MARE 0022



WDCEM001

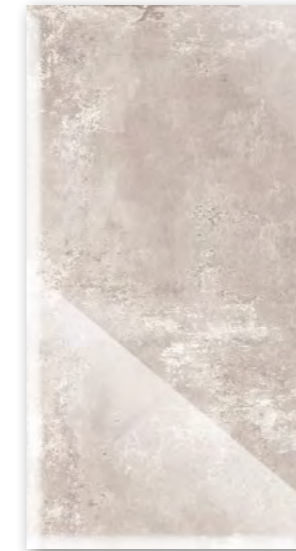

WDCEM002



WDGRAN01



WDGRAN02



WD MARE 0069



WD JAM DIS.1 C9



WD JAM DIS.1 C20



WD JAM DIS.1 C25



WD JAM DIS.1 C50

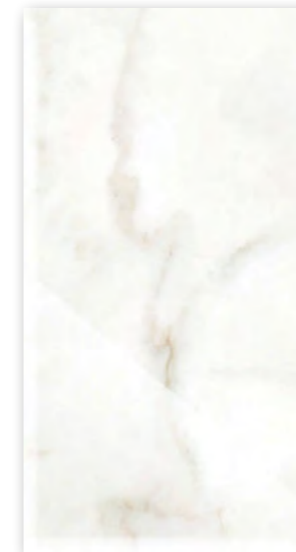

WDMAR001

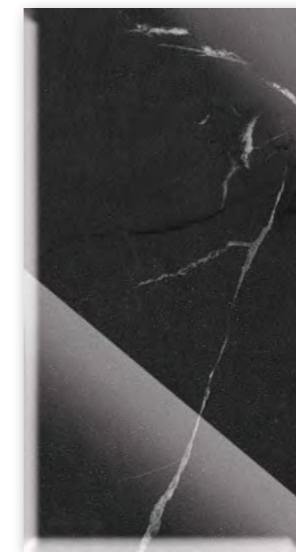

WDMAR002



WDMAR003

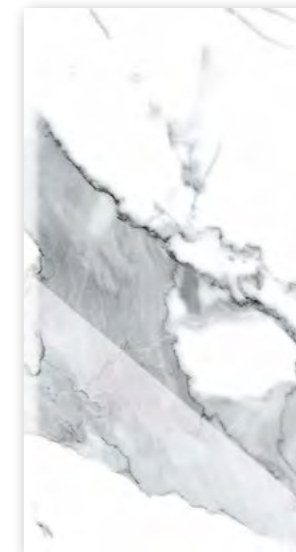

WDMAR004

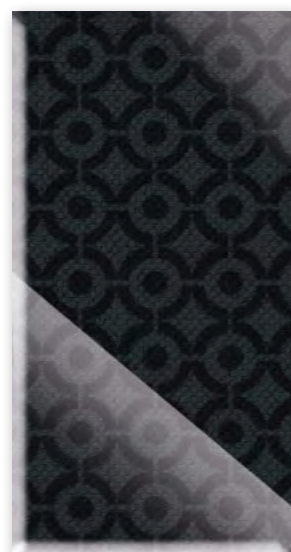

WD JAM DIS.2 C22



WD JAM DIS.2 C31



WD JAM DIS.2 C37



WD JAM DIS.2 C57



WDLEGN E1



WDLEGN E3



WDLEGN FF

**VETRO SPECCHIATO**  
**MIRRORED GLASS**

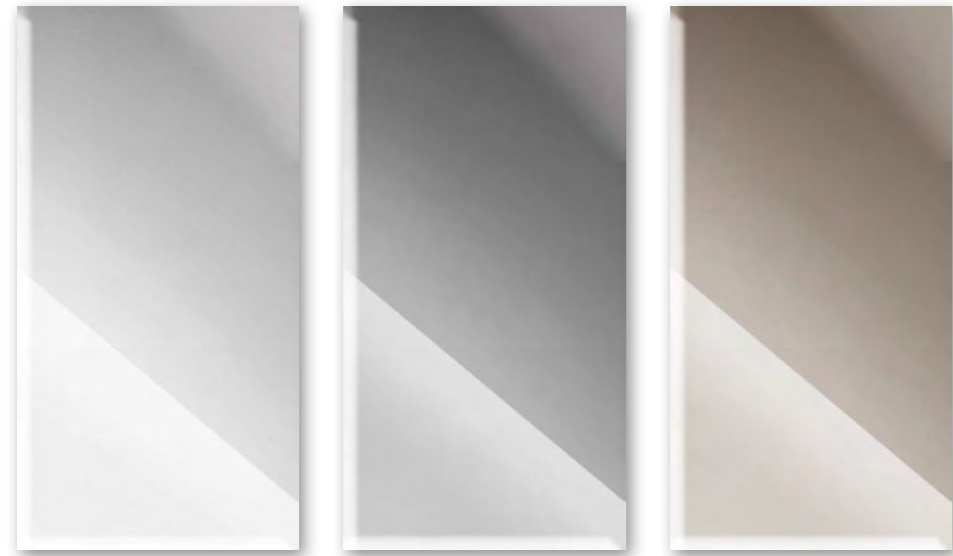

SP  
SPECCHIATO  
MIRRORED

SG  
SPECCHIATO GRIGIO  
MIRRORED GREY

SB  
SPECCHIATO BRONZO  
MIRRORED BRONZE

Utilizzabile su ante vetro  
composte da vetro  
specchiato sp.0,4 cm e  
pannello legno sp. 1,6 cm

*To be used on glass doors  
composed by:  
mirrored glass th. 5/32"  
and wooden panel th.5/8"*

**VETRO TRASPARENTE**  
**TRANSPARENT GLASS**

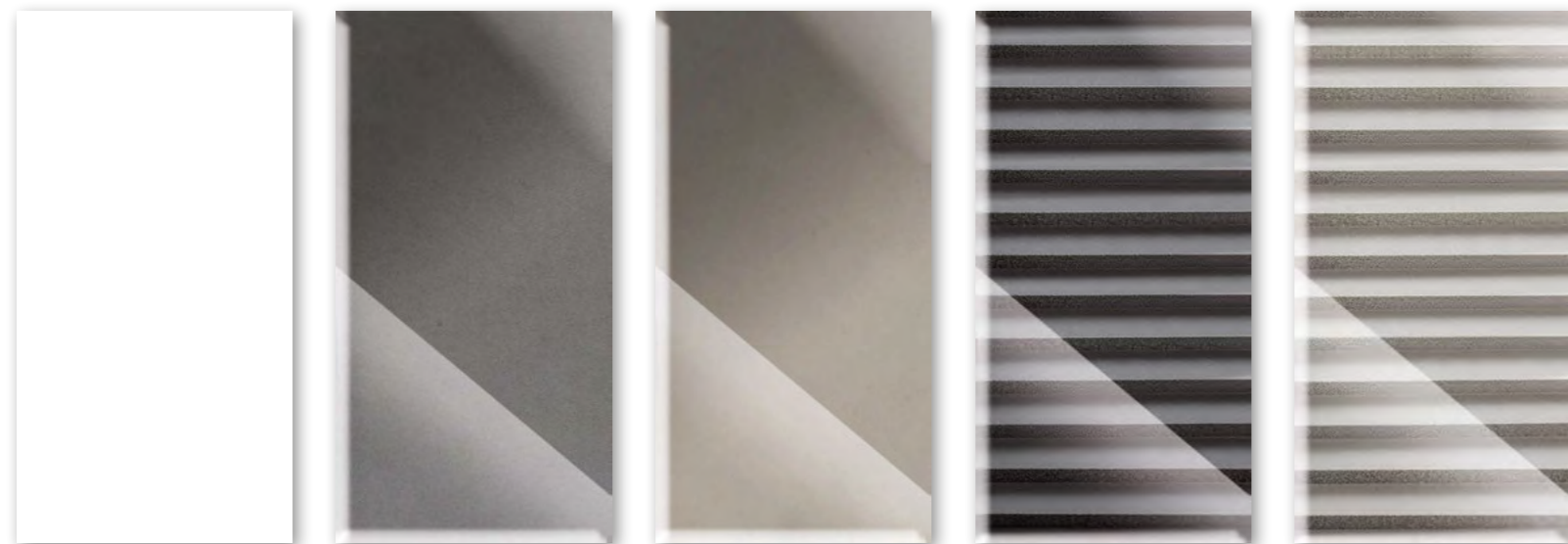

VT  
VETRO EXTRACHIARO  
EXTRQACLEAR GLASS

FU  
VETRO FUMÈ  
SMOKED GLASS

SS  
VETRO STOP-SOL  
STOP-SOL GLASS

NERO

Stampa digitale a righe  
orizzontali nero  
(solo con vetro fumè)

*Digital print with  
horizontal stripes  
(with smoked glass only)*

TORTORA

Stampa digitale a righe  
orizzontali tortora  
(solo con vetro fumè)

*Digital print with  
horizontal stripes  
(with smoked glass only)*

**TESSUTO IN RILIEVO SEMI-TRASPARENTE**  
**SEMI-TRANSPARENT RAISED FABRIC**

Pellicola tessuto da  
applicare esclusivamente  
su ante vetro con telaio  
nero alluminio ART.ATA  
47/48

*Fabric film to be applied  
on blackframed glass door  
ART.ATA47/48 only*

Solo con vetro  
trasparente extrachiario

*With extra-clear  
transparent glass only*



01 CHALK NERO

02 ROCK

03 ASH



04 OAK

05 BONE

06  
CHALK BIANCO

NOBILITATI PER FRONTALI  
MELAMINES FOR FRONT PARTS

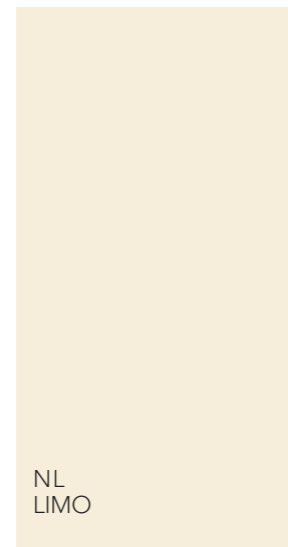
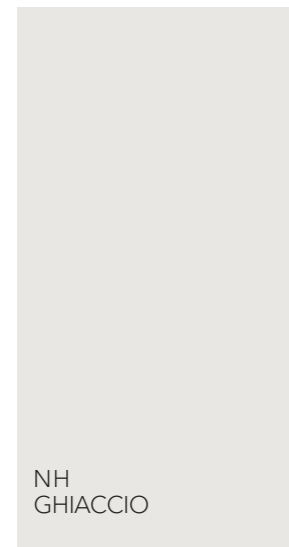
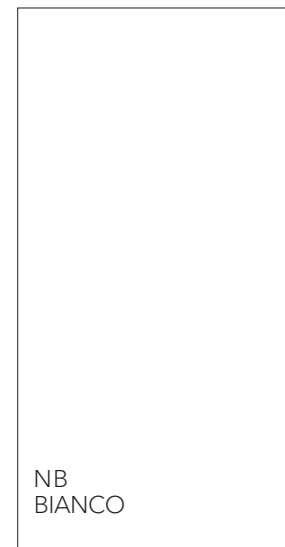

NOBILITATI PER INTERNI  
MELAMINES FOR INNER PARTS

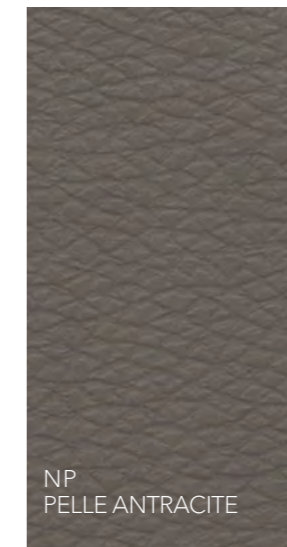
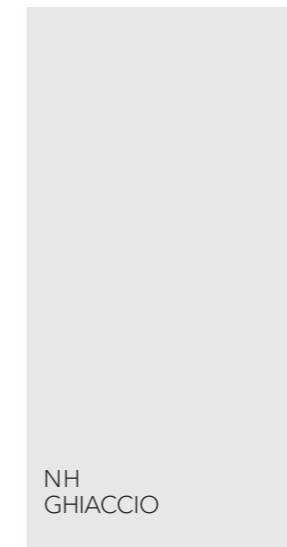

Colori indicativi.  
Per verificare i toni reali  
consultare campioni.

Colours as indications.  
In order to check the real  
shades, refer to samples.

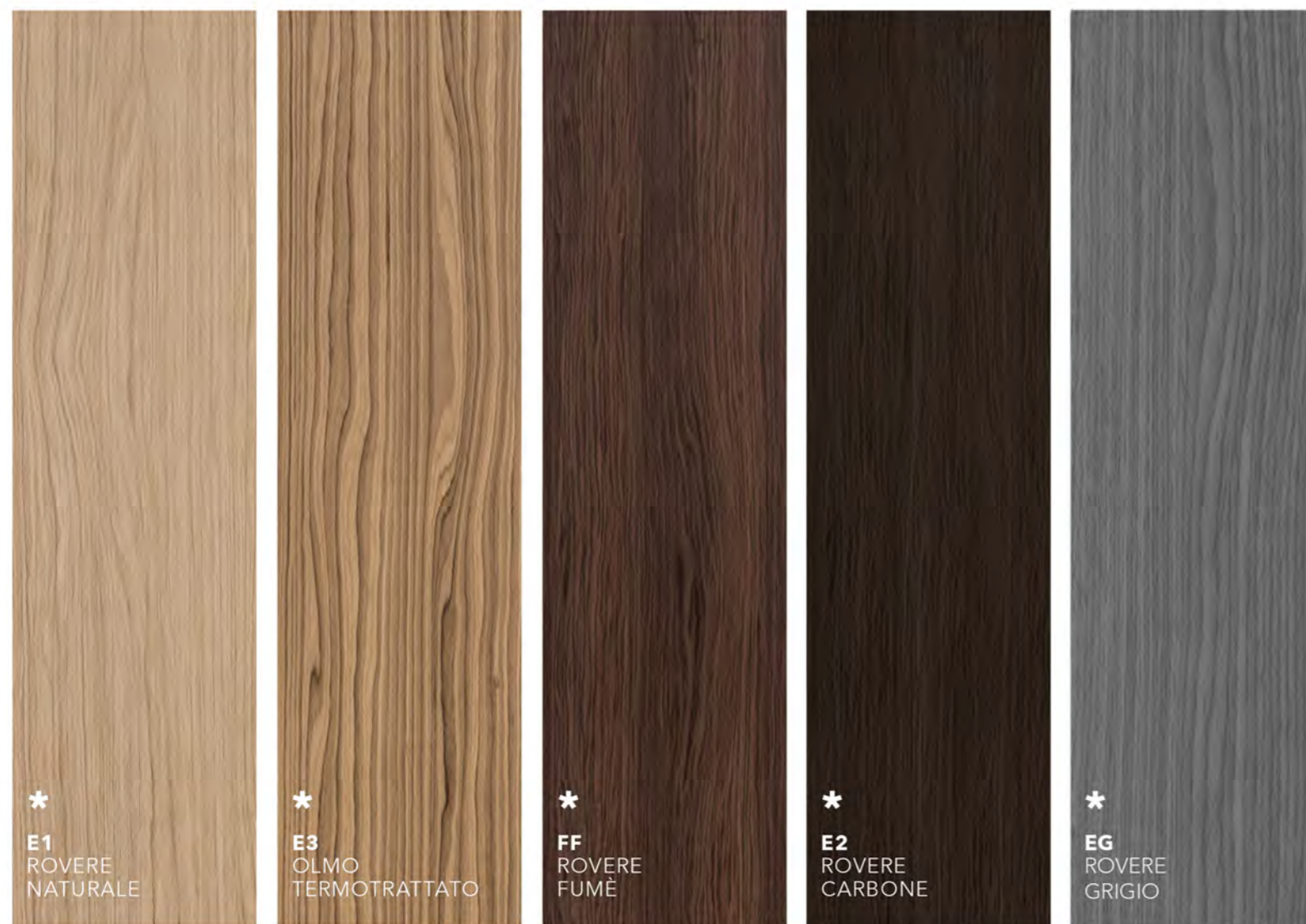

\* Per questi colori è possibile avere la finitura ESSENZA LUCIDA (EL).

Colori indicativi. Per verificare i toni reali consultare campioni.

\* GLOSSYWOOD (EL) finish available for these colours.

Colours as indications. In order to check the real shades, refer to samples.

LACCATI OPACO - LUCIDO\* / VETRO EXTRACHIARO RETRO LACCATO  
MATT - GLOSSY LACQUERED\* / EXTRA-CLEAR LACQUERED GLASS



\* Questi colori sono disponibili anche in finitura LACCATO LUCIDO

\* These colours are available in GLOSSY LACQUERED finish too

Colori indicativi. Per verificare i toni reali consultare campioni.

Colours as indications. In order to check the real shades, refer to samples.



La stampa digitale dei tessuti è riproducibile su tutte le superfici in vetro degli arredi Tumidei, garantendo un'abbinamento originale ed unico.

*The fabric digital prints can be repeated on all glass surfaces of the tumidei furniture, providing an original and unique combination.*

437 - 05

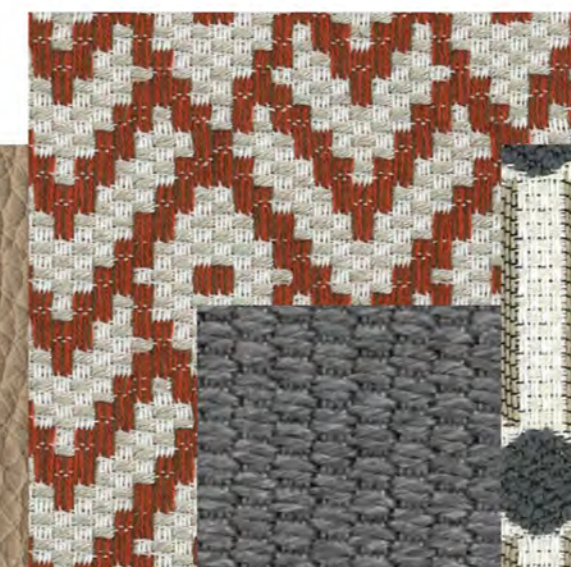

KIR 7806 - 05



MAR744



SURF 0074

KIR TeE



KIR 7806 - 01



KIR 7806 - 03



KIR 7806 - 05

437 TeD



437 - 01



437 - 03



437 - 04

DER TeE



DER 7807 - 04



DER 7807 - 02

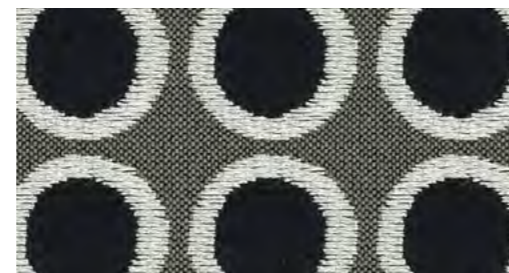

DER 7807 - 01



437 - 05



437 - 06



437 - 07

368 /369 TeD

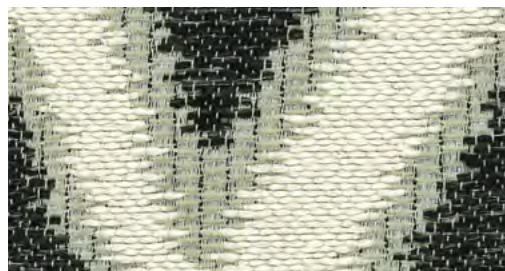

368 - 01



368 - 02



369 - 01



369 - 03

M 146 TeD



M 146 - 22



M 146 - 20

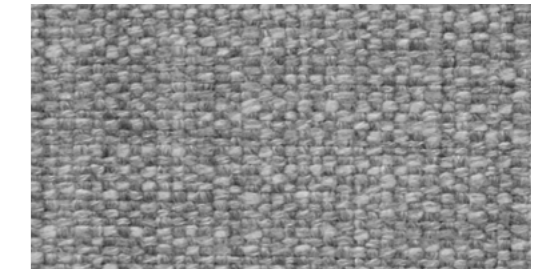

M 146 - 05



M 146 - 03



M 146 - 08

SURF TeE



SURF 0100



SURF 0007

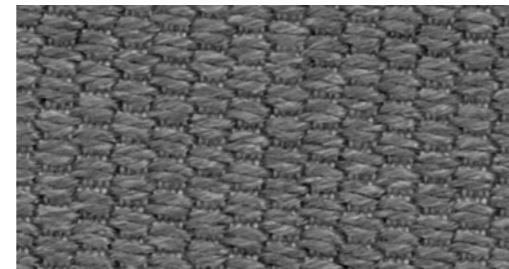

SURF 0074

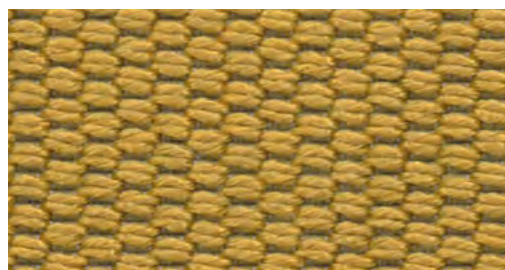

SURF 0069

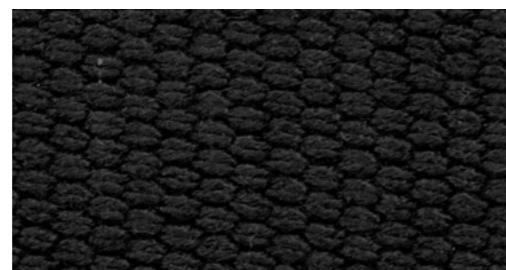

SURF 0022

ERBA TeD



ERBA 0007



ERBA 0015



ERBA 0022



ERBA 0069

MARE TeD



MARE 0007



MARE 0015



MARE 0022



MARE 0069

JAM TeB



JAM DIS. 1 C9



JAM DIS. 1 C20

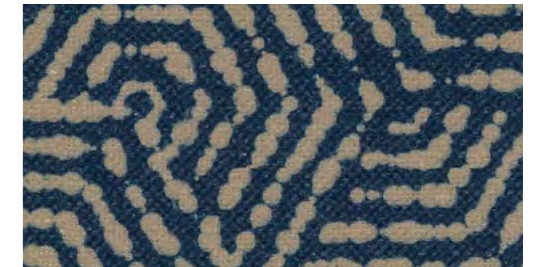

JAM DIS. 1 C25



JAM DIS. 1 C50



JAM DIS. 2 C57



JAM DIS. 2 C31



JAM DIS. 2 C37

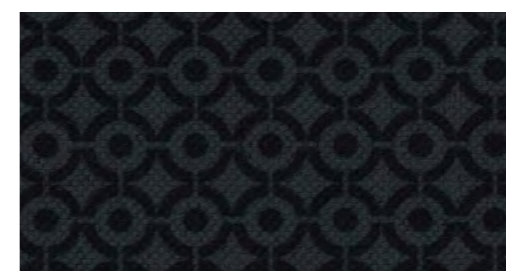

JAM DIS. 2 C22

PIED DE POULE Te3



T240



T241

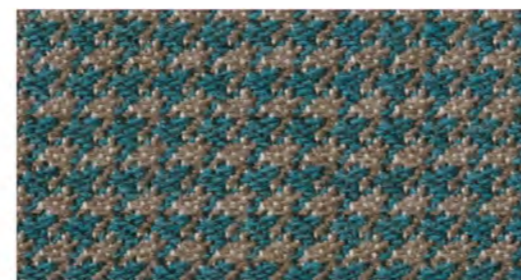

T242



T243

FANTASIA / PATTERNED Te3



T244



T245



T246

CAN CAN - TeD



CAN011



CAN002



CAN025



CAN012

SCUBIDU VICHY - TeB

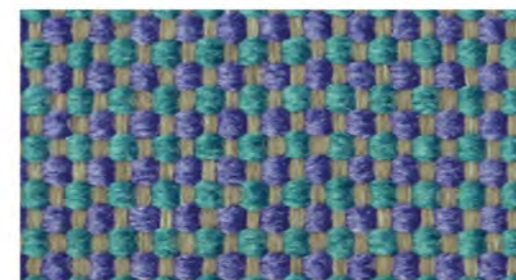

SCU004

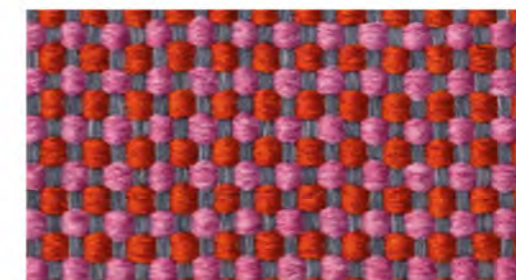

SCU007

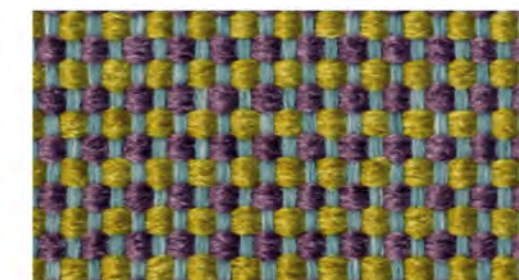

SCU006

CONNERY - TeD

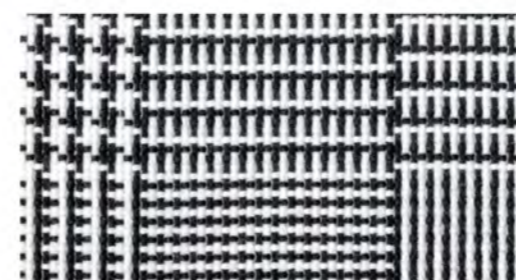

CON100

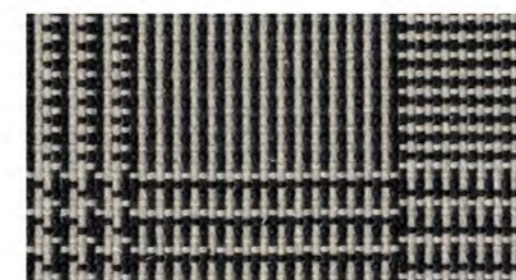

CON032



CON007

Colori indicativi. Per verificare i toni reali consultare campioni.

Colours as indications. In order to check the real shades, refer to samples.



ASTON - TeE

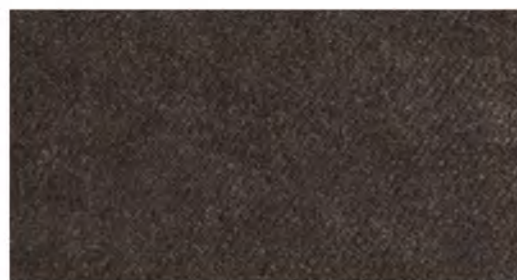

AST025

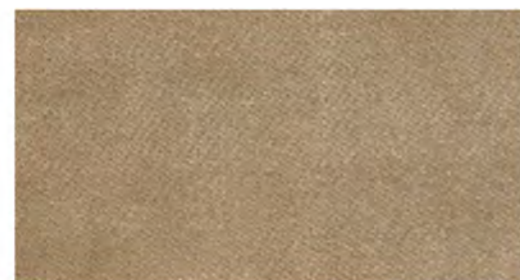

AST003



AST092

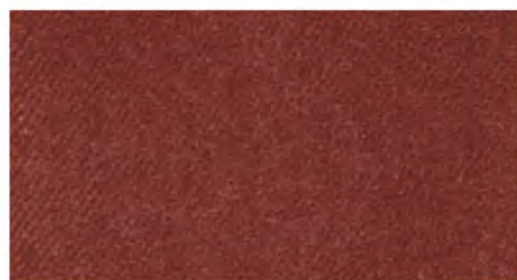

AST053

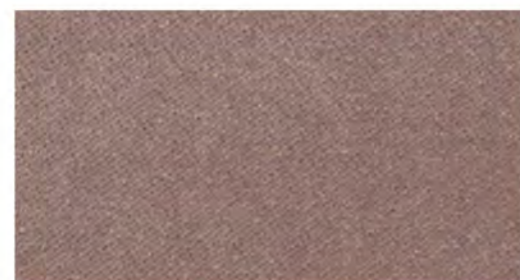

AST029

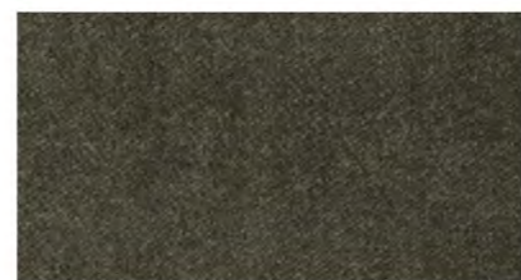

AST099

BLIZZARD - TeD



BLI018

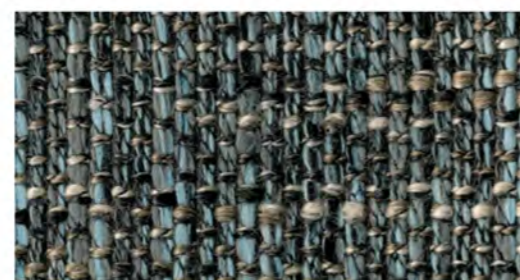

BLI021



BLI023

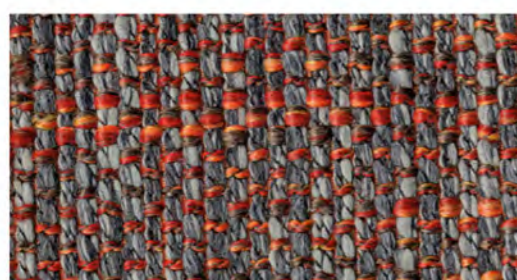

BLI016



BLI001



BLI005

MIZAR - TeB



MIZ009



MIZ011



MIZ010



MIZ020



MIZ014

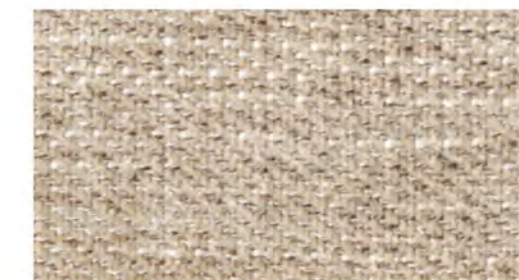

MIZ006

Colori indicativi. Per verificare i toni reali  
consultare campioni.

Colours as indications. In order to check the  
real shades, refer to samples.

SESIA - TeB



SES012



SES009

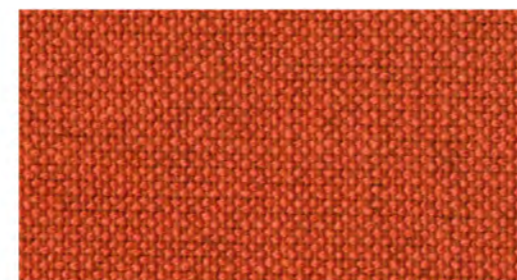

SES028



SES026



SES005

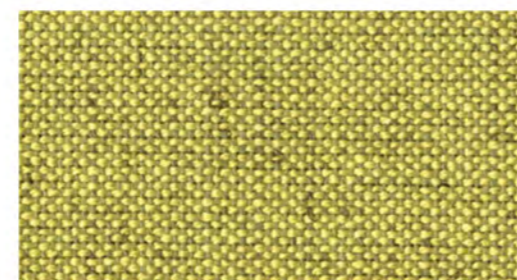

SES030



SES029



SES021



SES003

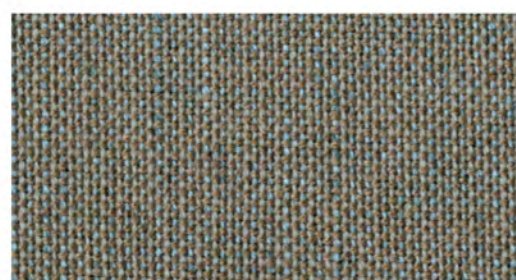

SES023



SES033



SES016

GRACE - TeB



GRA001



GRA016



GRA015



GRA022



GRA009



GRA030



GRA006



GRA012



GRA033



GRA010



GRA011

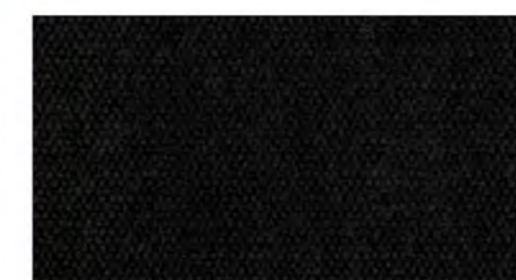

GRA036

Colori indicativi. Per verificare i toni reali  
consultare campioni.

Colours as indications. In order to check the  
real shades, refer to samples.

PELLE MARTELLATA - PeA



MAR765



MAR744



MAR752



MAR731

ELEGANCE - PeB



ELE301

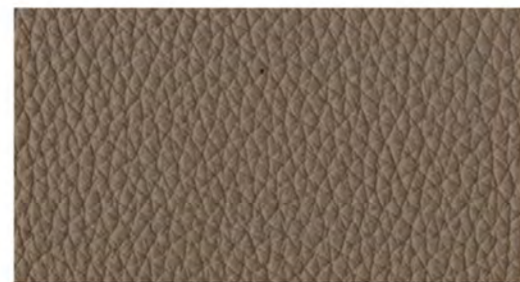

ELE304

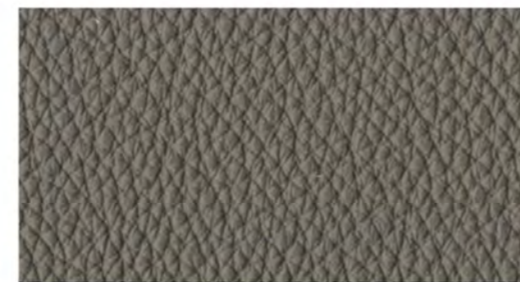

ELE204

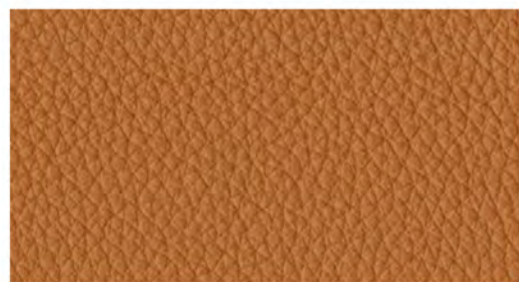

ELE218

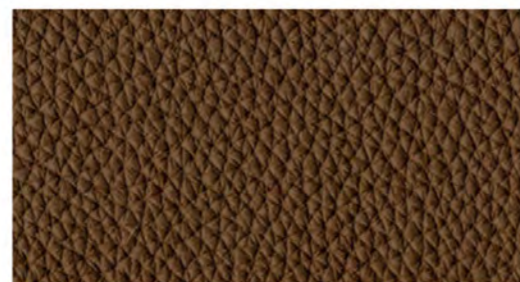

ELE217



ELE207

Colori indicativi. Per verificare i toni reali consultare campioni.

Colours as indications. In order to check the real shades, refer to samples.

SAUVAGE - PeB



SAU031



SAU032



SAU034



SAU036



SAU037



SAU038

ECOPELLE - TeA



ECO111



ECO101



ECO606

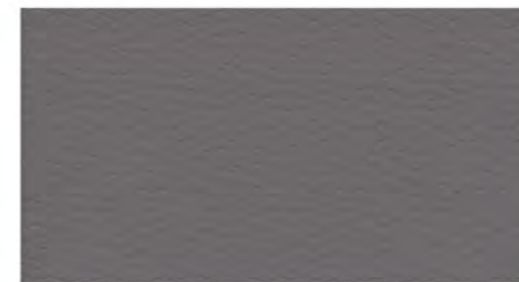

ECO604



ECO315



ECO710



ECO313



ECO200

**Art Direction**

Tumidei Lab

**Concept & Graphic design**

Michela Boglietti

**Set designer**

Paola Citterio

**Immagini**

Studio Imergo

**Colour separation**

CD Cromo

**Print**

Modulgrafica

Printed in Italy 2020  
© 2020, TUMIDEI S.R.L.

Tutti i diritti riservati.  
Nessuna parte del presente catalogo  
può essere riprodotta o diffusa  
con un mezzo qualsiasi, fotocopie,  
microfilm o altro, senza il permesso  
del titolare del copyright.

*All rights reserved.  
No part of this catalogue may be  
reproduced or transmitted in any way,  
by photocopying, microfilm or else,  
without permission of the copyright holder.*

Le tonalità dei colori sono puramente  
indicative. Per verificare i toni reali consultare  
il campionario delle finiture Tumidei.

*Colours are approximate.  
In order to check the real shades,  
refer to Tumidei finishes samples.*

**TUMIDEI®**

S. Cassiano in Pennino 57/A - 47016 Predappio (FC) Italy  
T. +39 0543.921.076 r.a. - F. +39 0543.921.079  
info\_italia@tumidei.it - export@tumidei.it - www.tumidei.it

