

# SAVOY HOUSE ESSENTIALS



JUNE 2019





# Savoy House COLLECTIONS...

These Savoy House Lighting collections fulfill our design mission of creating recognizable and stylish products. We also continue our tradition of matching extraordinary design with great value, creating excitement and satisfaction with our lighting.

Along with our passion for great design is our commitment to quality engineering and high production standards.

Savoy House Lighting products undergo countless inspections and rigid testing, all performed by a highly trained and competent staff of inspectors and product specialists, before leaving the factory. Marvelous design, superior quality standards and notable value are all things our clients have come to expect from Savoy House since we were founded in 1965.

Our hope is that Savoy House Lighting's merchandise and exemplary service will make the demands of your job a lot easier. This commitment we have extends not only to our design and quality, but to you, our valued customers.

As always, we thank you for our continued growth, which is made possible through your kind and loyal support.



# CONTENTS

ALPHABETICAL LISTING *by* FAMILY:

---

Abbott .....	4	Lacey.....	129
Akron .....	94	Lilly .....	84
Alden.....	108	Lucerne.....	136
Ashmont .....	112	Magnum.....	92
Austin.....	110	Marly .....	74
Avalon.....	122	Mayfield.....	117
Bally.....	121	Melrose.....	180
Benton.....	134	Merrill.....	160
Braxton .....	82	Middleton .....	26
Calhoun .....	178	Monroe.....	146
Chaplin.....	152	Morland .....	164
Chatham.....	54	Octave.....	58, 119, 126, 170
Clifton .....	159	Payton.....	154
Dakota .....	166	Penrose.....	102
Dash.....	96	Pike.....	158
Delaney .....	168	Prescott.....	18
Denton .....	50	Rotterdam .....	20
Destin.....	150	Rutland.....	142
Drake.....	118, 167, 174	Shane .....	114
Drummond .....	128	Sherrill.....	130
Dumont .....	76	Stirling .....	88
Dunbar .....	68	Townsend.....	36
Epsilon.....	90	Walpole .....	124
Franklin.....	120	Washburn.....	156
Galea .....	72	Watkins .....	132
Garrett.....	98	Waverly.....	144
Garvey .....	116	Westbourne.....	86
Glenn.....	162	William.....	78
Hayden.....	8	Windham .....	12



# CONTENTS



Collections ..... 4



Flush Mounts / Semi-Flush ..... 122



Wall Lighting ..... 142



Pour Le Bain / Bath ..... 168

*Index / Finish Guide* ..... 184

# ABBOTT

A. **7-8401-4-89**  
4-Light Pendant  
Matte Black Finish  
21-3/4"W x 8"H  
Adj H 8" - 128"  
4E 60W  
White Fabric Shade

B. **1-8400-8-89**  
8-Light Linear Chandelier  
Matte Black Finish  
44"L x 14-3/4"W x 9"H  
Adj H 9" - 129"  
8E 60W  
White Fabric Shade



A.



B.



# ABBOTT

---





# ABBOTT

A.



A. **7-8401-4-SN**  
4-Light Pendant  
Satin Nickel Finish  
21-3/4"W x 8"H  
Adj H 8" - 128"  
4E 60W  
White Fabric Shade

B. **1-8400-8-SN**  
8-Light Linear Chandelier  
Satin Nickel Finish  
44"L x 14-3/4"W x 9"H  
Adj H 9" - 129"  
8E 60W  
White Fabric Shade

B.



# HAYDEN



**A. 7-8501-5-89**  
5-Light Pendant  
Matte Black Finish  
25"W x 10-1/4"H  
Adj H 10-1/4" - 64-1/4"  
5E 60W  
30° Swivel  
White Fabric Shade

**B. 6-8502-3-89**  
3-Light Convertible  
Semi-Flush/Pendant  
Matte Black Finish  
15"W x 5-1/4"H  
Adj H 5-1/4" - 59-1/4"  
3E 60W  
30° Swivel  
White Fabric Shade

**C. 1-8500-5-89**  
5-Light Linear Chandelier  
Matte Black Finish  
42"L x 13-1/2"W x 10-1/4"H  
Adj H 10-1/4" - 64-1/4"  
5E 60W  
30° Swivel  
White Fabric Shade

# HAYDEN



\*B.

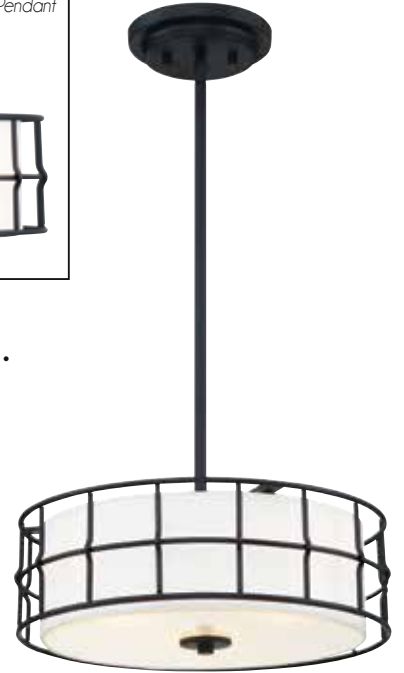

  
BRIAN THOMAS  
COLLECTION

\*\*C.



\*Options: 7-EXT-BK Extension Rod - 9-1/2"

\*\*Options: 7-EXTLG-BK Extension Rod - 12"



# HAYDEN



\*A.



\*\*B.



\*\*C.

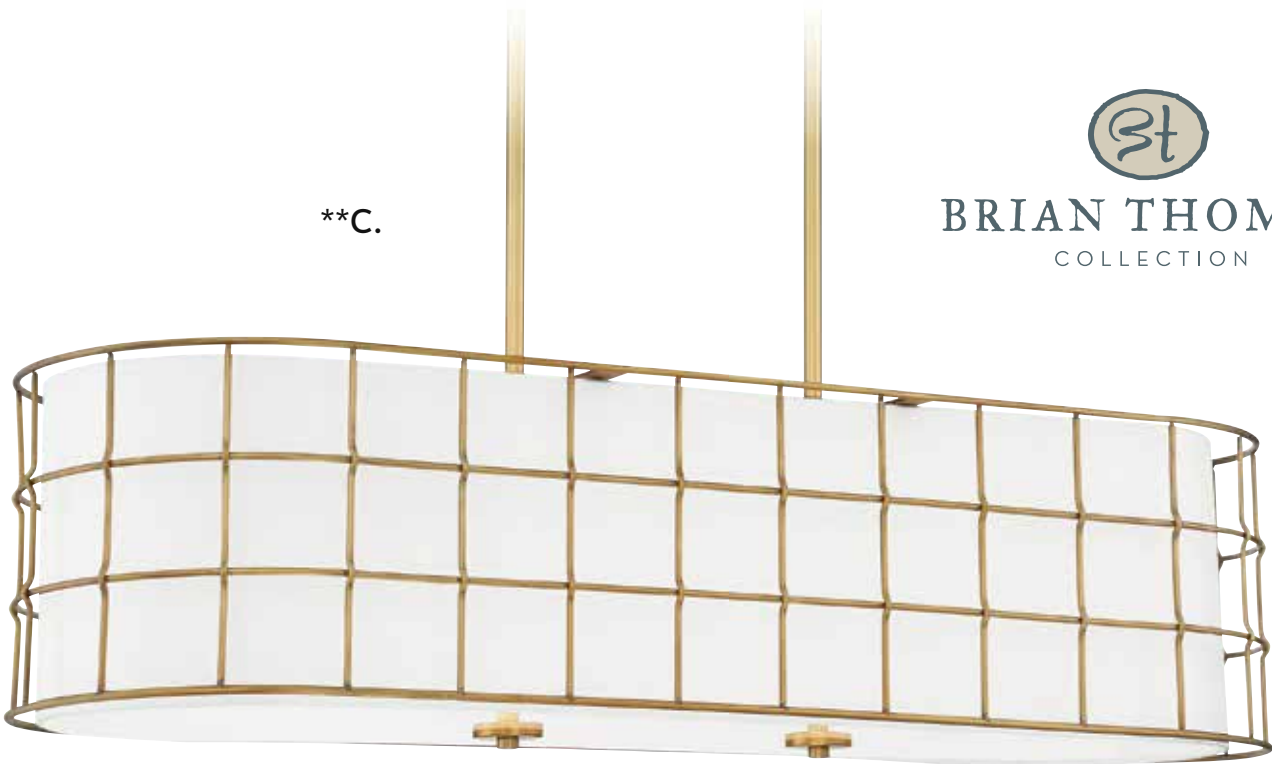

**BRIAN THOMAS**  
COLLECTION

\*Options: 7-EXT-322 Extension Rod - 9-1/2"

\*\*Options: 7-EXTLG-322 Extension Rod - 12"



**A. 6-8502-3-322**  
 3-Light Convertible  
 Semi-Flush/Pendant  
 Warm Brass Finish  
 15"W x 5-1/4"H  
 Adj H 5-1/4" - 59-1/4"  
 3E 60W  
 30° Swivel  
 White Fabric Shade

**B. 7-8501-5-322**  
 5-Light Pendant  
 Warm Brass Finish  
 25"W x 10-1/4"H  
 Adj H 10-1/4" - 64-1/4"  
 5E 60W  
 30° Swivel  
 White Fabric Shade

**C. 1-8500-5-322**  
 5-Light Linear Chandelier  
 Warm Brass Finish  
 42"L x 13-1/2"W x 10-1/4"H  
 Adj H 10-1/4" - 64-1/4"  
 5E 60W  
 30° Swivel  
 White Fabric Shade

# WINDHAM



- A. 7-8701-6-322**  
6-Light Pendant  
Warm Brass Finish  
28"W x 28"H  
6C 60W  
Clear Crystal
- B. 7-8700-4-322**  
4-Light Pendant  
Warm Brass Finish  
20"W x 22"H  
4C 60W  
Clear Crystal
- C. 1-8702-8-322**  
8-Light Linear Chandelier  
Warm Brass Finish  
38"L x 16"W x 26"H  
8C 60W  
Clear Crystal

# WINDHAM

A.



B.

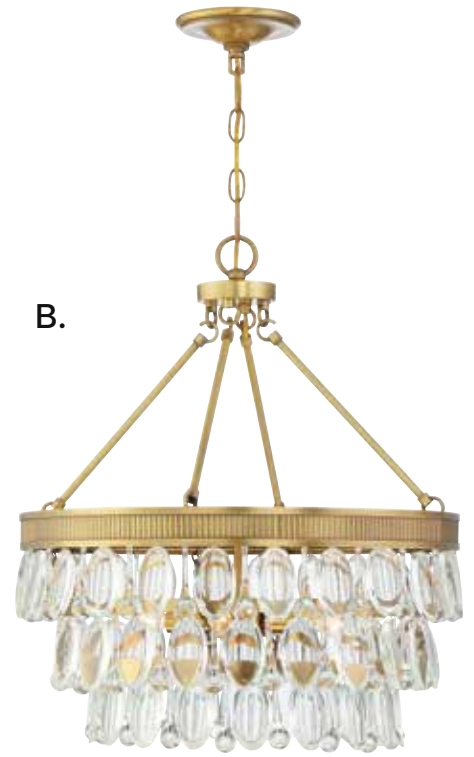

C.



# WINDHAM



- A. 7-8701-6-109**  
6-Light Pendant  
Polished Nickel Finish  
28"W x 28"H  
6C 60W  
Clear Crystal
- B. 7-8700-4-109**  
4-Light Pendant  
Polished Nickel Finish  
20"W x 22"H  
4C 60W  
Clear Crystal
- C. 1-8702-8-109**  
8-Light Linear Chandelier  
Polished Nickel Finish  
38"L x 16"W x 26"H  
8C 60W  
Clear Crystal



# WINDHAM

A.



B.

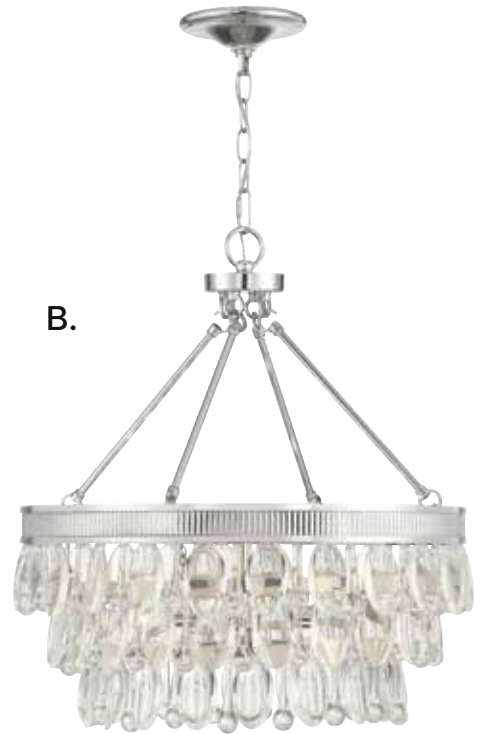

C.



# WINDHAM

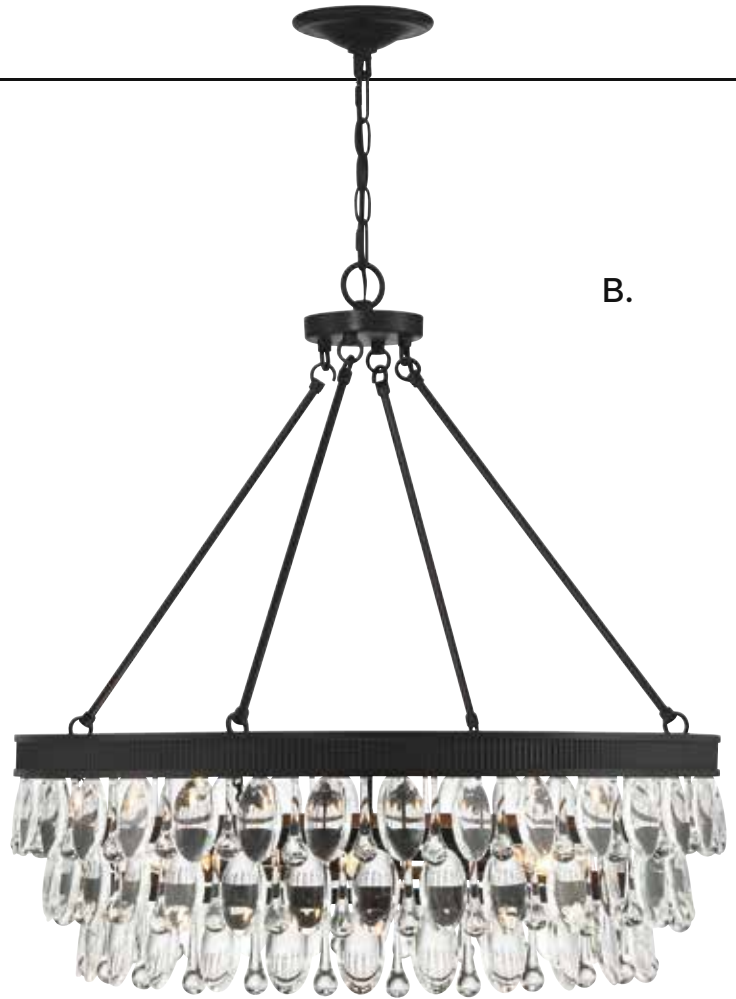

# WINDHAM



- A. 7-8700-4-13**  
4-Light Pendant  
English Bronze Finish  
20"W x 22"H  
4C 60W  
Clear Crystal
- B. 7-8701-6-13**  
6-Light Pendant  
English Bronze Finish  
28"W x 28"H  
6C 60W  
Clear Crystal
- C. 1-8702-8-13**  
8-Light Linear Chandelier  
English Bronze Finish  
38"L x 16"W x 26"H  
8C 60W  
Clear Crystal

# PRESCOTT



**A.**



**B.**

- |  |   |  |  |   |   |
|--|---|--|--|---|---|
| <b>A. 9-0601-1-SN</b><br>1-Light Sconce<br>Satin Nickel Finish<br>6-1/2"W x 12-1/4"H<br>x 4-3/4"E<br>1E 60W<br>Clear Beveled Glass | <b>B. 9-0601-1-322</b><br>1-Light Sconce<br>Warm Brass Finish<br>6-1/2"W x 12-1/4"H<br>x 4-3/4"E<br>1E 60W<br>Clear Beveled Glass | <b>C. 1-0602-6-SN</b><br>6-Light Linear<br>Chandelier<br>Satin Nickel Finish<br>36"L x 8"W x 21"H<br>6E 60W<br>Clear Beveled Glass | <b>D. 7-0600-6-SN</b><br>6-Light Pendant<br>Satin Nickel Finish<br>28"W x 28"H<br>6C 60W<br>Clear Beveled Glass<br>Metal Candle Covers | <b>E. 1-0602-6-322</b><br>6-Light Linear<br>Chandelier<br>Warm Brass Finish<br>36"L x 8"W x 21"H<br>6E 60W<br>Clear Beveled Glass | <b>F. 7-0600-6-322</b><br>6-Light Pendant<br>Warm Brass Finish<br>28"W x 28"H<br>6C 60W<br>Clear Beveled Glass<br>Metal Candle Covers |
|--|---|--|--|---|---|

# PRESCOTT

C.



D.



E.

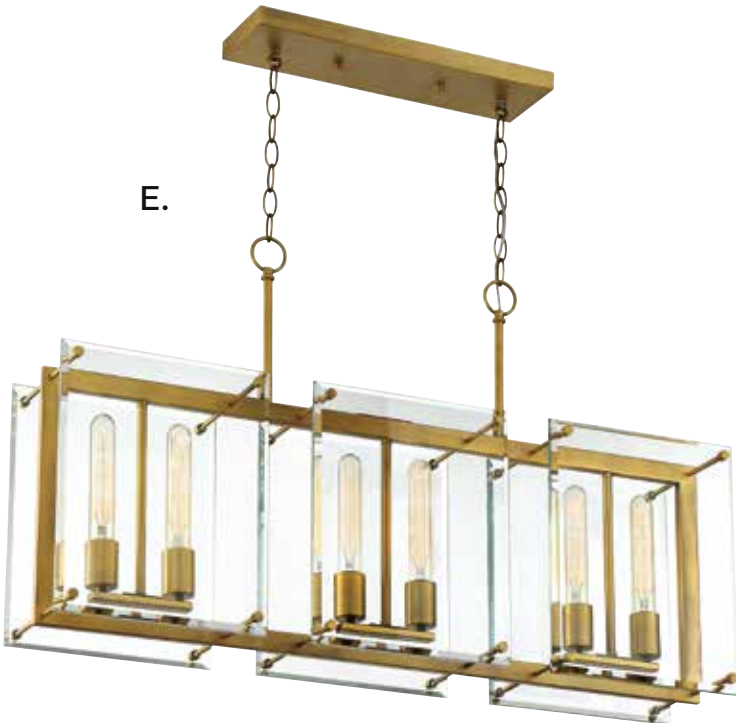

F.



# ROTTERDAM



**A. 6-1662-4-322**  
4-Light Convertible  
Semi-Flush/Pendant  
Warm Brass Finish  
20"W x 18"H  
Adj H 18" - 75"  
4C 60W  
30° Swivel  
Optic Acrylic Elements  
Metal Candle Covers

**B. 7-1661-6-322**  
6-Light Pendant  
Warm Brass Finish  
20"L x 20"W x 25-1/2"H  
Adj H 25-1/2" - 82-1/2"  
6C 60W  
30° Swivel  
Optic Acrylic Elements  
Metal Candle Covers

**C. 7-1660-6-322**  
6-Light Pendant  
Warm Brass Finish  
31-1/2"L x 24-3/4"W x 20-1/2"H  
Adj H 20-1/2" - 77-1/2"  
6C 60W  
30° Swivel  
Optic Acrylic Elements  
Metal Candle Covers

# ROTTERDAM

\*A.

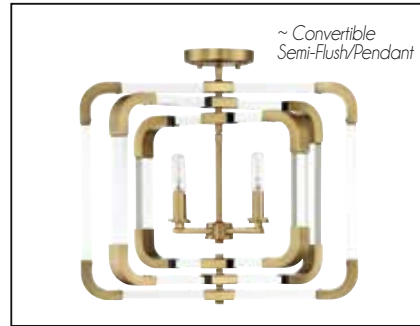
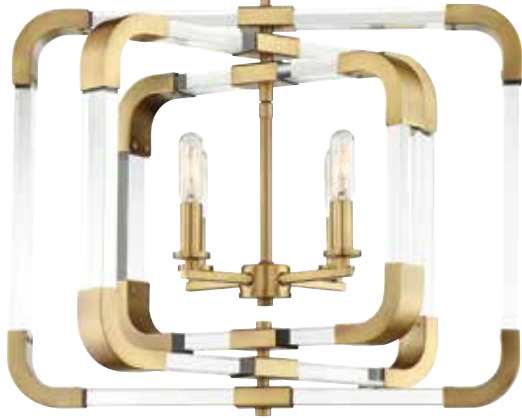

BRIAN THOMAS  
COLLECTION

\*\*B.

\*Options: 7-EXT-322 Extension Rod - 9-1/2"



\*\*C.



\*\*Options: 7-EXTLG-322 Extension Rod - 12"

\*\*\*The rings of the Rotterdam Collection are adjustable and can rotate into different positions.



Linear Chandelier, Page 25

# ROTTERDAM



**A. 6-1662-4-109**

4-Light Convertible  
Semi-Flush/Pendant  
Polished Nickel Finish  
20"W x 18"H  
Adj H 18" - 75"  
4C 60W  
30° Swivel  
Optic Acrylic Elements  
Metal Candle Covers

**B. 7-1661-6-109**

6-Light Pendant  
Polished Nickel Finish  
20"L x 20"W x 25-1/2"H  
Adj H 25-1/2" - 82-1/2"  
6C 60W  
30° Swivel  
Optic Acrylic Elements  
Metal Candle Covers

**C. 7-1660-6-109**

6-Light Pendant  
Polished Nickel Finish  
31-1/2"L x 24-3/4"W x 20-1/2"H  
Adj H 20-1/2" - 77-1/2"  
6C 60W  
30° Swivel  
Optic Acrylic Elements  
Metal Candle Covers



# ROTTERDAM

\*A.

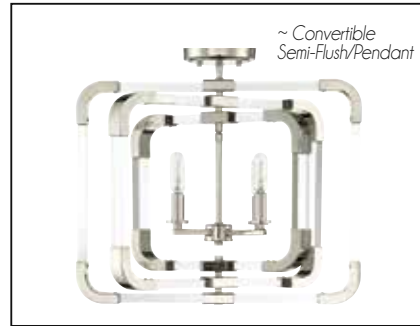

BRIAN THOMAS  
COLLECTION

\*\*B.

\*Options: 7-EXT-109 Extension Rod - 9-1/2"



\*\*C.



\*\*Options: 7-EXTLG-109 Extension Rod - 12"

\*\*\*The rings of the Rotterdam Collection are adjustable and can rotate into different positions.

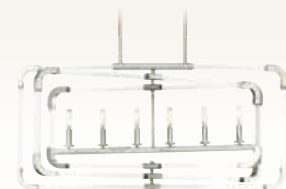

Linear Chandelier, Page 25

# ROTTERDAM

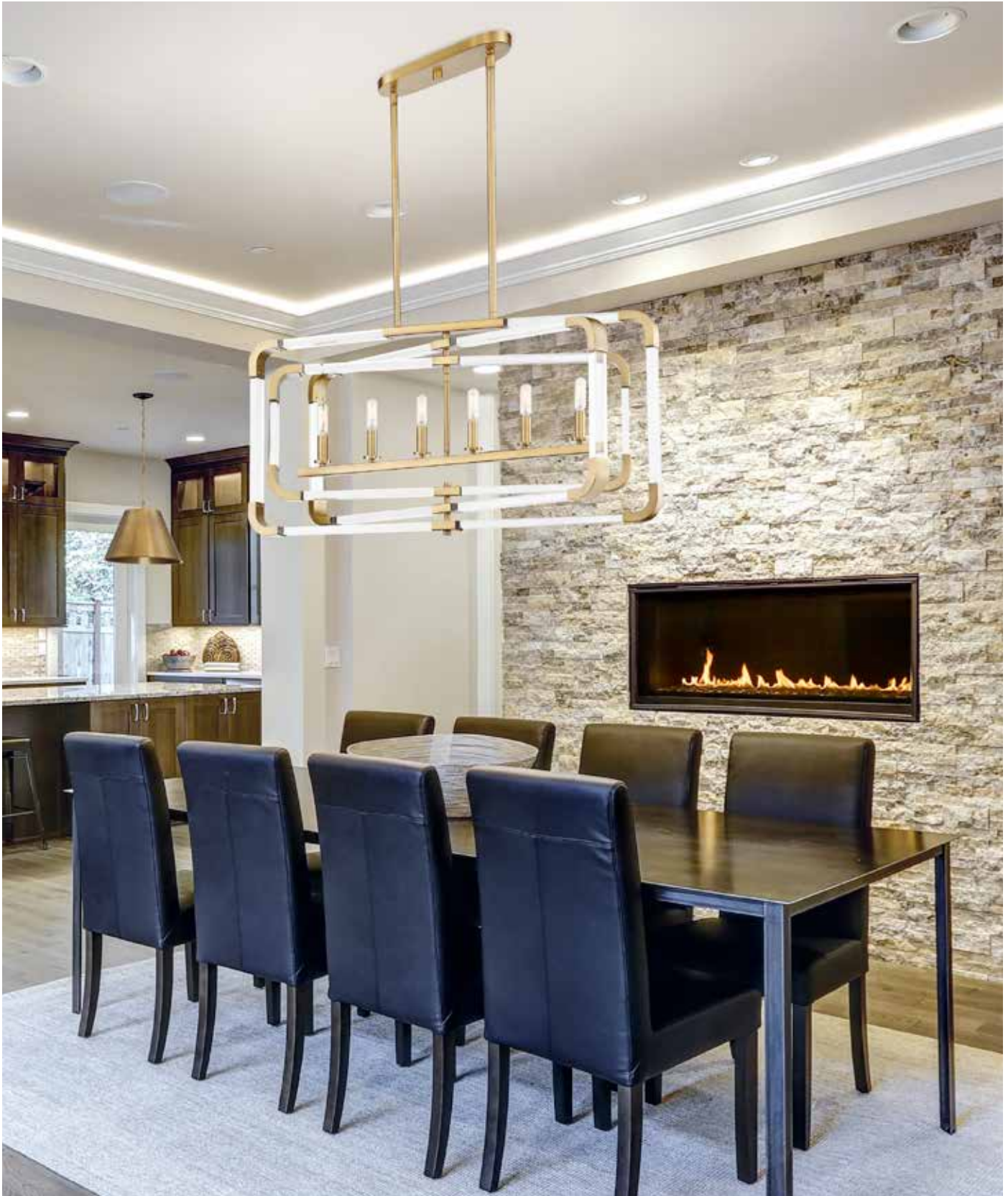

# ROTTERDAM

## A. 1-1663-6-109

6-Light Linear Chandelier  
Polished Nickel Finish  
37"W x 18"H  
Adj H 18" - 75"  
6C 60W  
30° Swivel  
Optic Acrylic Elements  
Metal Candle Covers

\*A.

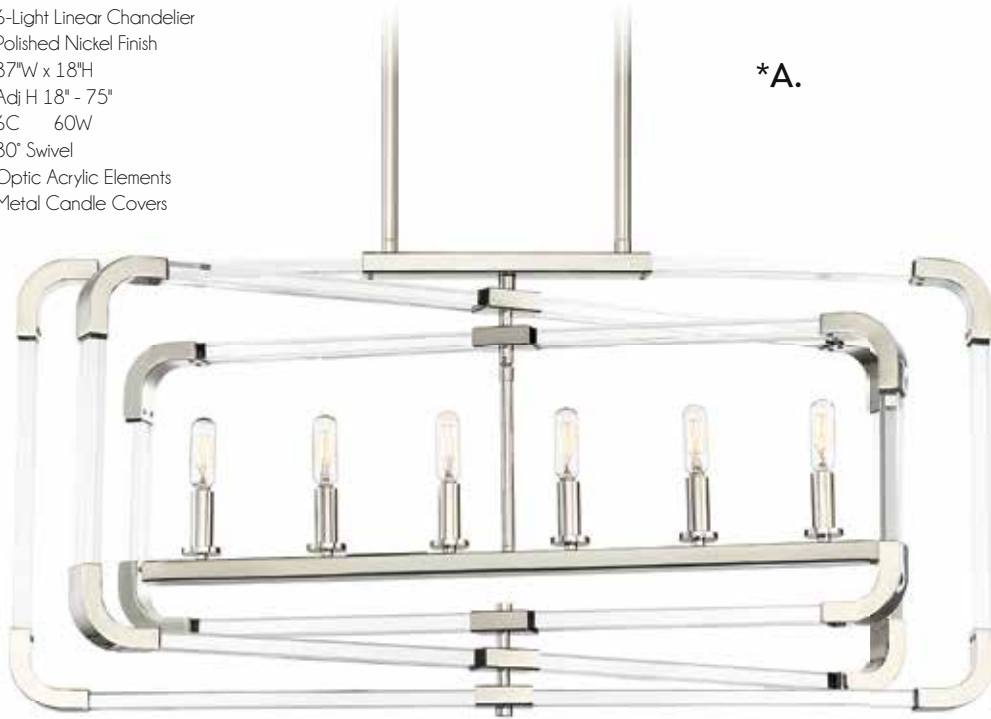

\*\*\*The rings of the Rotterdam Collection are adjustable and can rotate into different positions.

\*Options: 7-EXTLG-109 Extension Rod - 12"

## B. 1-1663-6-322

6-Light Linear Chandelier  
Warm Brass Finish  
37"W x 18"H  
Adj H 18" - 75"  
6C 60W  
30° Swivel  
Optic Acrylic Elements  
Metal Candle Covers



BRIAN THOMAS  
COLLECTION

\*\*B.

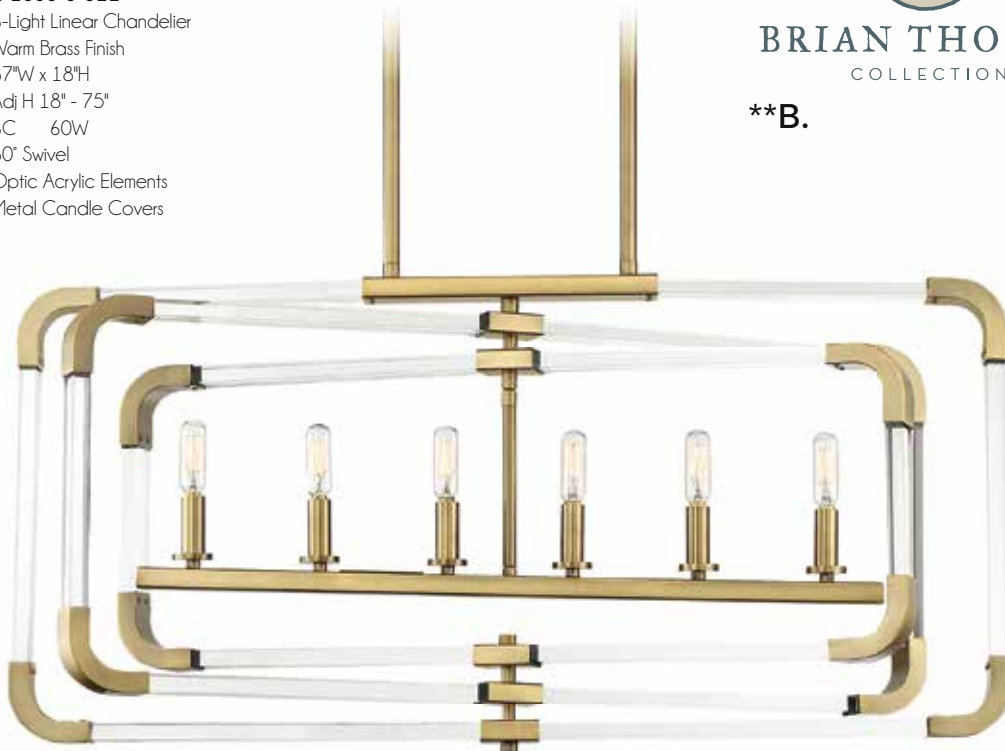

\*\*\*The rings of the Rotterdam Collection are adjustable and can rotate into different positions.

\*\*Options: 7-EXTLG-322 Extension Rod - 12"



# MIDDLETON



**A. 1-307-6-89**

6-Light Chandelier  
Matte Black Finish  
25"W x 23"H  
6C 60W  
Metal Candle Covers

**B. 1-307-6-109**

6-Light Chandelier  
Polished Nickel Finish  
25"W x 23"H  
6C 60W  
Metal Candle Covers

**C. 1-307-6-322**

6-Light Chandelier  
Warm Brass Finish  
25"W x 23"H  
6C 60W  
Metal Candle Covers

**D. 1-307-6-SN**

6-Light Chandelier  
Satin Nickel Finish  
25"W x 23"H  
6C 60W  
Metal Candle Covers

**E. 1-307-6-44**

6-Light Chandelier  
Classic Bronze Finish  
25"W x 23"H  
6C 60W  
Metal Candle Covers

# MIDDLETON

A.

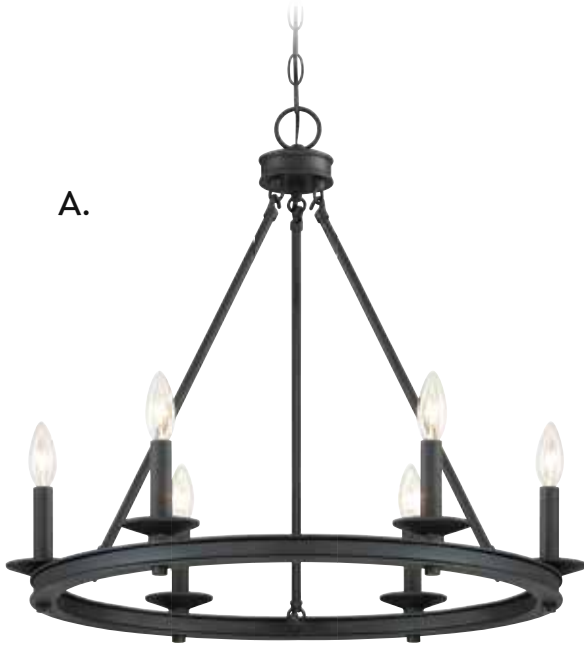

B.



48h\*

C.



D.



48h\*

E.



# MIDDLETON

---

A.

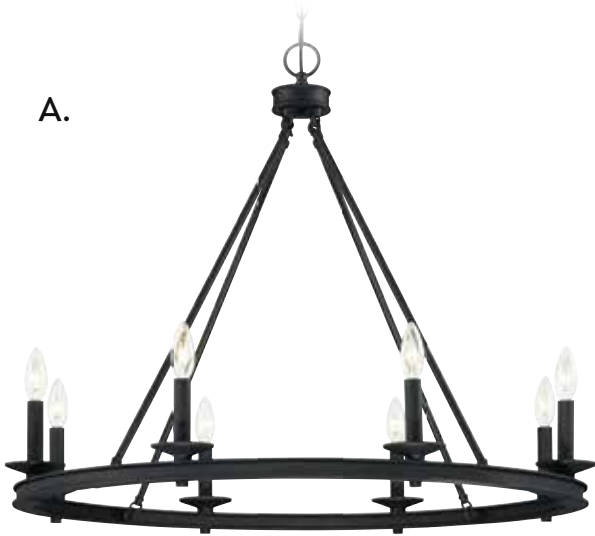

B.

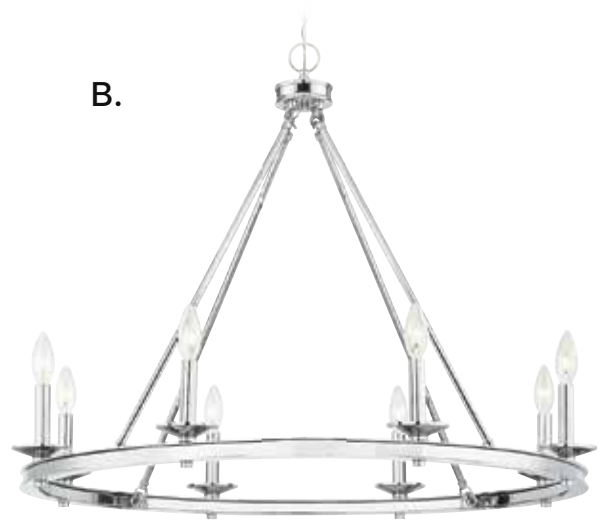

C.

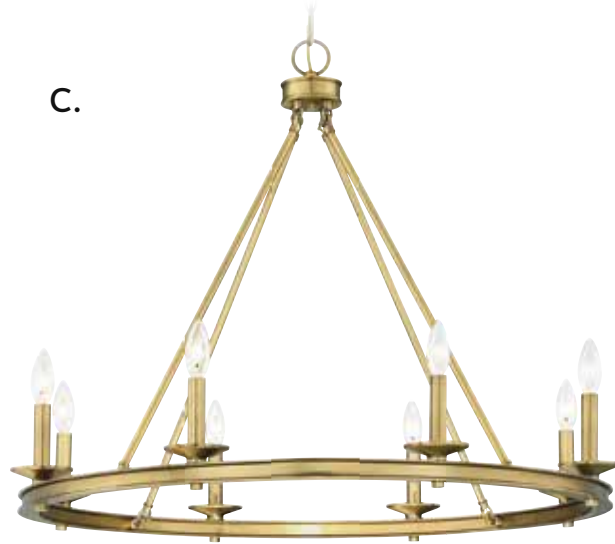

D.

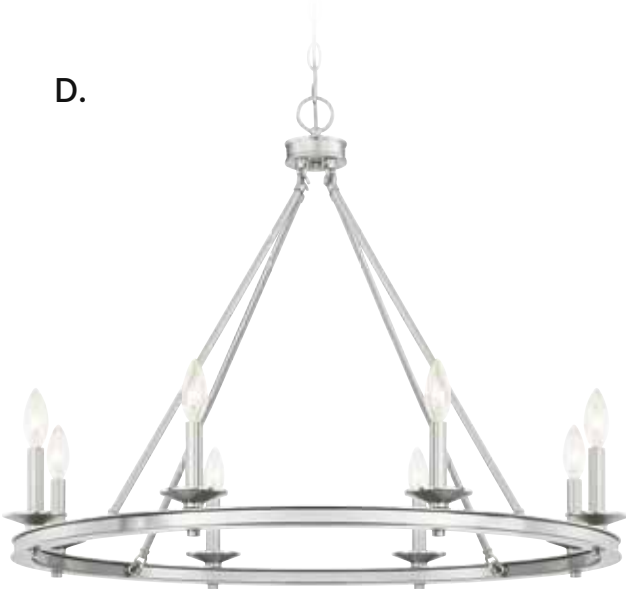

E.

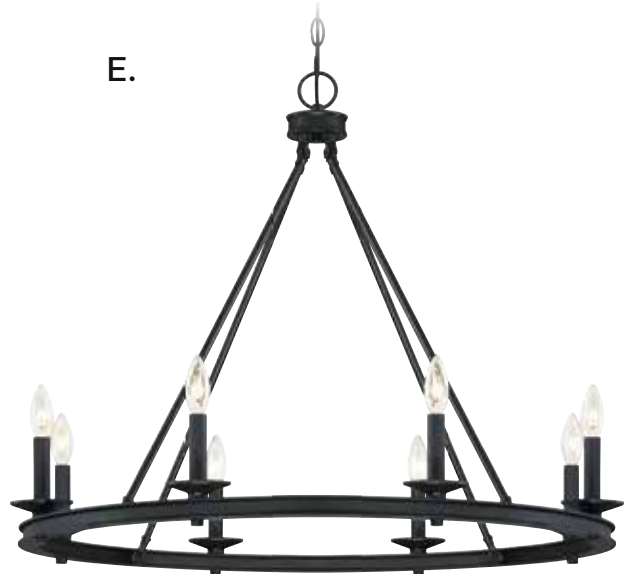

# MIDDLETON



**A. 1-308-8-89**  
8-Light Chandelier  
Matte Black Finish  
33"W x 25"H  
8C 60W  
Metal Candle Covers

**B. 1-308-8-109**  
8-Light Chandelier  
Polished Nickel Finish  
33"W x 25"H  
8C 60W  
Metal Candle Covers

**C. 1-308-8-322**  
8-Light Chandelier  
Warm Brass Finish  
33"W x 25"H  
8C 60W  
Metal Candle Covers

**D. 1-308-8-SN**  
8-Light Chandelier  
Satin Nickel Finish  
33"W x 25"H  
8C 60W  
Metal Candle Covers

**E. 1-308-8-44**  
8-Light Chandelier  
Classic Bronze Finish  
33"W x 25"H  
8C 60W  
Metal Candle Covers

# MIDDLETON

A.

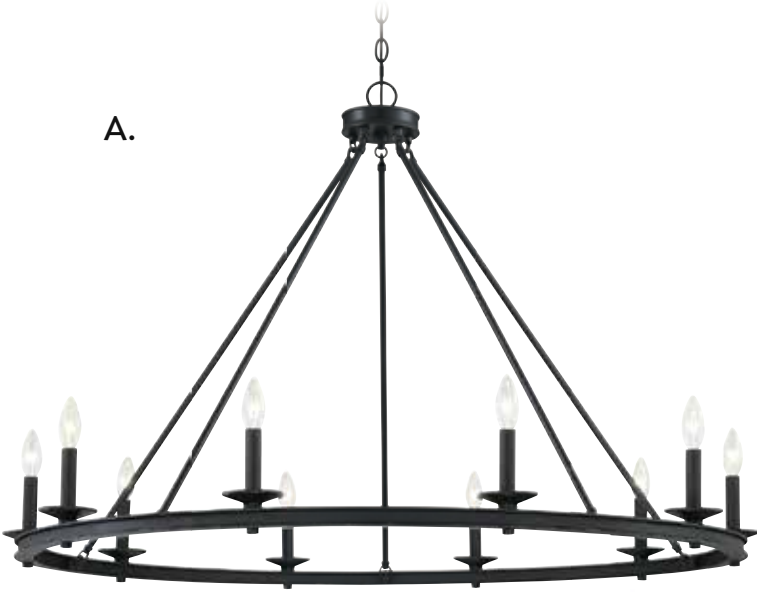

B.

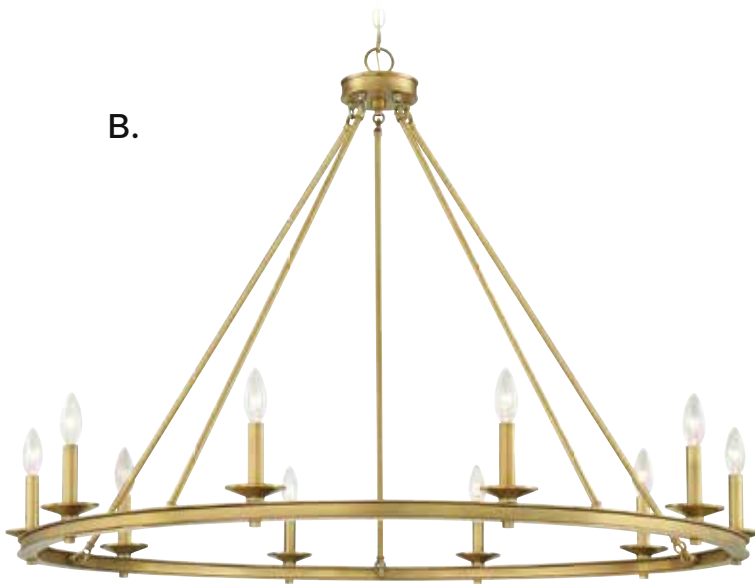

C.

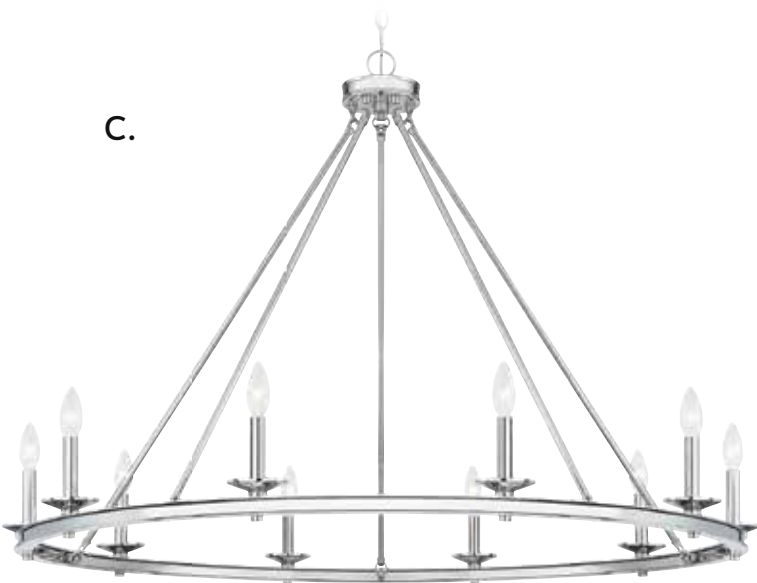



# MIDDLETON

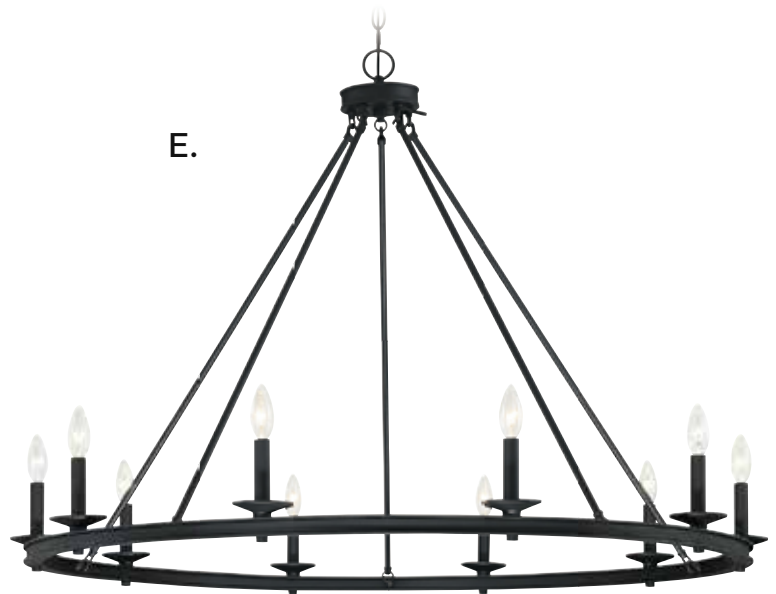
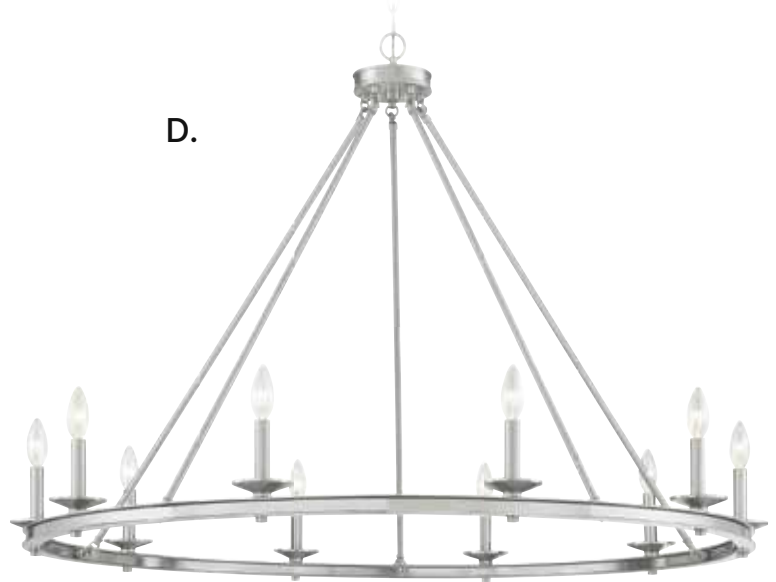

**A. 1-310-10-89**  
10-Light Chandelier  
Matte Black Finish  
45"W x 32-1/4"H  
10C 60W  
Metal Candle Covers

**B. 1-310-10-322**  
10-Light Chandelier  
Warm Brass Finish  
45"W x 32-1/4"H  
10C 60W  
Metal Candle Covers

**C. 1-310-10-109**  
10-Light Chandelier  
Polished Nickel Finish  
45"W x 32-1/4"H  
10C 60W  
Metal Candle Covers

**D. 1-310-10-SN**  
10-Light Chandelier  
Satin Nickel Finish  
45"W x 32-1/4"H  
10C 60W  
Metal Candle Covers

**E. 1-310-10-44**  
10-Light Chandelier  
Classic Bronze Finish  
45"W x 32-1/4"H  
10C 60W  
Metal Candle Covers

# MIDDLETON

---



# MIDDLETON

A.



A. 1-312-15-89  
15-Light Chandelier  
Matte Black Finish  
45"W x 42"H  
15C 60W  
Metal Candle Covers

# MIDDLETON

---

A.

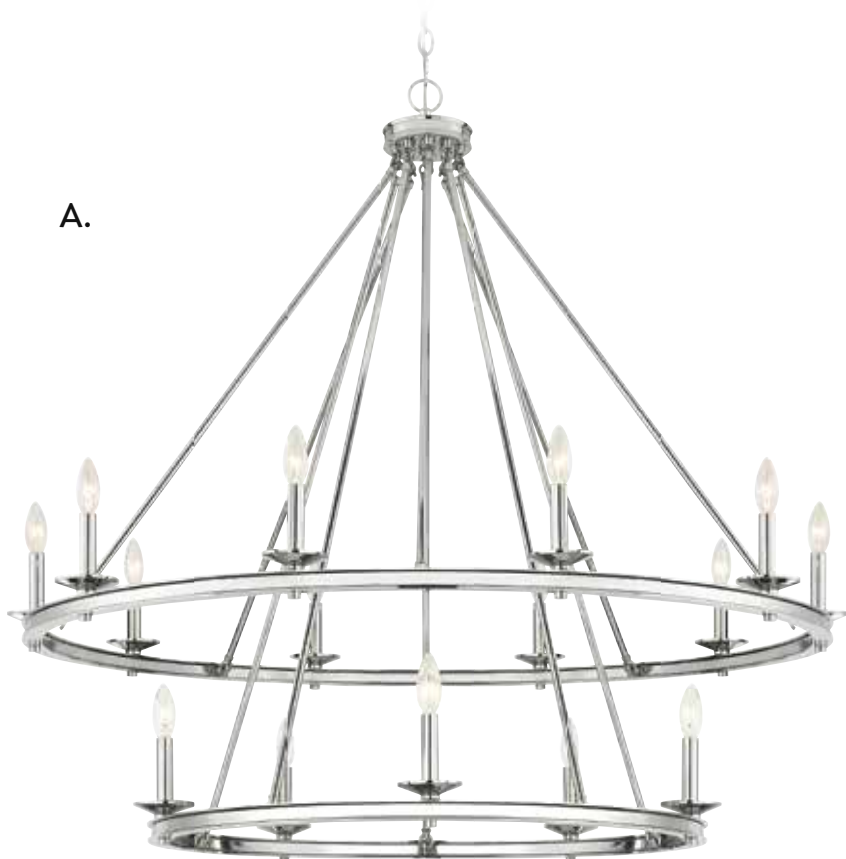

A. **1-312-15-109**  
15-Light Chandelier  
Polished Nickel Finish  
45"W x 42"H  
15C 60W  
Metal Candle Covers

B. **1-312-15-322**  
15-Light Chandelier  
Warm Brass Finish  
45"W x 42"H  
15C 60W  
Metal Candle Covers

C. **1-312-15-SN**  
15-Light Chandelier  
Satin Nickel Finish  
45"W x 42"H  
15C 60W  
Metal Candle Covers

D. **1-312-15-44**  
15-Light Chandelier  
Classic Bronze Finish  
45"W x 42"H  
15C 60W  
Metal Candle Covers

B.



C.



D.



# TOWNSEND

---

A.



B.

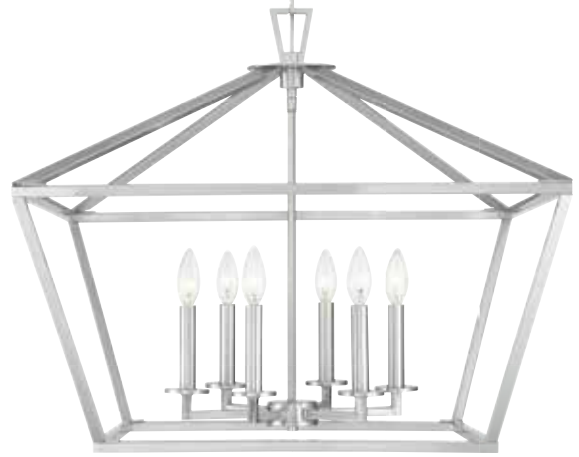

C.

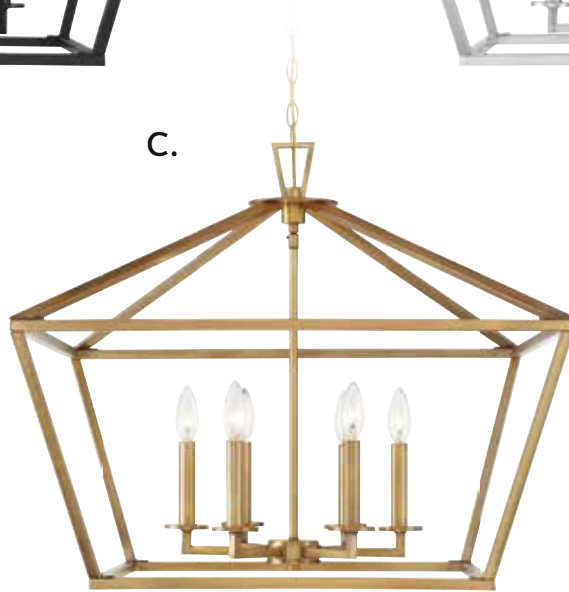

D.

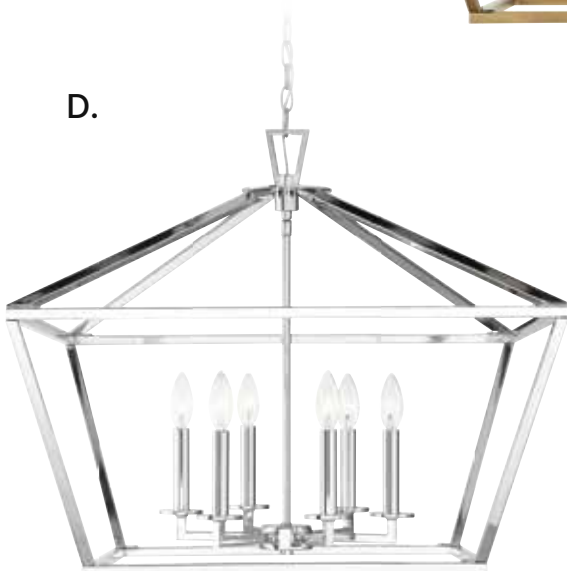

E.

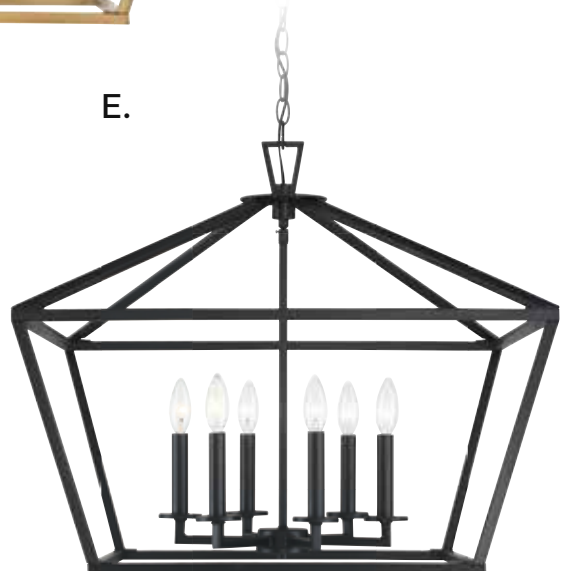

# TOWNSEND



**A. 3-325-6-44**  
6-Light Pendant  
Classic Bronze Finish  
26"W x 23-1/2"H  
6C 60W  
Metal Candle Covers

**B. 3-325-6-SN**  
6-Light Pendant  
Satin Nickel Finish  
26"W x 23-1/2"H  
6C 60W  
Metal Candle Covers

**C. 3-325-6-322**  
6-Light Pendant  
Warm Brass Finish  
26"W x 23-1/2"H  
6C 60W  
Metal Candle Covers

**D. 3-325-6-109**  
6-Light Pendant  
Polished Nickel Finish  
26"W x 23-1/2"H  
6C 60W  
Metal Candle Covers

**E. 3-325-6-89**  
6-Light Pendant  
Matte Black Finish  
26"W x 23-1/2"H  
6C 60W  
Metal Candle Covers

# TOWNSEND



**A. 3-320-3-44**  
3-Light Pendant  
Classic Bronze Finish  
10"W x 15"H  
3C 60W  
Metal Candle Covers

**B. 3-320-3-SN**  
3-Light Pendant  
Satin Nickel Finish  
10"W x 15"H  
3C 60W  
Metal Candle Covers

**C. 3-320-3-322**  
3-Light Pendant  
Warm Brass Finish  
10"W x 15"H  
3C 60W  
Metal Candle Covers

**D. 3-320-3-109**  
3-Light Pendant  
Polished Nickel Finish  
10"W x 15"H  
3C 60W  
Metal Candle Covers

**E. 3-320-3-89**  
3-Light Pendant  
Matte Black Finish  
10"W x 15"H  
3C 60W  
Metal Candle Covers



# TOWNSEND

A.



B.

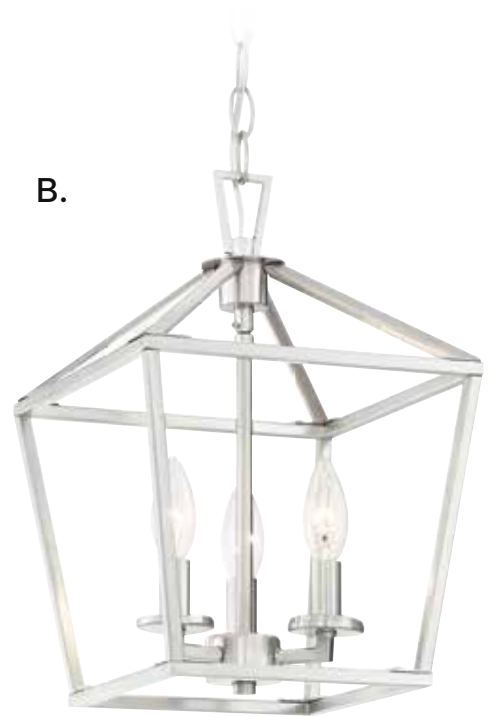

48h\*

C.



D.



E.



# TOWNSEND

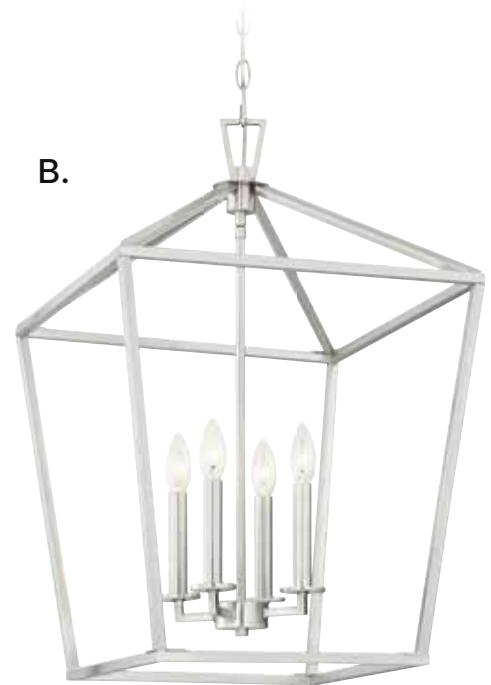

48h\*

C.

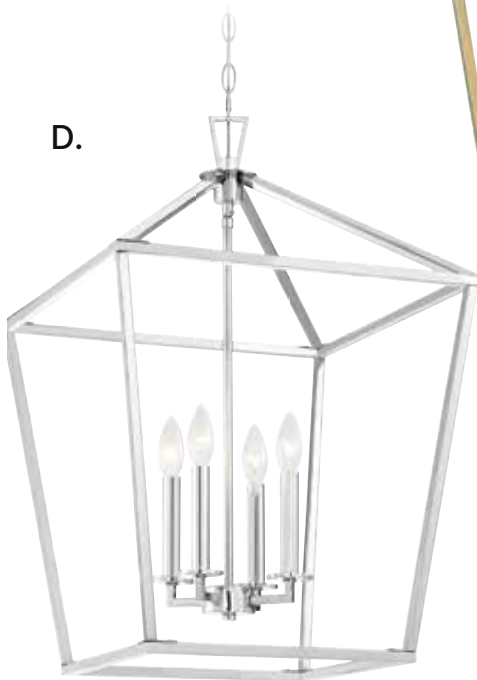
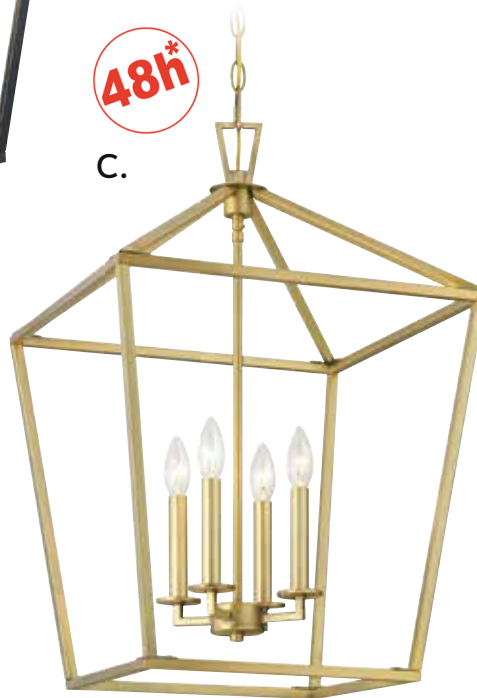

# TOWNSEND



**A. 3-321-4-44**  
4-Light Pendant  
Classic Bronze Finish  
17"W x 26"H  
4C 60W  
Metal Candle Covers

**B. 3-321-4-SN**  
4-Light Pendant  
Satin Nickel Finish  
17"W x 26"H  
4C 60W  
Metal Candle Covers

**C. 3-321-4-322**  
4-Light Pendant  
Warm Brass Finish  
17"W x 26"H  
4C 60W  
Metal Candle Covers

**D. 3-321-4-109**  
4-Light Pendant  
Polished Nickel Finish  
17"W x 26"H  
4C 60W  
Metal Candle Covers

**E. 3-321-4-89**  
4-Light Pendant  
Matte Black Finish  
17"W x 26"H  
4C 60W  
Metal Candle Covers

# TOWNSEND

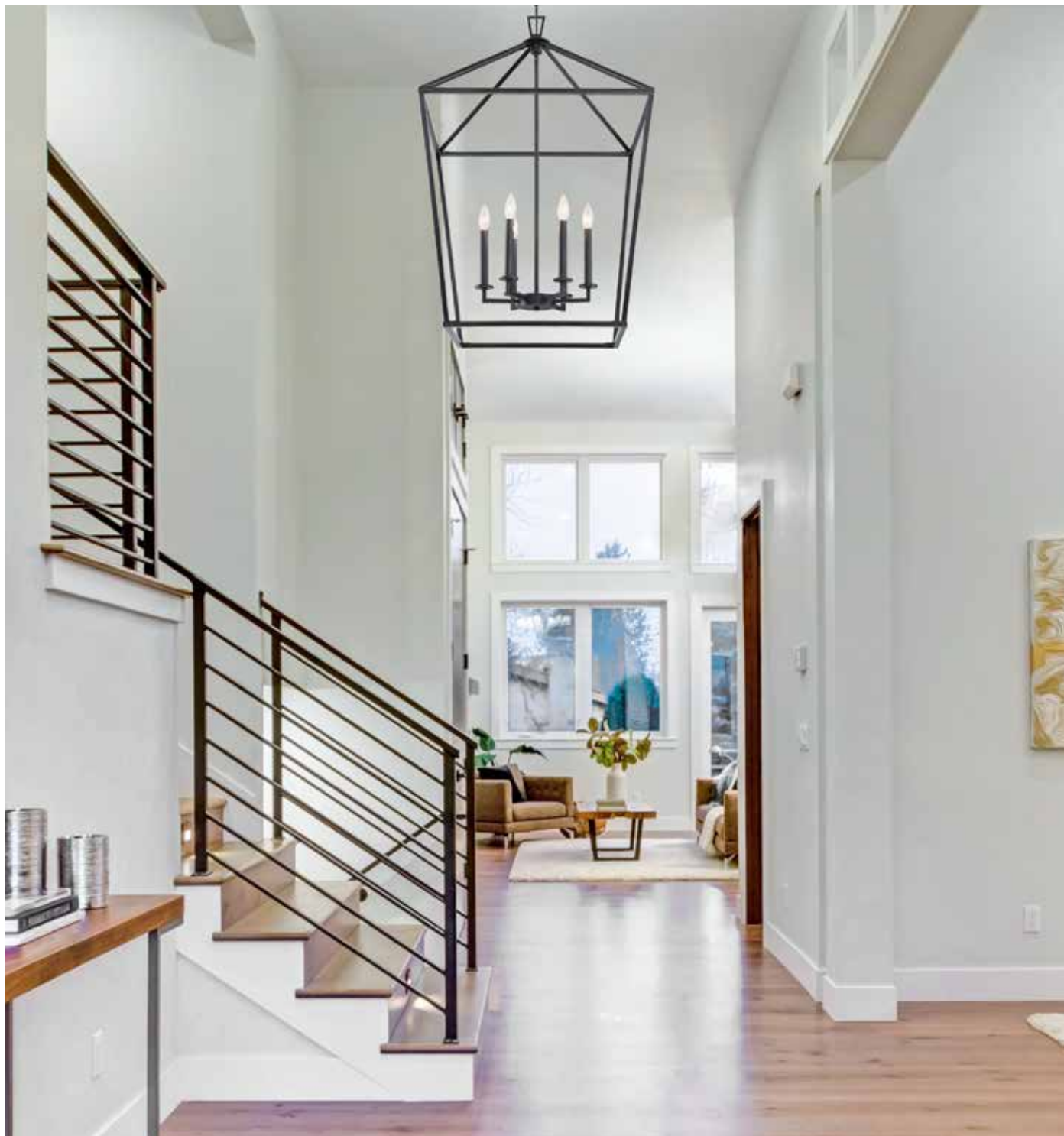

**A. 3-322-6-44**

6-Light Pendant  
Classic Bronze Finish  
24"W x 36-1/2"H  
6C 60W  
Metal Candle Covers

**B. 3-322-6-SN**

6-Light Pendant  
Satin Nickel Finish  
24"W x 36-1/2"H  
6C 60W  
Metal Candle Covers

**C. 3-322-6-322**

6-Light Pendant  
Warm Brass Finish  
24"W x 36-1/2"H  
6C 60W  
Metal Candle Covers

**D. 3-322-6-109**

6-Light Pendant  
Polished Nickel Finish  
24"W x 36-1/2"H  
6C 60W  
Metal Candle Covers

**E. 3-322-6-89**

6-Light Pendant  
Matte Black Finish  
24"W x 36-1/2"H  
6C 60W  
Metal Candle Covers

# TOWNSEND

A.

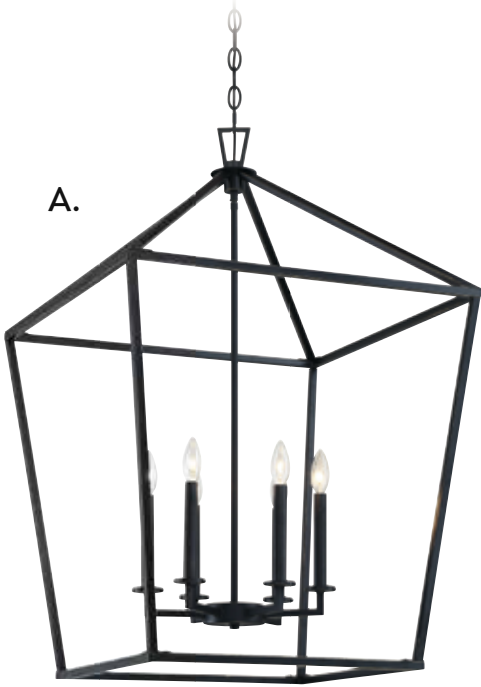

B.

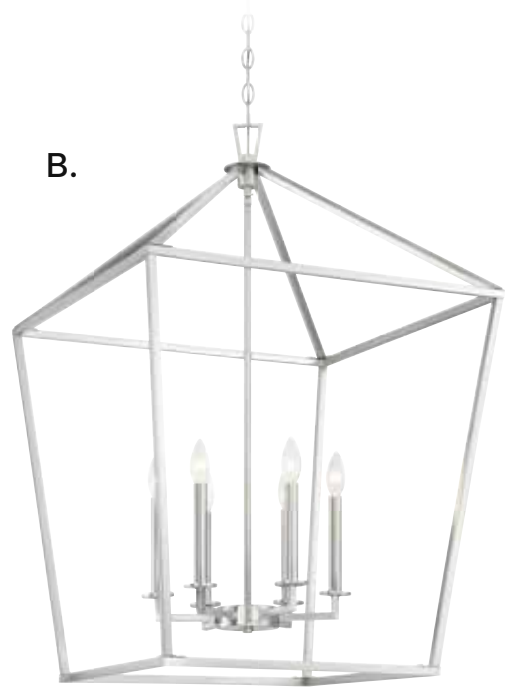

C.

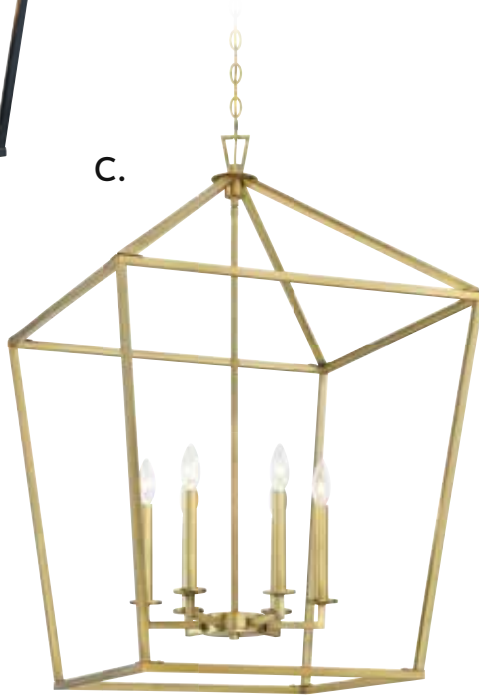

D.

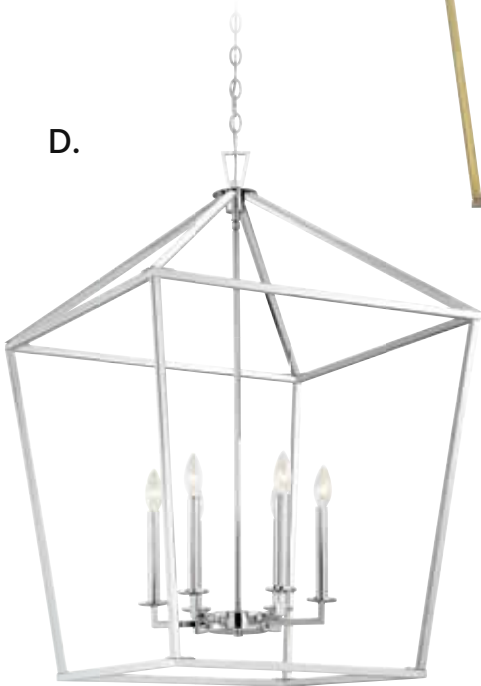

E.



# TOWNSEND

---

A.



B.



C.

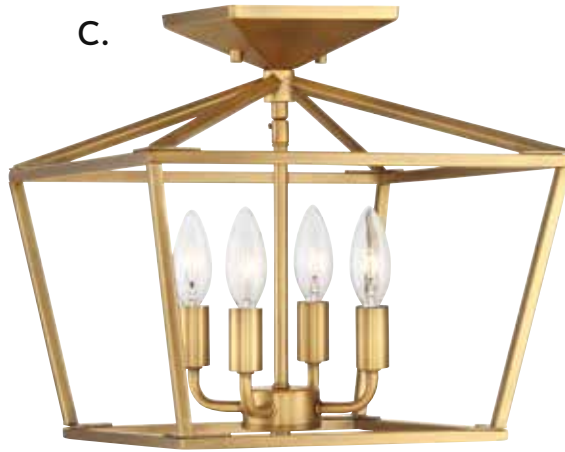

D.



E.



# TOWNSEND



**A. 6-328-4-44**  
4-Light Semi-Flush  
Classic Bronze Finish  
13"W x 13"H  
4C 60W  
Metal Candle Covers

**B. 6-328-4-SN**  
4-Light Semi-Flush  
Satin Nickel Finish  
13"W x 13"H  
4C 60W  
Metal Candle Covers

**C. 6-328-4-322**  
4-Light Semi-Flush  
Warm Brass Finish  
13"W x 13"H  
4C 60W  
Metal Candle Covers

**D. 6-328-4-109**  
4-Light Semi-Flush  
Polished Nickel Finish  
13"W x 13"H  
4C 60W  
Metal Candle Covers

**E. 6-328-4-89**  
4-Light Semi-Flush  
Matte Black Finish  
13"W x 13"H  
4C 60W  
Metal Candle Covers

# TOWNSEND



**A. 1-323-3-44**

3-Light Linear Chandelier  
Classic Bronze Finish  
32"L x 16"W x 21"H  
3C 60W  
Metal Candle Covers

**B. 1-323-3-SN**

3-Light Linear Chandelier  
Satin Nickel Finish  
32"L x 16"W x 21"H  
3C 60W  
Metal Candle Covers

**C. 1-323-3-322**

3-Light Linear Chandelier  
Warm Brass Finish  
32"L x 16"W x 21"H  
3C 60W  
Metal Candle Covers

**D. 1-323-3-109**

3-Light Linear Chandelier  
Polished Nickel Finish  
32"L x 16"W x 21"H  
3C 60W  
Metal Candle Covers

**E. 1-323-3-89**

3-Light Linear Chandelier  
Matte Black Finish  
32"L x 16"W x 21"H  
3C 60W  
Metal Candle Covers



# TOWNSEND

A.

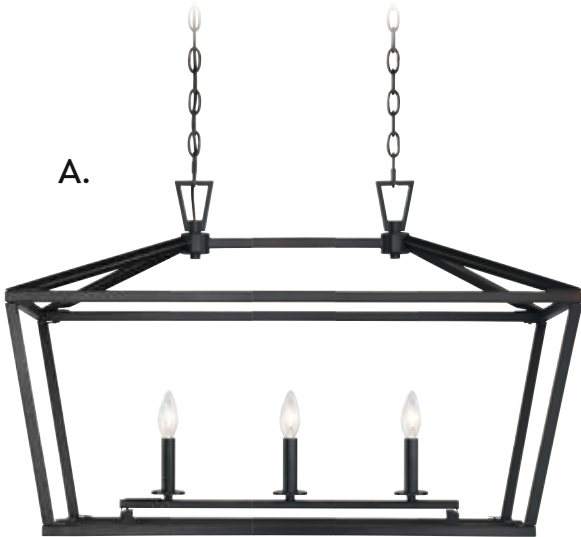

B.

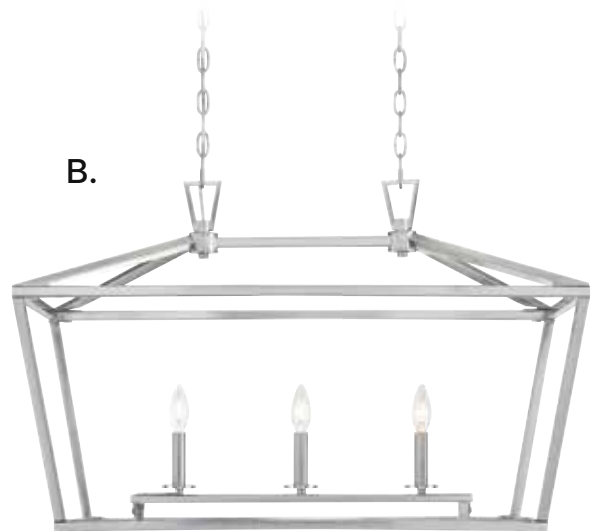

C.



D.

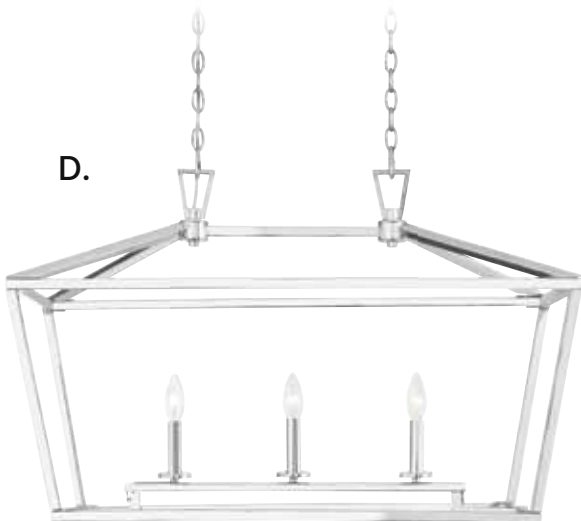

E.

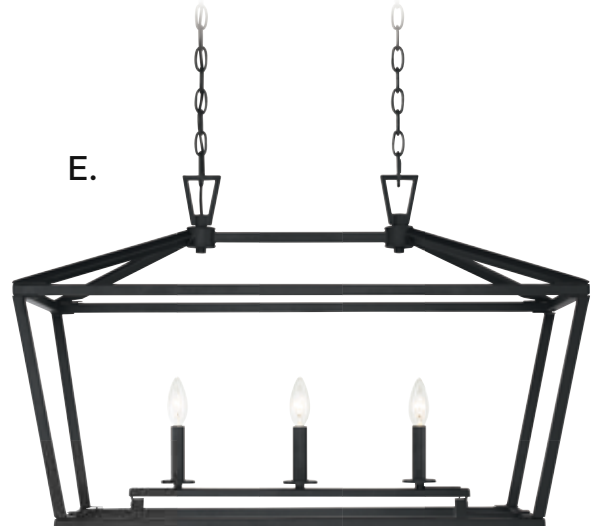

# TOWNSEND

---

A.

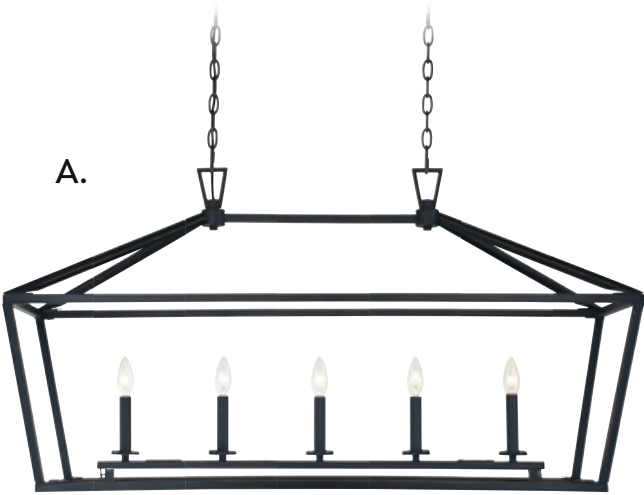

B.

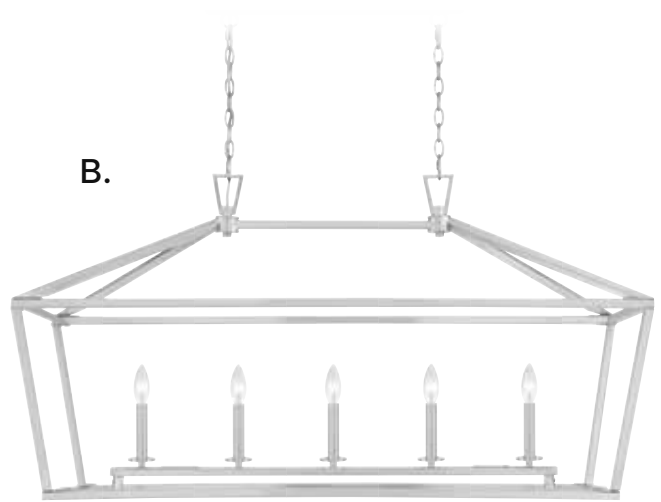

C.

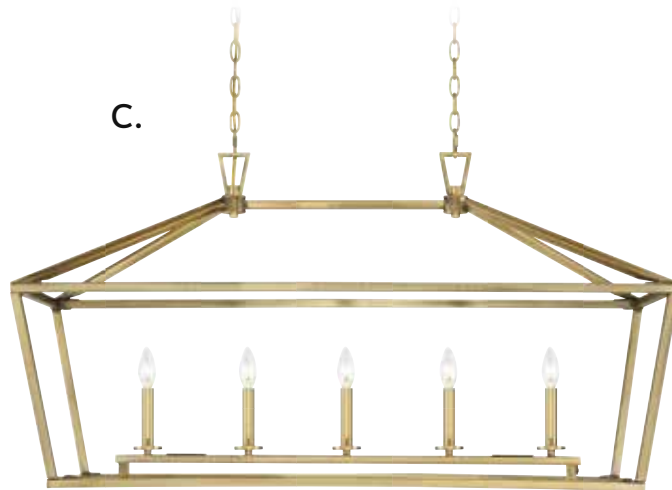

D.

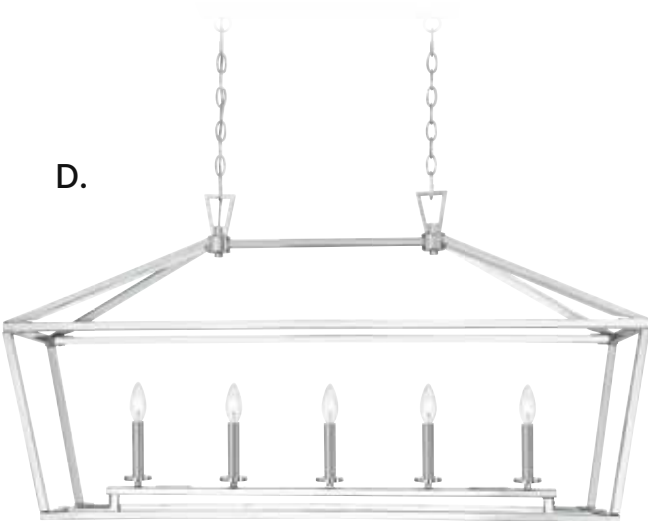

E.

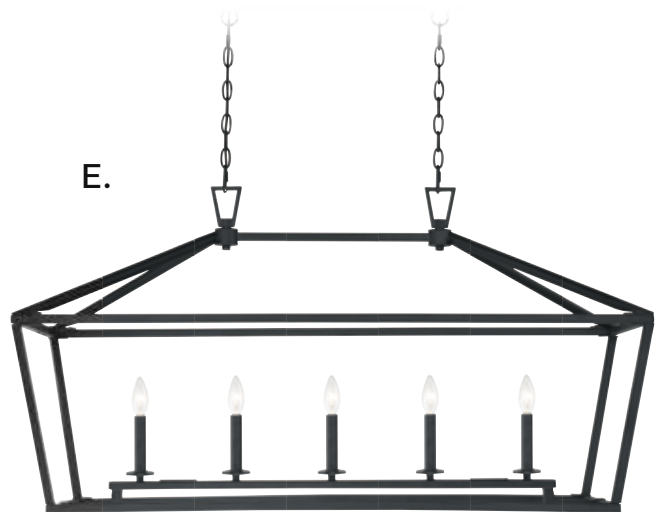

# TOWNSEND

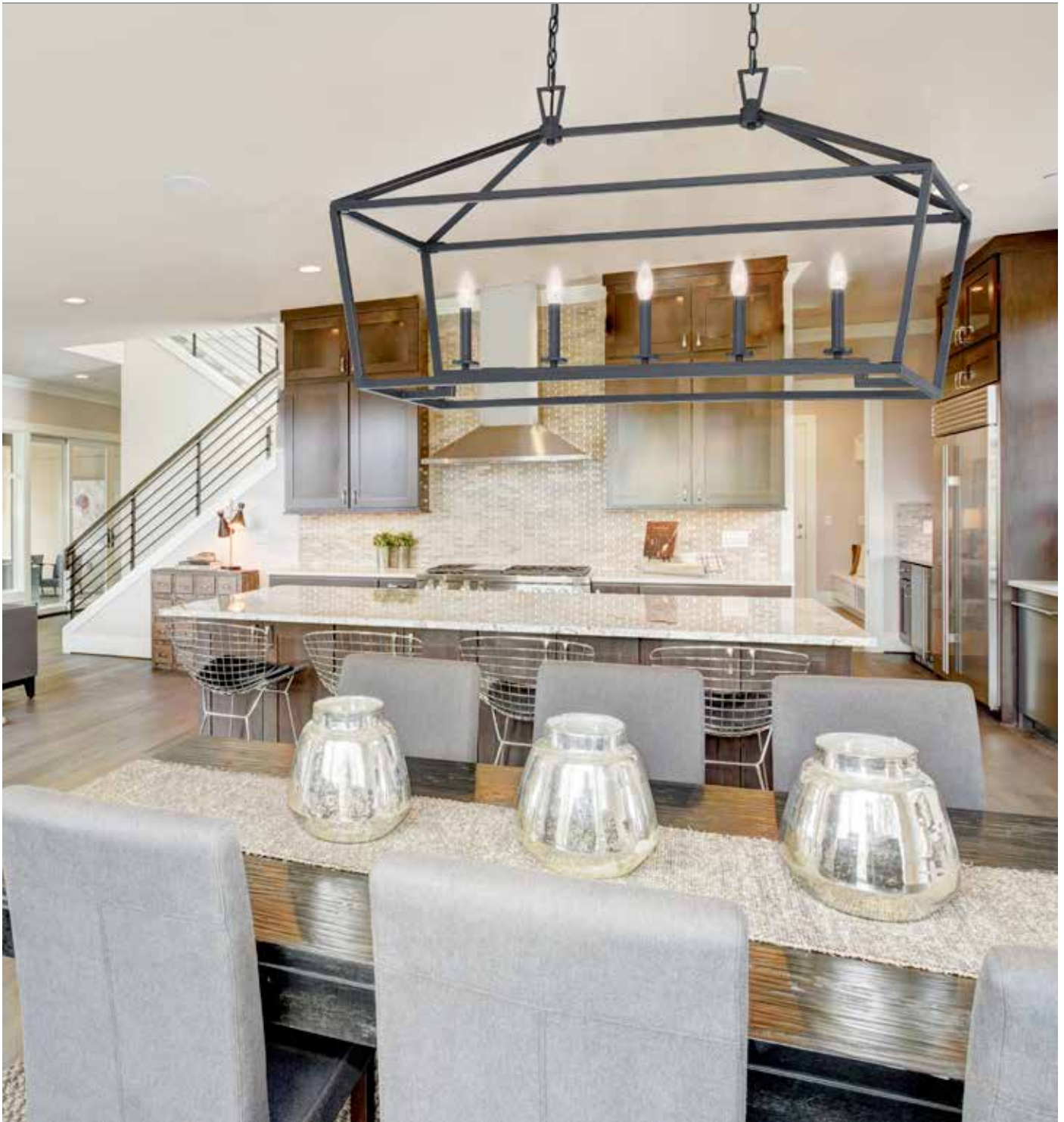

**A. 1-324-5-44**  
5-Light Linear Chandelier  
Classic Bronze Finish  
44"L x 16"W x 23-1/2"H  
5C 60W  
Metal Candle Covers

**B. 1-324-5-SN**  
5-Light Linear Chandelier  
Satin Nickel Finish  
44"L x 16"W x 23-1/2"H  
5C 60W  
Metal Candle Covers

**C. 1-324-5-322**  
5-Light Linear Chandelier  
Warm Brass Finish  
44"L x 16"W x 23-1/2"H  
5C 60W  
Metal Candle Covers

**D. 1-324-5-109**  
5-Light Linear Chandelier  
Polished Nickel Finish  
44"L x 16"W x 23-1/2"H  
5C 60W  
Metal Candle Covers

**E. 1-324-5-89**  
5-Light Linear Chandelier  
Matte Black Finish  
44"L x 16"W x 23-1/2"H  
5C 60W  
Metal Candle Covers

# DENTON

---

A.



B.



C.





**A. 1-326-3-322**  
3-Light Linear Chandelier  
Warm Brass Finish  
32"L x 12"W x 10-1/2"H  
Adj H 10-1/2" - 65-1/2"  
3E 60W  
30° Swivel

**B. 1-326-3-109**  
3-Light Linear Chandelier  
Polished Nickel Finish  
32"L x 12"W x 10-1/2"H  
Adj H 10-1/2" - 65-1/2"  
3E 60W  
30° Swivel

**C. 1-326-3-44**  
3-Light Linear Chandelier  
Classic Bronze Finish  
32"L x 12"W x 10-1/2"H  
Adj H 10-1/2" - 65-1/2"  
3E 60W  
30° Swivel

\*Options: 7-EXT- Extension Rod - 9-1/2"

# DENTON

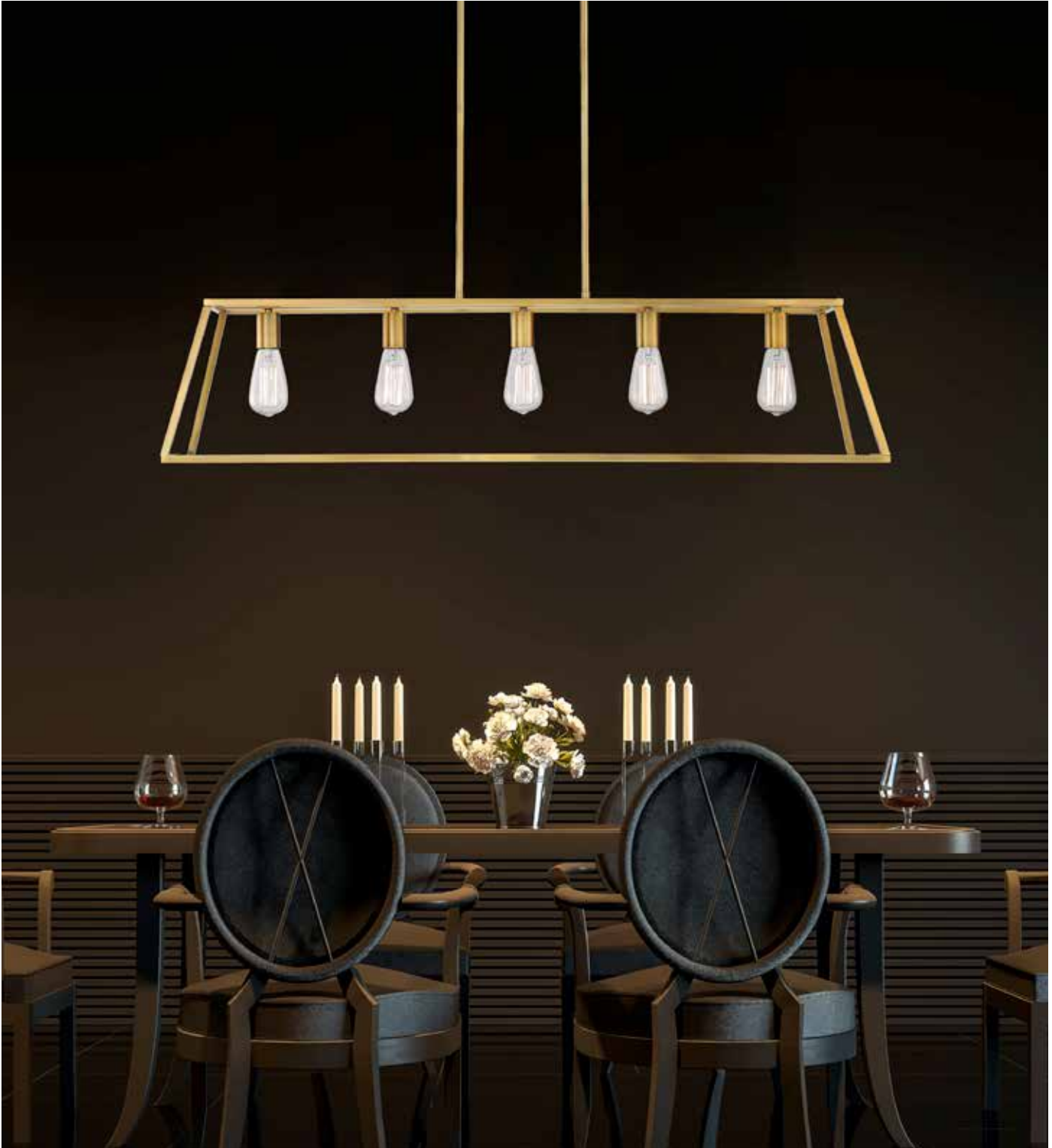

**A. 1-327-5-322**  
5-Light Linear Chandelier  
Warm Brass Finish  
44"L x 12"W x 10-1/2"H  
Adj H 10-1/2" - 65-1/2"  
5E 60W  
30° Swivel

**B. 1-327-5-109**  
5-Light Linear Chandelier  
Polished Nickel Finish  
44"L x 12"W x 10-1/2"H  
Adj H 10-1/2" - 65-1/2"  
5E 60W  
30° Swivel

**C. 1-327-5-44**  
5-Light Linear Chandelier  
Classic Bronze Finish  
44"L x 12"W x 10-1/2"H  
Adj H 10-1/2" - 65-1/2"  
5E 60W  
30° Swivel

# DENTON

A.



B.



C.



\*Options: 7-EXT- Extension Rod - 9-1/2"



# CHATHAM



**A. 1-305-6-89**

6-Light Chandelier  
Matte Black Finish  
28"W x 17-1/2"  
Adj H 17-1/2" - 74"  
6C 60W  
30° Swivel  
White Fabric Shades  
Metal Candle Covers

**B. 1-305-6-SN**

6-Light Chandelier  
Satin Nickel Finish  
28"W x 17-1/2"  
Adj H 17-1/2" - 74"  
6C 60W  
30° Swivel  
White Fabric Shades  
Metal Candle Covers

**C. 1-305-6-322**

6-Light Chandelier  
Warm Brass Finish  
28"W x 17-1/2"  
Adj H 17-1/2" - 74"  
6C 60W  
30° Swivel  
White Fabric Shades  
Metal Candle Covers

**D. 1-305-6-109**

6-Light Chandelier  
Polished Nickel Finish  
28"W x 17-1/2"  
Adj H 17-1/2" - 74"  
6C 60W  
30° Swivel  
White Fabric Shades  
Metal Candle Covers

**E. 1-305-6-44**

6-Light Chandelier  
Classic Bronze Finish  
28"W x 17-1/2"  
Adj H 17-1/2" - 74"  
6C 60W  
30° Swivel  
White Fabric Shades  
Metal Candle Covers



# CHATHAM

A.



B.

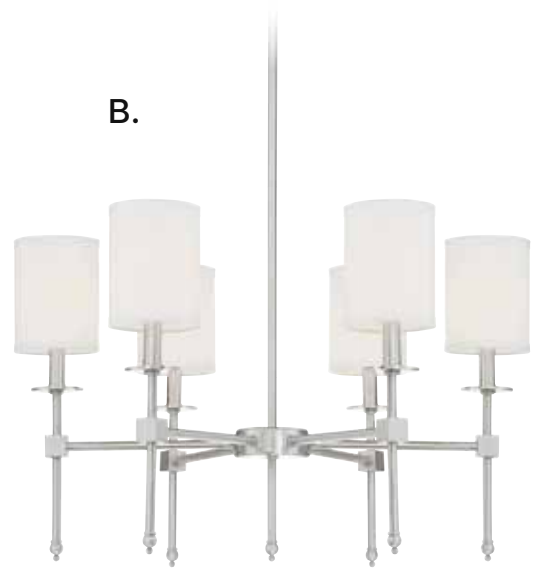

48h\* C.



D.

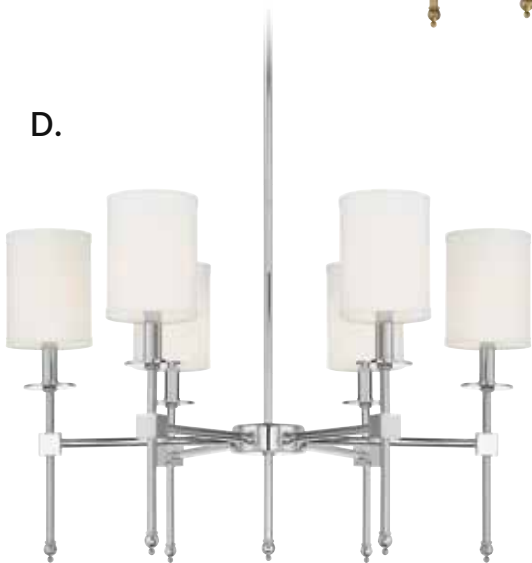

48h\* E.



Options: 7-EXT- Extension Rod - 9-1/2"

**48h\*** except in case of stockout



# CHATHAM

A.

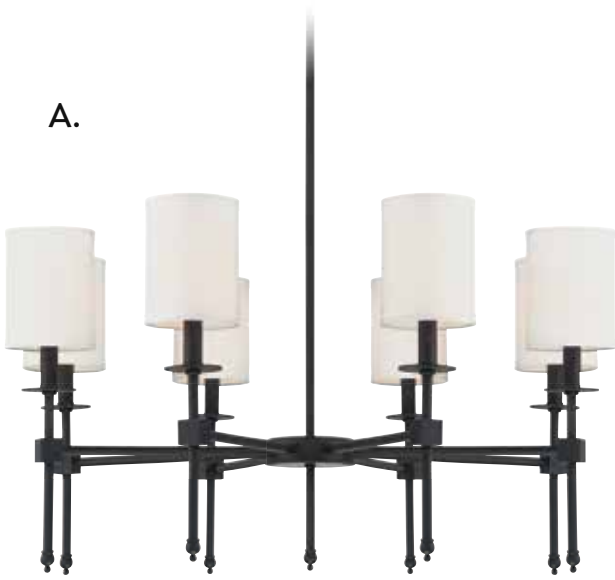

B.

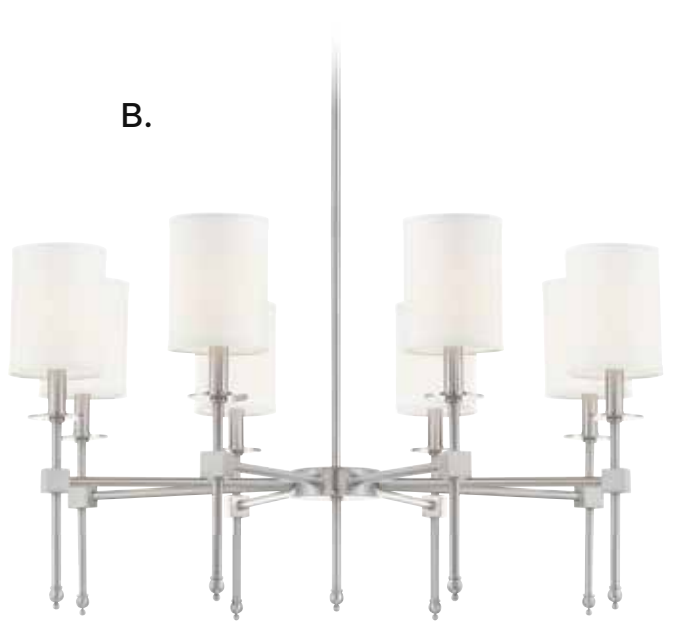

48h\*

C.



D.

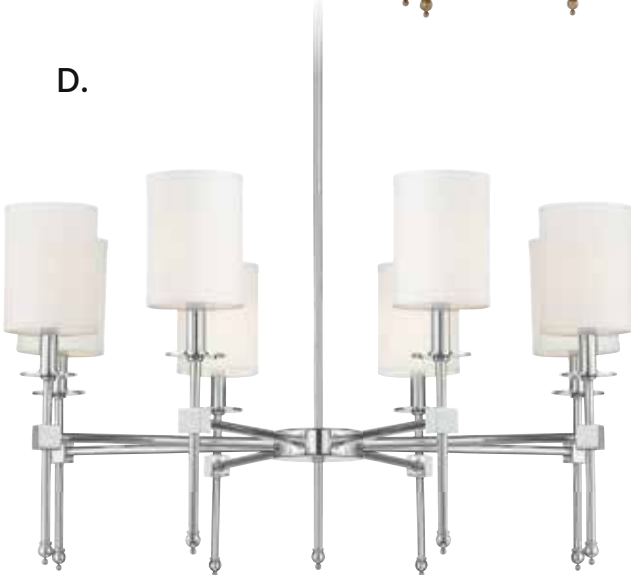

E.

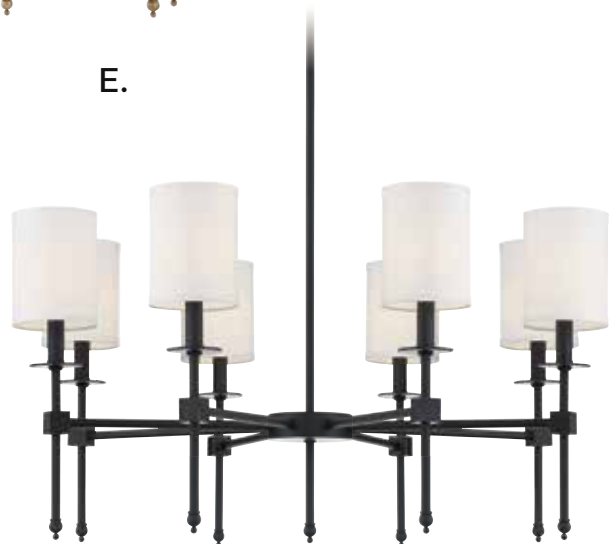

Options: 7-EXT- Extension Rod - 9-1/2"

# CHATHAM



**A. 1-306-8-89**  
8-Light Chandelier  
Matte Black Finish  
32"W x 17-1/2"H  
Adj H 17-1/2" - 74"  
8C 60W  
30° Swivel  
White Fabric Shades  
Metal Candle Covers

**B. 1-306-8-SN**  
8-Light Chandelier  
Satin Nickel Finish  
32"W x 17-1/2"H  
Adj H 17-1/2" - 74"  
8C 60W  
30° Swivel  
White Fabric Shades  
Metal Candle Covers

**C. 1-306-8-322**  
8-Light Chandelier  
Warm Brass Finish  
32"W x 17-1/2"H  
Adj H 17-1/2" - 74"  
8C 60W  
30° Swivel  
White Fabric Shades  
Metal Candle Covers

**D. 1-306-8-109**  
8-Light Chandelier  
Polished Nickel Finish  
32"W x 17-1/2"H  
Adj H 17-1/2" - 74"  
8C 60W  
30° Swivel  
White Fabric Shades  
Metal Candle Covers

**E. 1-306-8-44**  
8-Light Chandelier  
Classic Bronze Finish  
32"W x 17-1/2"H  
Adj H 17-1/2" - 74"  
8C 60W  
30° Swivel  
White Fabric Shades  
Metal Candle Covers

# OCTAVE



**A. 7-4034-3-BK**  
3-Light Pendant  
Matte Black Finish  
15"W x 18"H  
3E 60W  
Clear Glass

**B. 1-4031-3-BK**  
3-Light Chandelier  
Matte Black Finish  
18"W x 16"H  
3E 60W  
Clear Glass

**C. 1-4032-5-BK**  
5-Light Chandelier  
Matte Black Finish  
23"W x 18-1/2"H  
5E 60W  
Clear Glass

**D. 1-4033-9-BK**  
9-Light Chandelier  
Matte Black Finish  
30"W x 28"H  
9E 60W  
Clear Glass

# OCTAVE

A.

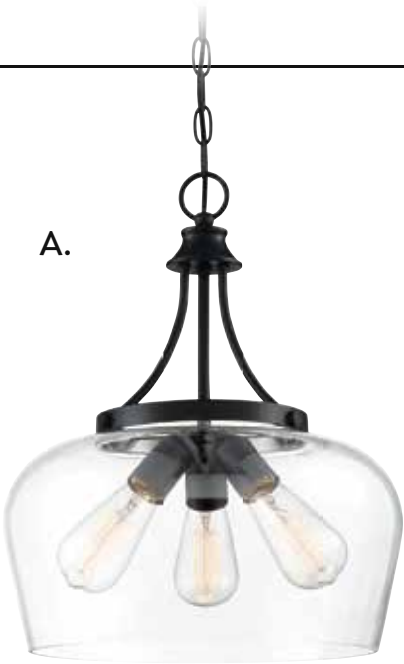

B.



C.



D.



Ceiling, Page 127



Pendant, Page 119



Bath, Page 171



Sconce, Page 171

# OCTAVE



**A. 7-4034-3-322**  
3-Light Pendant  
Warm Brass Finish  
15"W x 18"H  
3E 60W  
Clear Glass

**B. 1-4031-3-322**  
3-Light Chandelier  
Warm Brass Finish  
18"W x 16"H  
3E 60W  
Clear Glass

**C. 1-4032-5-322**  
5-Light Chandelier  
Warm Brass Finish  
23"W x 18-1/2"H  
5E 60W  
Clear Glass

**D. 1-4033-9-322**  
9-Light Chandelier  
Warm Brass Finish  
30"W x 28"H  
9E 60W  
Clear Glass

# OCTAVE

A.

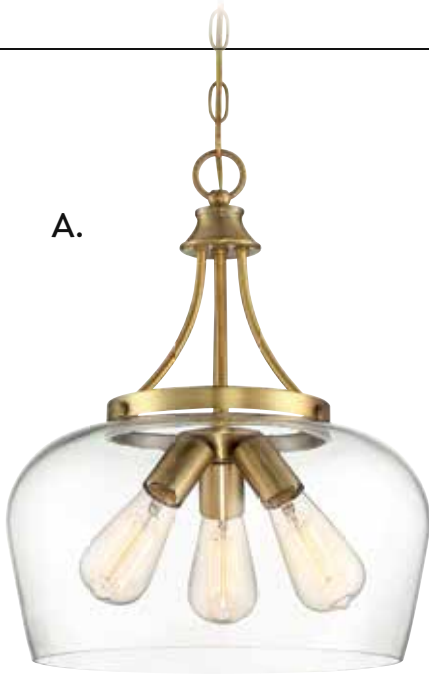

B.

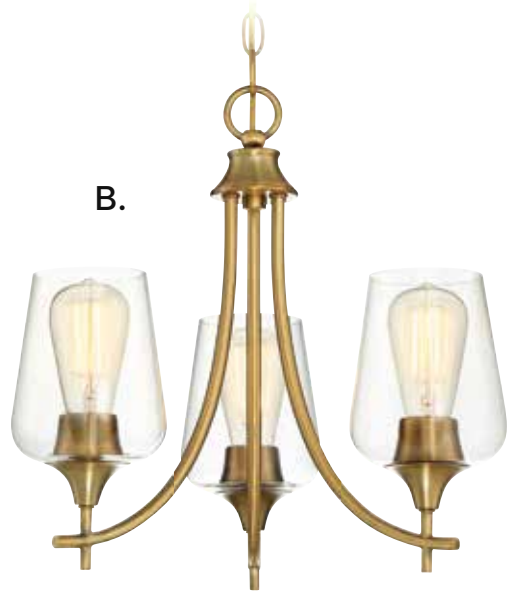

C.

48h\*



D.

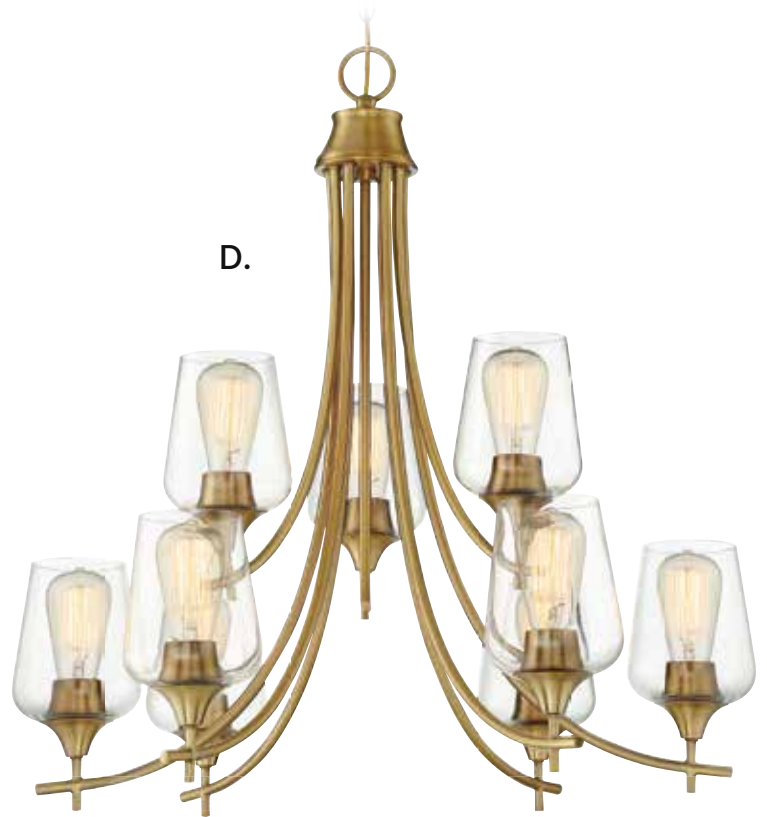

Ceiling, Page 127



Pendant, Page 119



Bath, Page 172



Sconce, Page 172

# OCTAVE



**A. 7-4034-3-11**  
3-Light Pendant  
Polished Chrome Finish  
15"W x 18"H  
3E 60W  
Clear Glass

**B. 1-4031-3-11**  
3-Light Chandelier  
Polished Chrome Finish  
18"W x 16"H  
3E 60W  
Clear Glass

**C. 1-4032-5-11**  
5-Light Chandelier  
Polished Chrome Finish  
23"W x 18-1/2"H  
5E 60W  
Clear Glass

**D. 1-4033-9-11**  
9-Light Chandelier  
Polished Chrome Finish  
30"W x 28"H  
9E 60W  
Clear Glass



# OCTAVE

A.



B.



C.



D.



Ceiling, Page 127



Pendant, Page 119



Bath, Page 171



Sconce, Page 171

# OCTAVE



**A. 7-4034-3-SN**  
3-Light Pendant  
Satin Nickel Finish  
15"W x 18"H  
3E 60W  
Clear Glass

**B. 1-4031-3-SN**  
3-Light Chandelier  
Satin Nickel Finish  
18"W x 16"H  
3E 60W  
Clear Glass

**C. 1-4032-5-SN**  
5-Light Chandelier  
Satin Nickel Finish  
23"W x 18-1/2"H  
5E 60W  
Clear Glass

**D. 1-4033-9-SN**  
9-Light Chandelier  
Satin Nickel Finish  
30"W x 28"H  
9E 60W  
Clear Glass

# OCTAVE

A.



B.

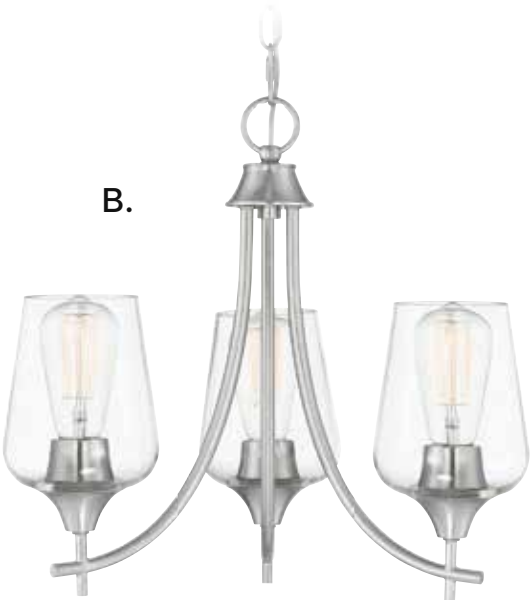

C.



D.

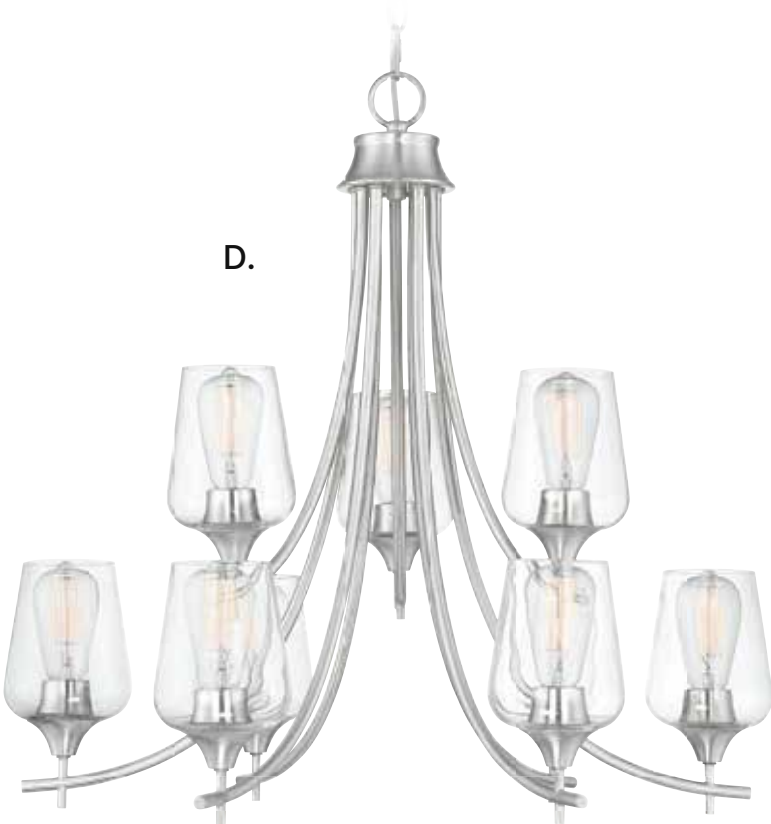

Ceiling, Page 127



Pendant, Page 119



Bath, Page 173



Sconce, Page 173

# OCTAVE

---



**A. 7-4034-3-13**  
3-Light Pendant  
English Bronze Finish  
15"W x 18"H  
3E 60W  
Clear Glass

**B. 1-4031-3-13**  
3-Light Chandelier  
English Bronze Finish  
18"W x 16"H  
3E 60W  
Clear Glass

**C. 1-4032-5-13**  
5-Light Chandelier  
English Bronze Finish  
23"W x 18-1/2"H  
5E 60W  
Clear Glass

**D. 1-4033-9-13**  
9-Light Chandelier  
English Bronze Finish  
30"W x 28"H  
9E 60W  
Clear Glass

# OCTAVE

A.



B.



C.

48h\*



D.



Ceiling, Page 127



Pendant, Page 119



Bath, Page 172



Scence, Page 172

# DUNBAR

---

A.

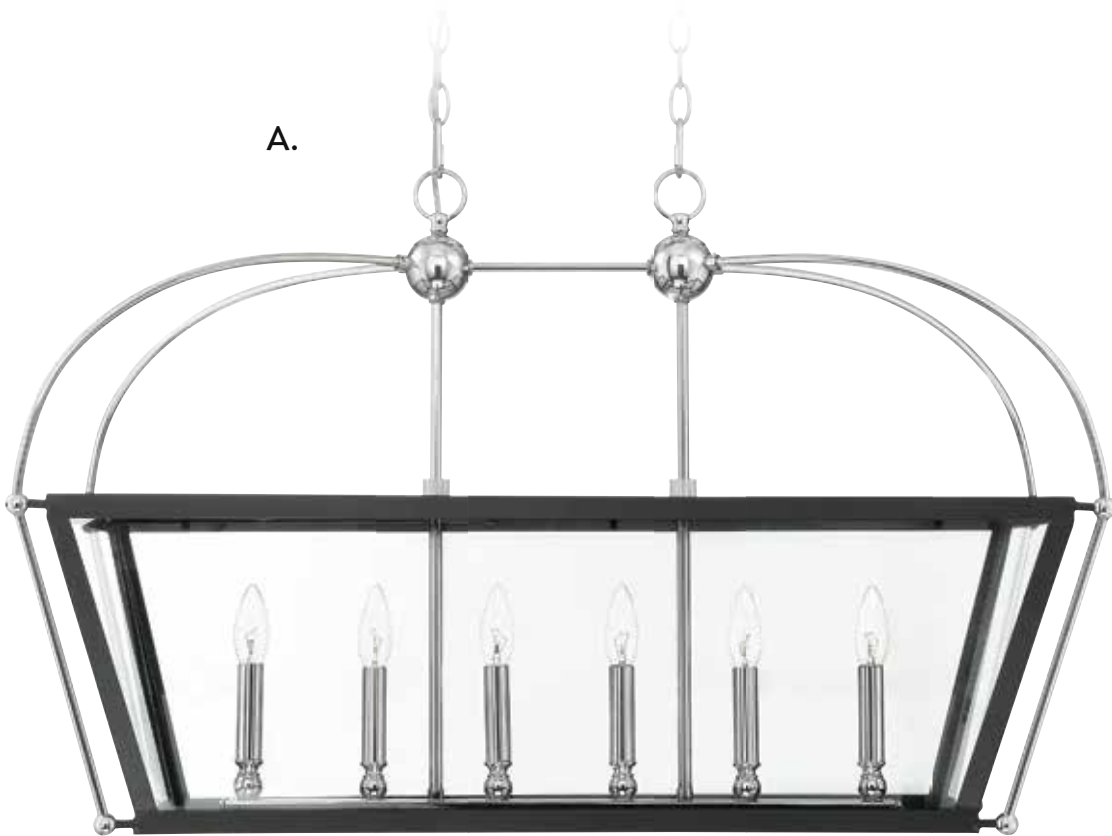

B.



# DUNBAR



**A. 1-9075-6-67**  
6-Light Linear Chandelier  
Matte Black w/ Polished Chrome Accents Finish  
36"L x 16"W x 22"H  
6C 60W  
Clear Glass  
Metal Candle Covers

**B. 1-9075-6-79**  
6-Light Linear Chandelier  
English Bronze & Warm Brass Finish  
36"L x 16"W x 22"H  
6C 60W  
Clear Glass  
Metal Candle Covers

# DUNBAR



**A. 3-9074-4-67**  
4-Light Foyer  
Matte Black w/ Polished  
Chrome Accents Finish  
14"W x 28"H  
4C 60W  
Clear Glass  
Metal Candle Covers

**B. 3-9074-8-67**  
8-Light Foyer  
Matte Black w/ Polished  
Chrome Accents Finish  
20"W x 38"H  
8C 60W  
Clear Glass  
Metal Candle Covers

**C. 3-9074-8-79**  
8-Light Foyer  
English Bronze & Warm  
Brass Finish  
20"W x 38"H  
8C 60W  
Clear Glass  
Metal Candle Covers

**D. 3-9074-4-79**  
4-Light Foyer  
English Bronze & Warm  
Brass Finish  
14"W x 28"H  
4C 60W  
Clear Glass  
Metal Candle Covers



# DUNBAR

A.



B.



C.



D.



# GALEA



**A. 7-6099-24-322**  
24-Light Pendant  
Warm Brass Finish  
23"W x 23"H  
Adj H 23" - 71-1/2"  
24C 25W  
30" Swivel

**B. 7-6099-24-109**  
24-Light Pendant  
Polished Nickel Finish  
23"W x 23"H  
Adj H 23" - 71-1/2"  
24C 25W  
30" Swivel

**C. 7-6099-24-44**  
24-Light Pendant  
Classic Bronze Finish  
23"W x 23"H  
Adj H 23" - 71-1/2"  
24C 25W  
30" Swivel

# GALEA

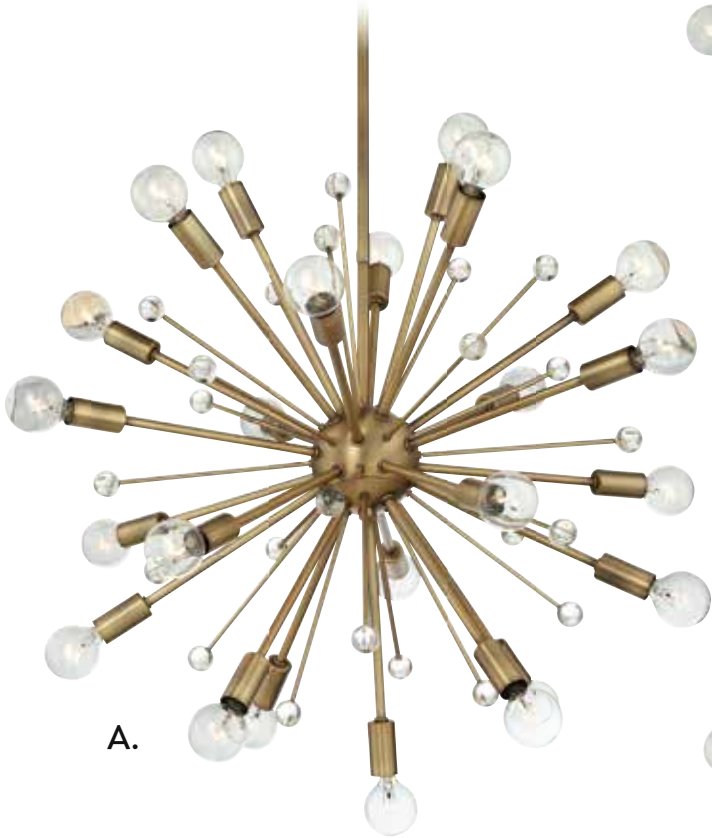

Options: 7-EXT- Extension Rod - 9-1/2"

# MARLY

A.



C.



B.



Options: 7-EXT- Extension Rod - 9-1/2"



**A. 7-6098-12-109**  
 12-Light Pendant  
 Polished Nickel Finish  
 24-1/2"W x 26-1/2"H  
 Adj H 26-1/2" - 80-1/2"  
 12C 60W  
 30° Swivel

**B. 7-6098-12-44**  
 12-Light Pendant  
 Classic Bronze Finish  
 24-1/2"W x 26-1/2"H  
 Adj H 26-1/2" - 80-1/2"  
 12C 60W  
 30° Swivel

**C. 7-6098-12-322**  
 12-Light Pendant  
 Warm Brass Finish  
 24-1/2"W x 26-1/2"H  
 Adj H 26-1/2" - 80-1/2"  
 12C 60W  
 30° Swivel

# DUMONT

A.

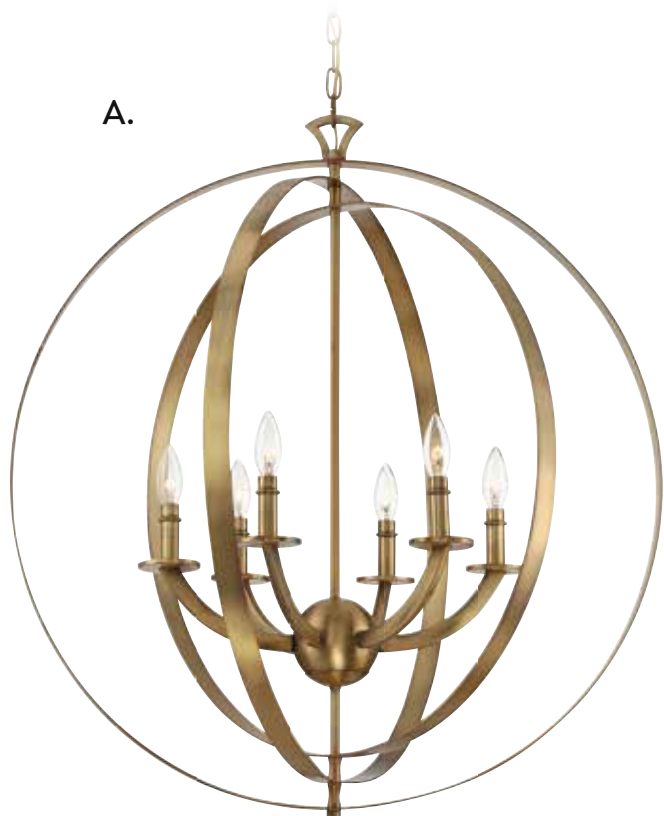

B.

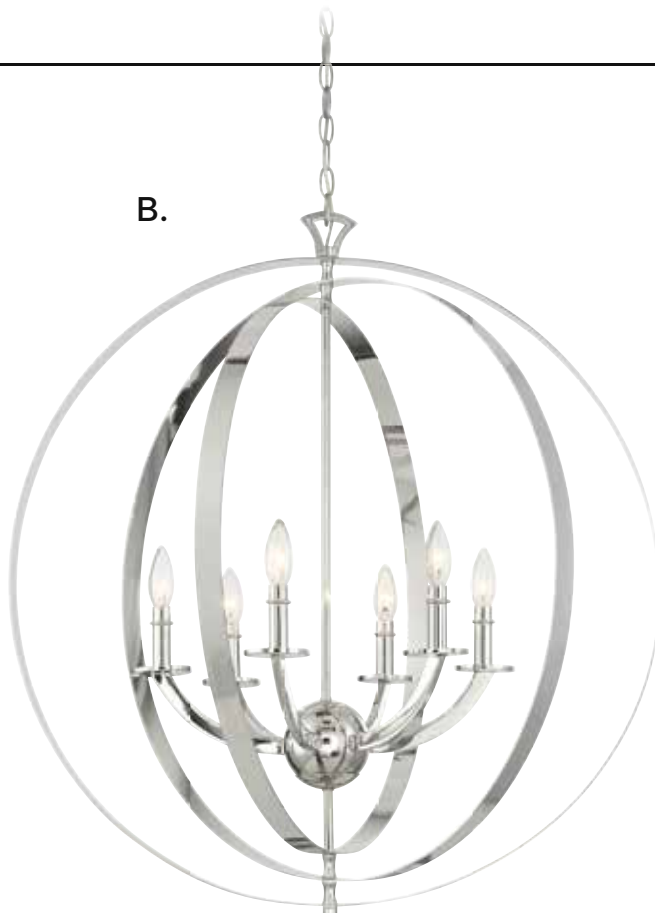

48h\*

C.

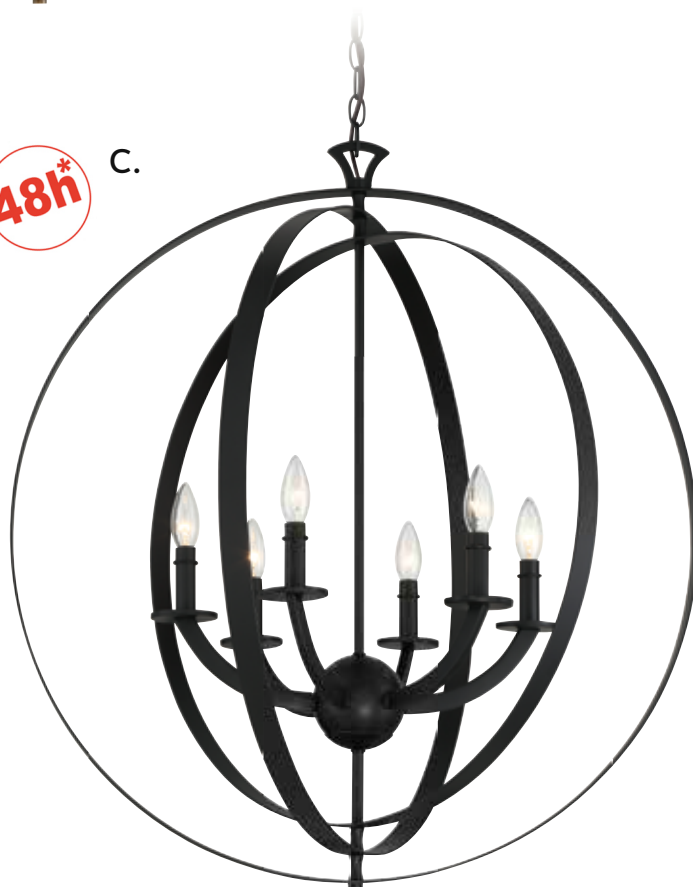

- A. **7-204-6-322**  
6-Light Pendant  
Warm Brass Finish  
32"W x 35-3/4"H  
6C 60W  
Metal Candle Covers
- B. **7-204-6-109**  
6-Light Pendant  
Polished Nickel Finish  
32"W x 35-3/4"H  
6C 60W  
Metal Candle Covers
- C. **7-204-6-44**  
6-Light Pendant  
Classic Bronze Finish  
32"W x 35-3/4"H  
6C 60W  
Metal Candle Covers

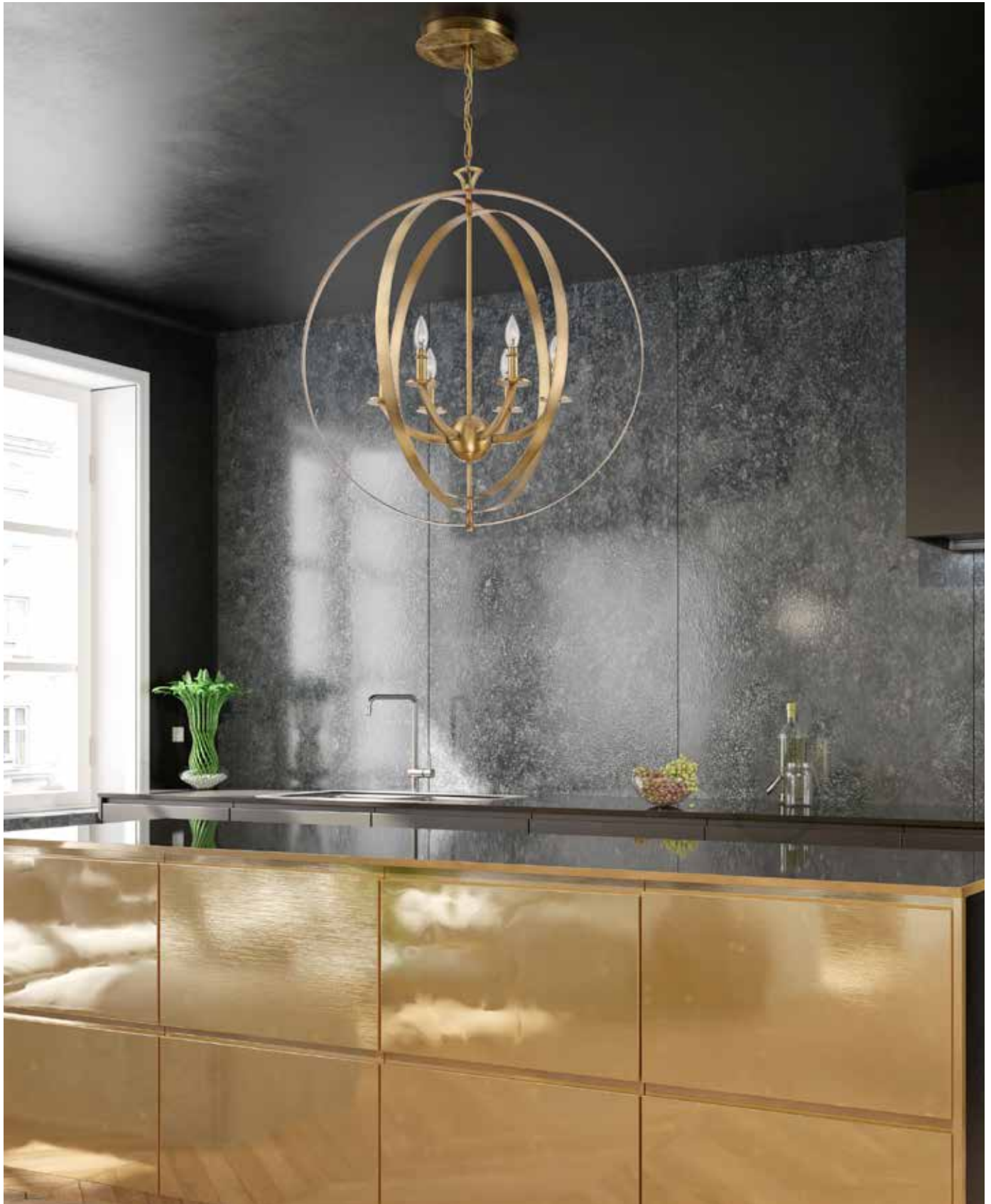

# WILLIAM

48h\*

A.



B.



C.



**A. 7-3103-4-322**

4-Light Pendant  
Warm Brass Finish  
24"W x 30"H  
4E 60W  
Linen Shade  
Frosted Glass

**B. 7-3103-4-109**

4-Light Pendant  
Polished Nickel Finish  
24"W x 30"H  
4E 60W  
Linen Shade  
Frosted Glass

**C. 7-3103-4-44**

4-Light Pendant  
Classic Bronze Finish  
24"W x 30"H  
4E 60W  
Linen Shade  
Frosted Glass





# WILLIAM

---



# WILLIAM



A.



B.

A. **3-3104-4-109**  
4-Light Pendant  
Polished Nickel Finish  
16"W x 33"H  
4C 60W  
Metal Candle Covers

B. **3-3104-4-322**  
4-Light Pendant  
Warm Brass Finish  
16"W x 33"H  
4C 60W  
Metal Candle Covers

C. **3-3104-4-44**  
4-Light Pendant  
Classic Bronze Finish  
16"W x 33"H  
4C 60W  
Metal Candle Covers



C.

# BRAXTON

---

48h\*

A.



C.

48h\*



B.



# BRAXTON

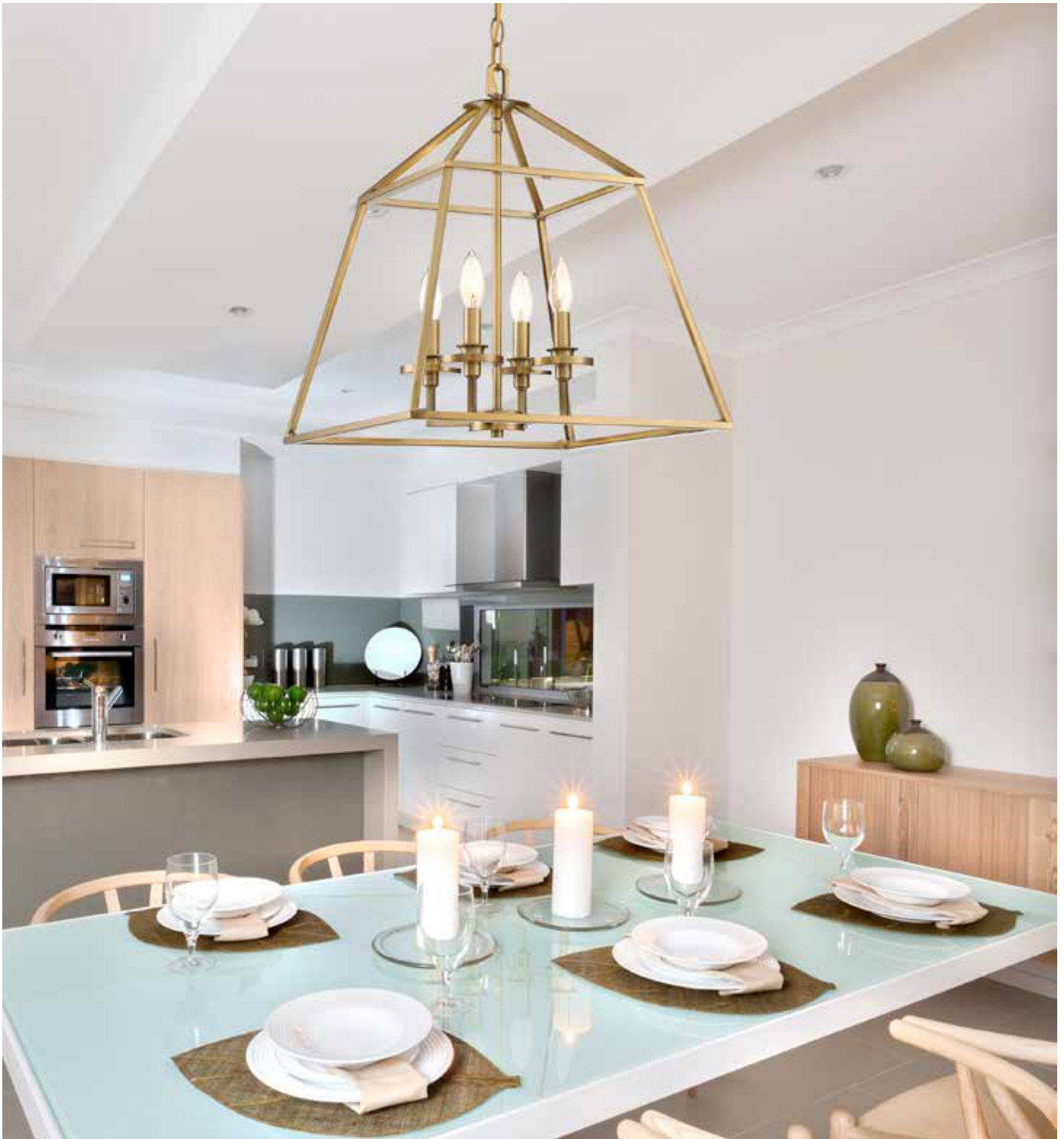

**A. 3-9099-4-322**  
4-Light Pendant  
Warm Brass Finish  
24"W x 19-1/2"H  
4C 60W  
Metal Candle Covers

**B. 3-9099-4-44**  
4-Light Pendant  
Classic Bronze Finish  
24"W x 19-1/2"H  
4C 60W  
Metal Candle Covers

**C. 3-9099-4-109**  
4-Light Pendant  
Polished Nickel Finish  
24"W x 19-1/2"H  
4C 60W  
Metal Candle Covers

# LILLY



**A. 7-203-2-322**  
2-Light Pendant  
Warm Brass Finish  
13"W x 20"H  
2E 60W  
White Opal Glass

**B. 7-203-2-109**  
2-Light Pendant  
Polished Nickel Finish  
13"W x 20"H  
2E 60W  
White Opal Glass

**C. 7-203-2-SN**  
2-Light Pendant  
Satin Nickel Finish  
13"W x 20"H  
2E 60W  
White Opal Glass

**D. 7-203-2-89**  
2-Light Pendant  
Matte Black Finish  
13"W x 20"H  
2E 60W  
White Opal Glass

**E. 7-203-2-44**  
2-Light Pendant  
Classic Bronze Finish  
13"W x 20"H  
2E 60W  
White Opal Glass

48h\*

A.



B.



C.



D.



48h\*

E.



# WESTBOURNE

\*A.



\*B.



**A. 7-3100-1-322**  
1-Light Mini-Pendant  
Warm Brass Finish  
8"W x 11-1/2"H  
Adj H 11-1/2" - 43"  
1E 60W  
90° Swivel  
White Opal Glass

**B. 7-3100-1-SN**  
1-Light Mini-Pendant  
Satin Nickel Finish  
8"W x 11-1/2"H  
Adj H 11-1/2" - 43"  
1E 60W  
90° Swivel  
White Opal Glass

\*Options: 7-EXT- Extension Rod - 9-1/2"



# WESTBOURNE



\*\*C.



\*\*D.



**C. 7-3102-1-322**  
1-Light Pendant  
Warm Brass Finish  
12-3/4"W x 16-1/2"H  
Adj H 16-1/2" - 73-1/2"  
1E 60W  
30° Swivel  
White Opal Glass

**D. 7-3102-1-SN**  
1-Light Pendant  
Satin Nickel Finish  
12-3/4"W x 16-1/2"H  
Adj H 16-1/2" - 73-1/2"  
1E 60W  
30° Swivel  
White Opal Glass

\*\*Options: 7-EXTLG- Extension Rod - 12"



# STIRLING

\*A.



\*B.

48h\*



A. **7-200-3-322**  
 3-Light Pendant  
 Warm Brass Finish  
 12"W x 13"H  
 Adj H 13" - 70"  
 3C 60W  
 30° Swivel  
 Cracked Glass  
 Metal Candle Covers

B. **7-200-3-57**  
 3-Light Pendant  
 Polished Pewter Finish  
 12"W x 13"H  
 Adj H 13" - 70"  
 3C 60W  
 30° Swivel  
 Cracked Glass  
 Metal Candle Covers

\*Options: 7-EXT- Extension Rod - 9-1/2"

# STIRLING



**48h\*** \*\*C.



\*\*D.



**C. 7-201-4-57**  
4-Light Pendant  
Polished Pewter Finish  
19-7/8"W x 21-3/4"H  
Adj H 21-3/4" - 78-3/4"  
4C 60W  
30° Swivel  
Crackled Glass  
Metal Candle Covers

**D. 7-201-4-322**  
4-Light Pendant  
Warm Brass Finish  
19-7/8"W x 21-3/4"H  
Adj H 21-3/4" - 78-3/4"  
4C 60W  
30° Swivel  
Crackled Glass  
Metal Candle Covers

\*\*Options: 7-EXTLG- Extension Rod - 12"

# EPSILON



**A. 7-9161-4-109**  
4-Light Pendant  
Polished Nickel Finish  
20"W x 30"H  
4C 60W  
Optic Acrylic Elements  
Metal Candle Covers

**B. 7-9161-4-322**  
4-Light Pendant  
Warm Brass Finish  
20"W x 30"H  
4C 60W  
Optic Acrylic Elements  
Metal Candle Covers

**C. 7-9160-1-109**  
1-Light Pendant  
Polished Nickel Finish  
12"W x 44-1/2"H  
1E 60W  
90° Swivel  
Optic Acrylic Elements

**D. 7-9160-1-322**  
1-Light Pendant  
Warm Brass Finish  
12"W x 44-1/2"H  
1E 60W  
90° Swivel  
Optic Acrylic Elements

# EPSILON

A.



B.



\*C.



\*D.

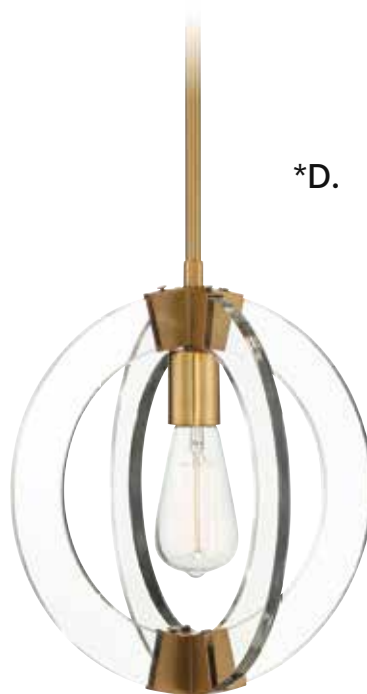

\*Options: 7-EXT- Extension Rod - 9-1/2"

# MAGNUM



- |   |   |  |   |   |  |
|---|---|--|---|---|--|
| <b>A. 7-2137-3-89</b><br>3-Light Pendant<br>Matte Black Finish<br>12-5/8"W x 28"H<br>3C 60W<br>Clear Glass<br>Metal Candle Covers | <b>B. 7-2137-3-11</b><br>3-Light Pendant<br>Polished Chrome Finish<br>12-5/8"W x 28"H<br>3C 60W<br>Clear Glass<br>Metal Candle Covers | <b>C. 7-2137-3-127</b><br>3-Light Pendant<br>Noble Brass Finish<br>12-5/8"W x 28"H<br>3C 60W<br>Clear Glass<br>Metal Candle Covers | <b>D. 7-2138-4-89</b><br>4-Light Pendant<br>Matte Black Finish<br>15-7/8"W x 37"H<br>4C 60W<br>Clear Glass<br>Metal Candle Covers | <b>E. 7-2138-4-11</b><br>4-Light Pendant<br>Polished Chrome Finish<br>15-7/8"W x 37"H<br>4C 60W<br>Clear Glass<br>Metal Candle Covers | <b>F. 7-2138-4-127</b><br>4-Light Pendant<br>Noble Brass Finish<br>15-7/8"W x 37"H<br>4C 60W<br>Clear Glass<br>Metal Candle Covers |
|---|---|--|---|---|--|

# MAGNUM

A.



B.



48h\*

C.



D.



E.



48h\*

F.



# AKRON

---



A.

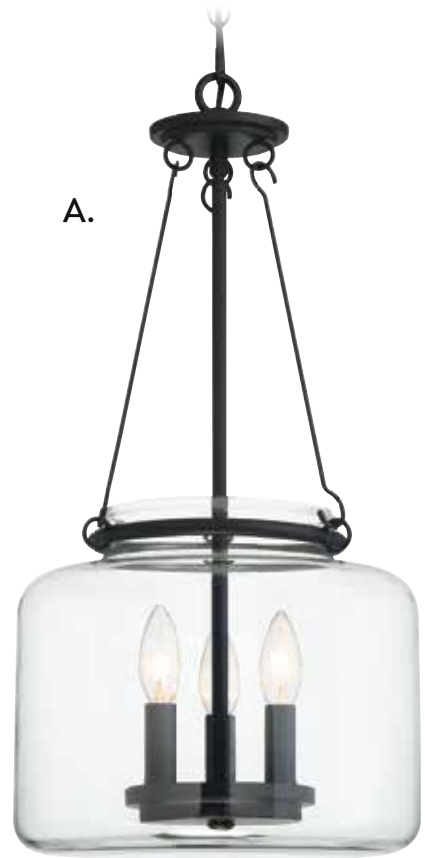



# AKRON

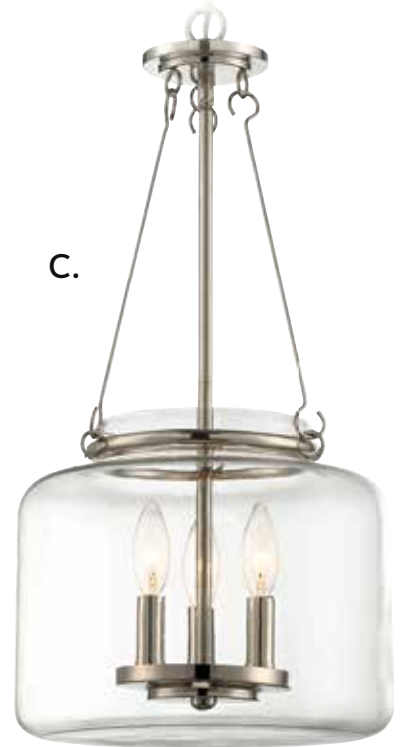

A. 7-9006-3-89  
3-Light Pendant  
Matte Black Finish  
12"W x 24"H  
3C 60W  
Clear Glass  
Metal Candle Covers

B. 7-9006-3-13  
3-Light Pendant  
English Bronze Finish  
12"W x 24"H  
3C 60W  
Clear Glass  
Metal Candle Covers

C. 7-9006-3-109  
3-Light Pendant  
Polished Nickel Finish  
12"W x 24"H  
3C 60W  
Clear Glass  
Metal Candle Covers

D. 7-9006-3-SN  
3-Light Pendant  
Satin Nickel Finish  
12"W x 24"H  
3C 60W  
Clear Glass  
Metal Candle Covers

E. 7-9006-3-322  
3-Light Pendant  
Warm Brass Finish  
12"W x 24"H  
3C 60W  
Clear Glass  
Metal Candle Covers

# DASH



**48h\*** A.



B.



**48h\*** C.



**48h\*** E.



**48h\*** D.

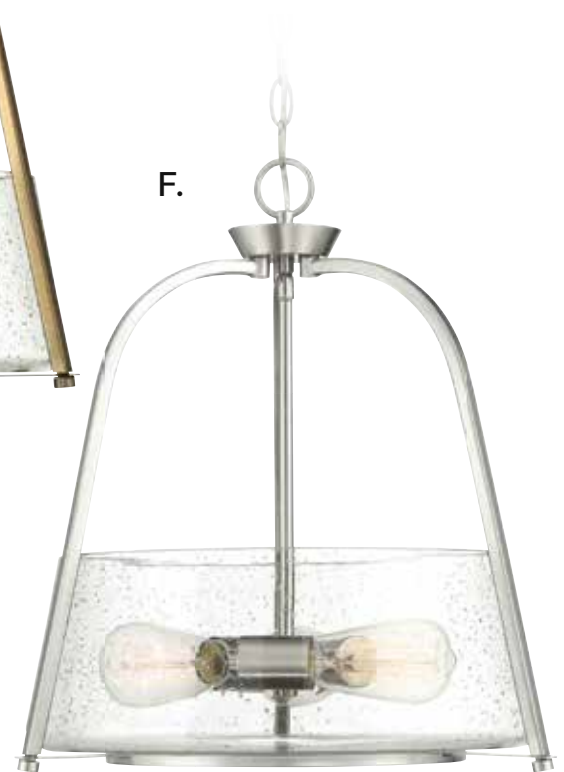

F.

A. 6-2183-3-13  
3-Light Semi-Flush  
English Bronze Finish  
16"W x 13"H  
3E 60W  
Clear Seeded Glass

B. 6-2183-3-322  
3-Light Semi-Flush  
Warm Brass Finish  
16"W x 13"H  
3E 60W  
Clear Seeded Glass

C. 6-2183-3-SN  
3-Light Semi-Flush  
Satin Nickel Finish  
16"W x 13"H  
3E 60W  
Clear Seeded Glass

D. 7-2180-3-13  
3-Light Pendant  
English Bronze Finish  
18"W x 19"H  
3E 60W  
Clear Seeded Glass

E. 7-2180-3-322  
3-Light Pendant  
Warm Brass Finish  
18"W x 19"H  
3E 60W  
Clear Seeded Glass

F. 7-2180-3-SN  
3-Light Pendant  
Satin Nickel Finish  
18"W x 19"H  
3E 60W  
Clear Seeded Glass



G.



H.

48h\*



I.

48h\*

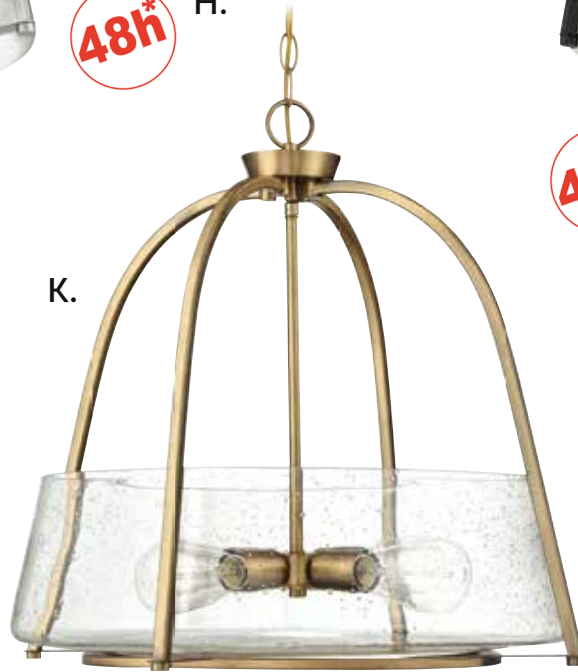

K.

48h\*



J.

48h\*



L.

G. 6-2182-16-SN  
16" Flush Mount  
Satin Nickel Finish  
16"W x 6-3/4"H  
3E 60W  
Clear Seeded Glass

H. 6-2182-16-322  
16" Flush Mount  
Warm Brass Finish  
16"W x 6-3/4"H  
3E 60W  
Clear Seeded Glass

I. 6-2182-16-13  
16" Flush Mount  
English Bronze Finish  
16"W x 6-3/4"H  
3E 60W  
Clear Seeded Glass

J. 7-2181-4-SN  
4-Light Pendant  
Satin Nickel Finish  
22"W x 24-3/4"H  
4E 60W  
Clear Seeded Glass

K. 7-2181-4-322  
4-Light Pendant  
Warm Brass Finish  
22"W x 24-3/4"H  
4E 60W  
Clear Seeded Glass

L. 7-2181-4-13  
4-Light Pendant  
English Bronze Finish  
22"W x 24-3/4"H  
4E 60W  
Clear Seeded Glass

# GARRETT

A.



B.



C.

48h\*

D.



# GARRETT



**A. 3-3057-8-13**

8-Light Foyer  
English Bronze Finish  
18"W x 36-1/2"H  
8C 60W  
Clear Glass  
Metal Candle Covers

**B. 3-3055-4-13**

4-Light Foyer  
English Bronze Finish  
12"W x 23"H  
4C 60W  
Clear Glass  
Metal Candle Covers

**C. 6-3058-4-13**

12" Flush Mount  
English Bronze Finish  
12-3/8"W x 11"H  
4C 60W  
Clear Glass  
Metal Candle Covers

**D. 3-3056-4-13**

4-Light Foyer  
English Bronze Finish  
15"W x 28-1/4"H  
4C 60W  
Clear Glass  
Metal Candle Covers

# GARRETT



**A. 3-3055-4-109**

4-Light Foyer  
Polished Nickel Finish  
12"W x 23"H  
4C 60W  
Clear Glass  
Metal Candle Covers

**B. 3-3057-8-109**

8-Light Foyer  
Polished Nickel Finish  
18"W x 36-1/2"H  
8C 60W  
Clear Glass  
Metal Candle Covers

**C. 3-3056-4-109**

4-Light Foyer  
Polished Nickel Finish  
15"W x 28-1/4"H  
4C 60W  
Clear Glass  
Metal Candle Covers

**D. 6-3058-4-109**

12" Flush Mount  
Polished Nickel Finish  
12-3/8"W x 11"H  
4C 60W  
Clear Glass  
Metal Candle Covers

# GARRETT

A.



B.



C.



D.



# PENROSE



48h\*

A.



B.



C.

48h\*

D.



E.



F.



A. 6-1043-3-13

3-Light Semi-Flush  
English Bronze Finish  
12-1/2"W x 14"H  
3C 60W  
Clear Glass  
Metal Candle Covers

B. 6-1043-3-109

3-Light Semi-Flush  
Polished Nickel Finish  
12-1/2"W x 14"H  
3C 60W  
Clear Glass  
Metal Candle Covers

C. 6-1043-3-BK

3-Light Semi-Flush  
Matte Black Finish  
12-1/2"W x 14"H  
3C 60W  
Clear Glass  
Metal Candle Covers

D. 7-1040-3-13

3-Light Foyer  
English Bronze Finish  
12"W x 26"H  
3C 60W  
Clear Glass  
Metal Candle Covers

E. 7-1040-3-109

3-Light Foyer  
Polished Nickel Finish  
12"W x 26"H  
3C 60W  
Clear Glass  
Metal Candle Covers

F. 7-1040-3-BK

3-Light Foyer  
Matte Black Finish  
12"W x 26"H  
3C 60W  
Clear Glass  
Metal Candle Covers



# PENROSE



**48h\*** G.



**48h\***  
H.



**G. 6-1043-3-SN**  
3-Light Semi-Flush  
Satin Nickel Finish  
12-1/2"W x 14"H  
3C 60W  
Clear Glass  
Metal Candle Covers

**H. 7-1040-3-SN**  
3-Light Foyer  
Satin Nickel Finish  
12"W x 26"H  
3C 60W  
Clear Glass  
Metal Candle Covers

# PENROSE

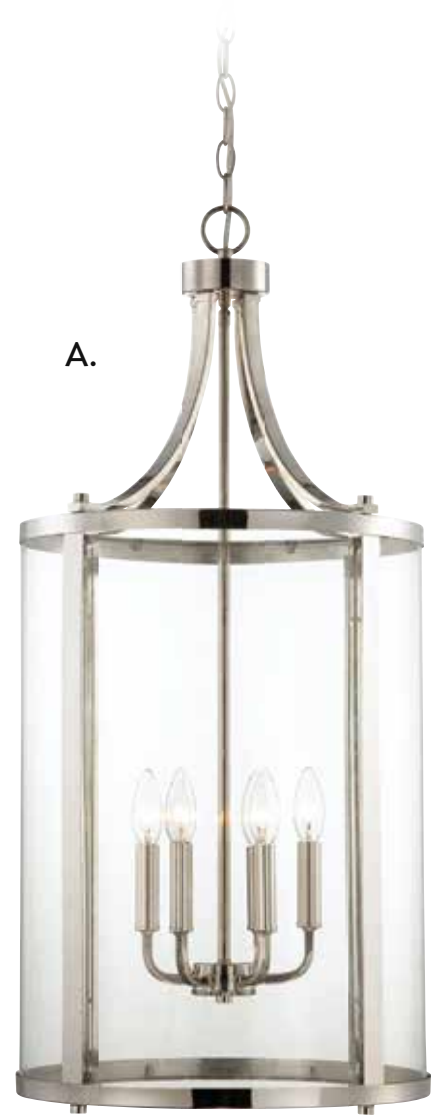

A. 7-1041-6-109  
6-Light Foyer  
Polished Nickel Finish  
16"W x 34"H  
6C 60W  
Clear Glass  
Metal Candle Covers

# PENROSE



B.

**B. 7-1041-6-BK**  
6-Light Foyer  
Matte Black Finish  
16"W x 34"H  
6C 60W  
Clear Glass  
Metal Candle Covers



C.

48h\*

**C. 7-1041-6-SN**  
6-Light Foyer  
Satin Nickel Finish  
16"W x 34"H  
6C 60W  
Clear Glass  
Metal Candle Covers



D.

48h\*

**D. 7-1041-6-13**  
6-Light Foyer  
English Bronze Finish  
16"W x 34"H  
6C 60W  
Clear Glass  
Metal Candle Covers

# PENROSE

---

A.



B.



**A. 7-1042-12-SN**  
12-Light Foyer  
Satin Nickel Finish  
20"W x 42"H  
12C 60W  
Clear Glass  
Metal Candle Covers

**B. 7-1042-12-109**  
12-Light Foyer  
Polished Nickel Finish  
20"W x 42"H  
12C 60W  
Clear Glass  
Metal Candle Covers

**C. 7-1042-12-13**  
12-Light Foyer  
English Bronze Finish  
20"W x 42"H  
12C 60W  
Clear Glass  
Metal Candle Covers

# PENROSE



# ALDEN



- A. 7-131-1-109**  
1-Light Pendant  
Polished Nickel Finish  
18-1/4"W x 12-1/2"H  
Adj H 12-1/2" - 33-3/4"  
1E 60W
- B. 7-132-1-109**  
1-Light Pendant  
Polished Nickel Finish  
12"W x 8-1/2"H  
Adj H 8-1/2" - 30"  
1E 60W
- C. 7-131-1-323**  
1-Light Pendant  
Old Bronze Finish  
18-1/4"W x 12-1/2"H  
Adj H 12-1/2" - 33-3/4"  
1E 60W
- D. 7-132-1-323**  
1-Light Pendant  
Old Bronze Finish  
12"W x 8-1/2"H  
Adj H 8-1/2" - 30"  
1E 60W
- E. 7-131-1-322**  
1-Light Pendant  
Warm Brass Finish  
18-1/4"W x 12-1/2"H  
Adj H 12-1/2" - 33-3/4"  
1E 60W
- F. 7-132-1-322**  
1-Light Pendant  
Warm Brass Finish  
12"W x 8-1/2"H  
Adj H 8-1/2" - 30"  
1E 60W
- G. 7-131-1-89**  
1-Light Pendant  
Matte Black Finish  
18-1/4"W x 12-1/2"H  
Adj H 12-1/2" - 33-3/4"  
1E 60W
- H. 7-132-1-89**  
1-Light Pendant  
Matte Black Finish  
12"W x 8-1/2"H  
Adj H 8-1/2" - 30"  
1E 60W

# ALDEN



Pendants come with two sections of decorative linked stems, plus chain.

48h\* except in case of stockout



# AUSTIN

---

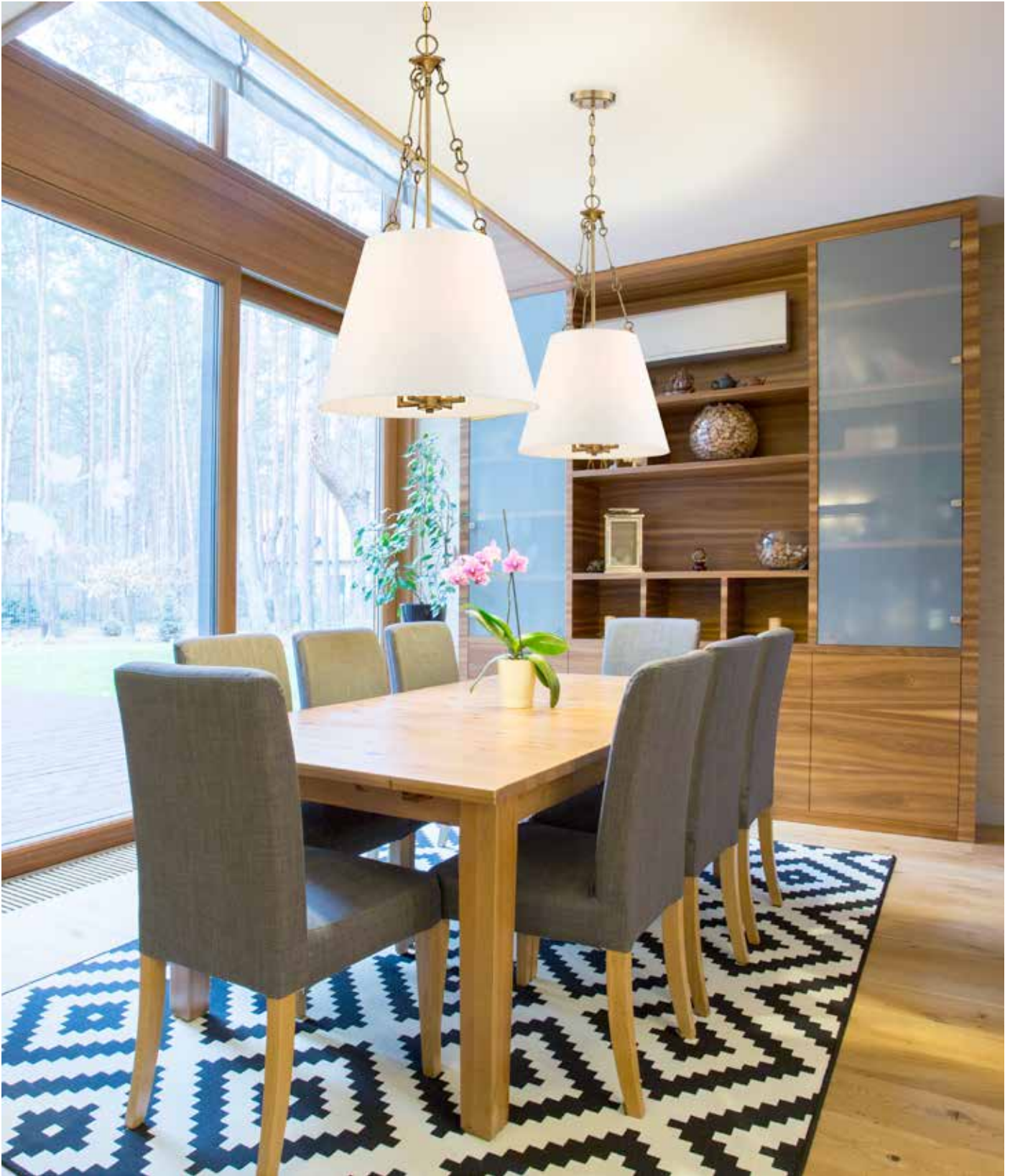



# AUSTIN



A.

A. 7-2201-4-13  
4-Light Pendant  
English Bronze Finish  
18"W x 32-1/2"H  
4C 60W  
White Fabric Shade



B.

B. 7-2201-4-SN  
4-Light Pendant  
Satin Nickel Finish  
18"W x 32-1/2"H  
4C 60W  
White Fabric Shade



C.

C. 7-2201-4-322  
4-Light Pendant  
Warm Brass Finish  
18"W x 32-1/2"H  
4C 60W  
White Fabric Shade

# ASHMONT

---



Options: 7-EXT- Extension Rod - 9-1/2"

# ASHMONT



**A. 7-130-1-109**  
1-Light Pendant  
Polished Nickel Finish  
13"W x 21-1/4"H  
Adj H 21-1/4" - 49-3/4"  
1E 60W  
90° Swivel  
White Opal Glass

**B. 7-130-1-44**  
1-Light Pendant  
Classic Bronze Finish  
13"W x 21-1/4"H  
Adj H 21-1/4" - 49-3/4"  
1E 60W  
90° Swivel  
White Opal Glass

**C. 7-130-1-63**  
1-Light Pendant  
Warm Brass Lustre Finish  
13"W x 21-1/4"H  
Adj H 21-1/4" - 49-3/4"  
1E 60W  
90° Swivel  
White Opal Glass

**D. 7-130-1-SN**  
1-Light Pendant  
Satin Nickel Finish  
13"W x 21-1/4"H  
Adj H 21-1/4" - 49-3/4"  
1E 60W  
90° Swivel  
White Opal Glass

# SHANE

---

A.



B.



C.



D.





**A. 1-2070-1-109**  
1-Light Pendant  
Polished Nickel Finish  
16"W x 12"H  
1E 60W  
Clear Glass

**B. 1-2070-1-13**  
1-Light Pendant  
English Bronze Finish  
16"W x 12"H  
1E 60W  
Clear Glass

**C. 1-2070-1-322**  
1-Light Pendant  
Warm Brass Finish  
16"W x 12"H  
1E 60W  
Clear Glass

**D. 1-2070-1-SN**  
1-Light Pendant  
Satin Nickel Finish  
16"W x 12"H  
1E 60W  
Clear Glass

# GARVEY

\*A.



**48h\*** \*B.



**48h\*** \*C.



**A. 7-5012-1-322**  
 1-Light Pendant  
 Warm Brass Finish  
 14"W x 16-1/2"H  
 Adj H 16-1/2" - 48"  
 1E 60W  
 90° Swivel  
 Clear Glass

**B. 7-5012-1-13**  
 1-Light Pendant  
 English Bronze Finish  
 14"W x 16-1/2"H  
 Adj H 16-1/2" - 48"  
 1E 60W  
 90° Swivel  
 Clear Glass

**C. 7-5012-1-109**  
 1-Light Pendant  
 Polished Nickel Finish  
 14"W x 16-1/2"H  
 Adj H 16-1/2" - 48"  
 1E 60W  
 90° Swivel  
 Clear Glass

\*Options: 7-EXT- Extension Rod - 9-1/2"

# MAYFIELD

D. 7-17000-1-109  
 1-Light Pendant  
 Polished Nickel Finish  
 15-1/2"W x 13"H  
 1E 60W  
 Clear Glass

E. 7-17000-1-13  
 1-Light Pendant  
 English Bronze Finish  
 15-1/2"W x 13"H  
 1E 60W  
 Clear Glass

F. 7-17000-1-322  
 1-Light Pendant  
 Warm Brass Finish  
 15-1/2"W x 13"H  
 1E 60W  
 Clear Glass

D.



E.

**48h\***



F.

**48h\***



# DRAKE



48h\*

B.



48h\*

C.



D.



A. 7-9132-1-109  
1-Light Pendant  
Polished Nickel Finish  
10"W x 11-1/2"H  
Adj H 11-1/2" - 43"  
1E 60W  
90° Swivel  
Clear Glass

B. 7-9132-1-13  
1-Light Pendant  
English Bronze Finish  
10"W x 11-1/2"H  
Adj H 11-1/2" - 43"  
1E 60W  
90° Swivel  
Clear Glass

C. 7-9132-1-322  
1-Light Pendant  
Warm Brass Finish  
10"W x 11-1/2"H  
Adj H 11-1/2" - 43"  
1E 60W  
90° Swivel  
Clear Glass

D. 7-9132-1-SN  
1-Light Pendant  
Satin Nickel Finish  
10"W x 11-1/2"H  
Adj H 11-1/2" - 43"  
1E 60W  
90° Swivel  
Clear Glass

Options: 7-EXT- Extension Rod - 9-1/2"



# OCTAVE



E.



F.



G.



H.



I.



**E. 7-4036-1-SN**  
1-Light Mini-Pendant  
Satin Nickel Finish  
8-1/2"W x 10-1/2"H  
Adj H 10-1/2" - 42"  
1E 60W  
90° Swivel  
Clear Glass

**F. 7-4036-1-BK**  
1-Light Mini-Pendant  
Black Finish  
8-1/2"W x 10-1/2"H  
Adj H 10-1/2" - 42"  
1E 60W  
90° Swivel  
Clear Glass

**G. 7-4036-1-11**  
1-Light Mini-Pendant  
Polished Chrome Finish  
8-1/2"W x 10-1/2"H  
Adj H 10-1/2" - 42"  
1E 60W  
90° Swivel  
Clear Glass

**H. 7-4036-1-322**  
1-Light Mini-Pendant  
Warm Brass Finish  
8-1/2"W x 10-1/2"H  
Adj H 10-1/2" - 42"  
1E 60W  
90° Swivel  
Clear Glass

**I. 7-4036-1-13**  
1-Light Mini-Pendant  
English Bronze Finish  
8-1/2"W x 10-1/2"H  
Adj H 10-1/2" - 42"  
1E 60W  
90° Swivel  
Clear Glass

# FRANKLIN



**A. 7-702-1-13**  
1-Light Pendant  
English Bronze Finish  
10"W x 20"H  
1E 60W  
Clear Glass

**B. 7-703-1-SN**  
1-Light Pendant  
Satin Nickel Finish  
10"W x 20"H  
1E 60W  
Silver Mercury Glass

**C. 7-702-1-109**  
1-Light Pendant  
Polished Nickel Finish  
10"W x 20"H  
1E 60W  
Clear Glass

**D. 7-700-1-109**  
1-Light Mini-Pendant  
Polished Nickel Finish  
6-1/2"W x 12"H  
1E 60W  
Clear Glass

**E. 7-701-1-SN**  
1-Light Mini-Pendant  
Satin Nickel Finish  
6-1/2"W x 12"H  
1E 60W  
Silver Mercury Glass

**F. 7-700-1-13**  
1-Light Mini-Pendant  
English Bronze Finish  
6-1/2"W x 12"H  
1E 60W  
Clear Glass



**D.**



**E.**



**F.**



# AVALON

---

A.



B.



C.



D.

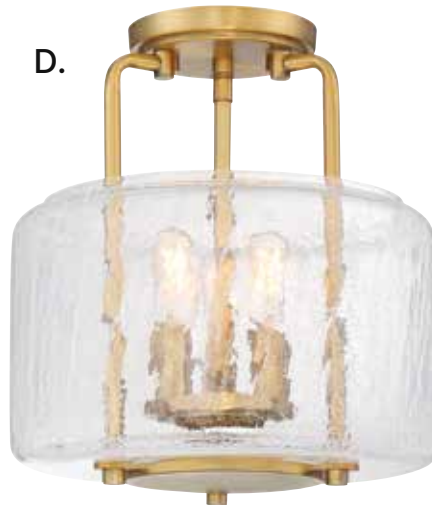

E.



# AVALON



**A. 6-7790-3-SN**  
3-Light Semi-Flush  
Satin Nickel Finish  
11-3/8"W x 12-1/4"H  
3C 60W  
Crackled Glass  
Metal Candle Covers

**B. 6-7790-3-89**  
3-Light Semi-Flush  
Matte Black Finish  
11-3/8"W x 12-1/4"H  
3C 60W  
Crackled Glass  
Metal Candle Covers

**C. 6-7790-3-13**  
3-Light Semi-Flush  
English Bronze Finish  
11-3/8"W x 12-1/4"H  
3C 60W  
Crackled Glass  
Metal Candle Covers

**D. 6-7790-3-322**  
3-Light Semi-Flush  
Warm Brass Finish  
11-3/8"W x 12-1/4"H  
3C 60W  
Crackled Glass  
Metal Candle Covers

**E. 6-7790-3-109**  
3-Light Semi-Flush  
Polished Nickel Finish  
11-3/8"W x 12-1/4"H  
3C 60W  
Crackled Glass  
Metal Candle Covers

# WALPOLE

---

**48h\*** A.



B.



C.



**48h\*** D.



**48h\*** E.



# WALPOLE



**A. 6-9137-1-322**  
1-Light Semi-Flush  
Warm Brass Finish  
11"W x 11-1/2"H  
1E 60W  
Clear Glass

**B. 6-9137-1-109**  
1-Light Semi-Flush  
Polished Nickel Finish  
11"W x 11-1/2"H  
1E 60W  
Clear Glass

**C. 6-9137-1-89**  
1-Light Semi-Flush  
Matte Black Finish  
11"W x 11-1/2"H  
1E 60W  
Clear Glass

**D. 6-9137-1-13**  
1-Light Semi-Flush  
English Bronze Finish  
11"W x 11-1/2"H  
1E 60W  
Clear Glass

**E. 6-9137-1-SN**  
1-Light Semi-Flush  
Satin Nickel Finish  
11"W x 11-1/2"H  
1E 60W  
Clear Glass

# OCTAVE



- A. **6-4037-1-SN**  
1-Light Semi-Flush  
Satin Nickel Finish  
8"W x 14"H  
1E 60W  
Clear Glass
- B. **6-4037-1-BK**  
1-Light Semi-Flush  
Matte Black Finish  
8"W x 14"H  
1E 60W  
Clear Glass
- C. **6-4037-1-11**  
1-Light Semi-Flush  
Polished Chrome Finish  
8"W x 14"H  
1E 60W  
Clear Glass
- D. **6-4037-1-322**  
1-Light Semi-Flush  
Warm Brass Finish  
8"W x 14"H  
1E 60W  
Clear Glass
- E. **6-4037-1-13**  
1-Light Semi-Flush  
English Bronze Finish  
8"W x 14"H  
1E 60W  
Clear Glass





# OCTAVE

- F. **6-4035-3-SN**  
3-Light Semi-Flush  
Satin Nickel Finish  
13"W x 11"H  
3E 60W  
Clear Glass
- G. **6-4035-3-BK**  
3-Light Semi-Flush  
Matte Black Finish  
13"W x 11"H  
3E 60W  
Clear Glass
- H. **6-4035-3-11**  
3-Light Semi-Flush  
Polished Chrome Finish  
13"W x 11"H  
3E 60W  
Clear Glass
- I. **6-4035-3-13**  
3-Light Semi-Flush  
English Bronze Finish  
13"W x 11"H  
3E 60W  
Clear Glass
- J. **6-4035-3-322**  
3-Light Semi-Flush  
Warm Brass Finish  
13"W x 11"H  
3E 60W  
Clear Glass



# DRUMMOND



A.



B.



C.

A. DRUMMOND  
6-2158-16-SN  
16" Flush Mount  
Satin Nickel Finish  
16"W x 6"H  
4C 60W  
Thick Clear Glass

B. DRUMMOND  
6-2158-16-127  
16" Flush Mount  
Noble Brass Finish  
16"W x 6"H  
4C 60W  
Thick Clear Glass

C. DRUMMOND  
6-2158-16-13  
16" Flush Mount  
English Bronze Finish  
16"W x 6"H  
4C 60W  
Thick Clear Glass

D. LACEY  
6-2706-3-322  
16" Flush Mount  
Warm Brass Finish  
16"W x 8-1/2"H  
3E 60W  
White Fabric Shade

E. LACEY  
6-2706-3-109  
16" Flush Mount  
Polished Nickel Finish  
16"W x 8-1/2"H  
3E 60W  
White Fabric Shade

F. LACEY  
6-2706-3-44  
16" Flush Mount  
Classic Bronze Finish  
16"W x 8-1/2"H  
3E 60W  
White Fabric Shade

# LACEY



D.



E.



F.



# SHERRILL

---

**LED**



A.



B.



C.



D.

# SHERRILL

LED

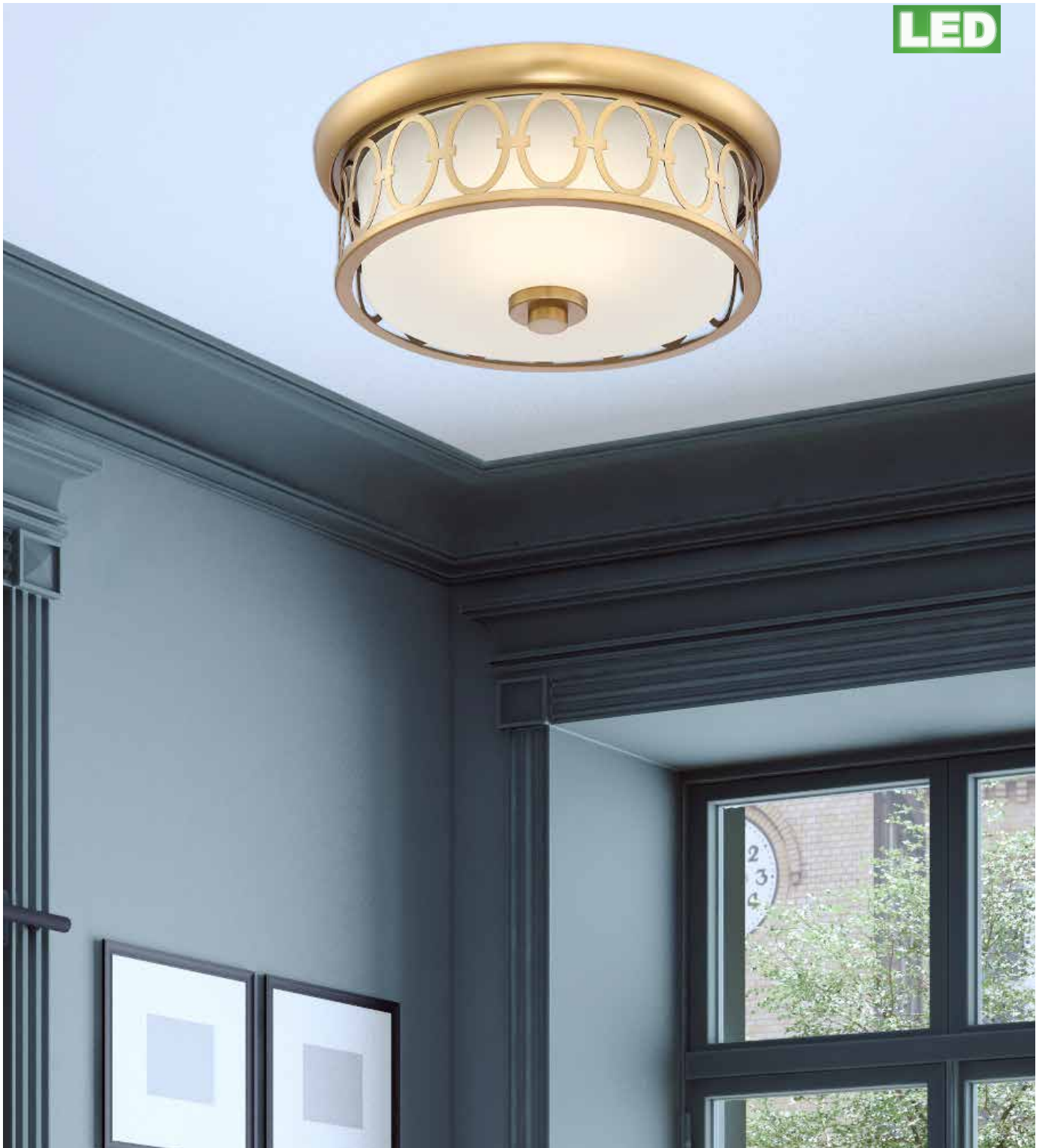

**A. 6-2390-14-SN**  
LED Flush Mount  
Satin Nickel Finish  
14"W x 5-1/2"H  
20W LED Dimmable — 1050  
Lumens, 3000K, 90 CRI  
Etched Glass

**B. 6-2390-14-322**  
LED Flush Mount  
Warm Brass Finish  
14"W x 5-1/2"H  
20W LED Dimmable — 1050  
Lumens, 3000K, 90 CRI  
Etched Glass

**C. 6-2390-14-89**  
LED Flush Mount  
Matte Black Finish  
14"W x 5-1/2"H  
20W LED Dimmable — 1050  
Lumens, 3000K, 90 CRI  
Etched Glass

**D. 6-2390-14-109**  
LED Flush Mount  
Polished Nickel Finish  
14"W x 5-1/2"H  
20W LED Dimmable — 1050  
Lumens, 3000K, 90 CRI  
Etched Glass



# WATKINS



- |                       |                       |                        |                        |                       |                        |
|-----------------------|-----------------------|------------------------|------------------------|-----------------------|------------------------|
| <b>A. 6-134-3-322</b> | <b>B. 6-134-3-44</b>  | <b>C. 6-134-3-109</b>  | <b>D. 6-133-16-322</b> | <b>E. 6-133-16-44</b> | <b>F. 6-133-16-109</b> |
| 3-Light Semi-Flush    | 3-Light Semi-Flush    | 3-Light Semi-Flush     | 16" Flush Mount        | 16" Flush Mount       | 16" Flush Mount        |
| Warm Brass Finish     | Classic Bronze Finish | Polished Nickel Finish | Warm Brass Finish      | Classic Bronze Finish | Polished Nickel Finish |
| 16"W x 9"H            | 16"W x 9"H            | 16"W x 9"H             | 16"W x 4"H             | 16"W x 4"H            | 16"W x 4"H             |
| 3E 60W                | 3E 60W                | 3E 60W                 | 3E 60W                 | 3E 60W                | 3E 60W                 |
| White Opal Glass      | White Opal Glass      | White Opal Glass       | White Opal Glass       | White Opal Glass      | White Opal Glass       |

48h\*

A.



48h\*

B.



C.



48h\*

D.



48h\*

E.



F.



# BENTON

---



  
**BRIAN THOMAS**  
COLLECTION





# BENTON



A.



B.



C.



D.

A. **6-9069-13-SN**  
13" Flush Mount  
Satin Nickel Finish  
13"W x 5-1/8"H  
2E 60W  
Clear Halophane Glass

B. **6-9069-13-13**  
13" Flush Mount  
English Bronze Finish  
13"W x 5-1/8"H  
2E 60W  
Clear Halophane Glass

C. **6-9069-13-322**  
13" Flush Mount  
Warm Brass Finish  
13"W x 5-1/8"H  
2E 60W  
Clear Halophane Glass

D. **6-9069-13-109**  
13" Flush Mount  
Polished Nickel Finish  
13"W x 5-1/8"H  
2E 60W  
Clear Halophane Glass

# LUCERNE



- |   |   |  |  |   |   |
|---|---|--|--|---|---|
| <p><b>A. 6-3351-3-13</b><br/>           3-Light Semi-Flush<br/>           English Bronze Finish<br/>           18-1/2"W x 13-1/2"H<br/>           3E 60W<br/>           White Glass</p> | <p><b>B. 6-3352-2-13</b><br/>           2-Light Semi-Flush<br/>           English Bronze Finish<br/>           16-1/2"W x 10-3/4"H<br/>           2E 60W<br/>           White Glass</p> | <p><b>C. 6-3351-3-322</b><br/>           3-Light Semi-Flush<br/>           Warm Brass Finish<br/>           18-1/2"W x 13-1/2"H<br/>           3E 60W<br/>           White Glass</p> | <p><b>D. 6-3352-2-322</b><br/>           2-Light Semi-Flush<br/>           Warm Brass Finish<br/>           16-1/2"W x 10-3/4"H<br/>           2E 60W<br/>           White Glass</p> | <p><b>E. 6-3351-3-SN</b><br/>           3-Light Semi-Flush<br/>           Satin Nickel Finish<br/>           18-1/2"W x 13-1/2"H<br/>           3E 60W<br/>           White Glass</p> | <p><b>F. 6-3352-2-SN</b><br/>           2-Light Semi-Flush<br/>           Satin Nickel Finish<br/>           16-1/2"W x 10-3/4"H<br/>           2E 60W<br/>           White Glass</p> |
|---|---|--|--|---|---|

# LUCERNE



A.



B.



C.



D.



E.



F.

# LUCERNE



A.



B.



48h\*

C.



48h\*

D.



48h\*

E.



48h\*

F.



G.



H.

# LUCERNE



**A. 6-3350-16-109**  
15" Flush Mount  
Polished Nickel Finish  
15"W x 4-3/4"H  
3E 60W  
White Glass

**B. 6-3350-14-109**  
13" Flush Mount  
Polished Nickel Finish  
13-1/4"W x 4-3/4"H  
2E 60W  
White Glass

**C. 6-3350-16-13**  
15" Flush Mount  
English Bronze Finish  
15"W x 4-3/4"H  
3E 60W  
White Glass

**D. 6-3350-14-13**  
13" Flush Mount  
English Bronze Finish  
13-1/4"W x 4-3/4"H  
2E 60W  
White Glass

**E. 6-3350-16-322**  
15" Flush Mount  
Warm Brass Finish  
15"W x 4-3/4"H  
3E 60W  
White Glass

**F. 6-3350-14-322**  
13" Flush Mount  
Warm Brass Finish  
13-1/4"W x 4-3/4"H  
2E 60W  
White Glass

**G. 6-3350-16-SN**  
15" Flush Mount  
Satin Nickel Finish  
15"W x 4-3/4"H  
3E 60W  
White Glass

**H. 6-3350-14-SN**  
13" Flush Mount  
Satin Nickel Finish  
13-1/4"W x 4-3/4"H  
2E 60W  
White Glass

# CEILING

---



**A. 6-780-13-BK**  
13" Flush Mount  
Matte Black Finish  
13"W x 5"H  
2E 60W  
White Etched Glass

**B. 6-780-11-BK**  
11" Flush Mount  
Matte Black Finish  
11"W x 4-1/2"H  
2E 40W  
White Etched Glass



**A.**



**B.**

# CEILING



C.



D.



E.



F.



G.



H.



I.



J.

C. **6-780-11-SN**  
11" Flush Mount  
Satin Nickel Finish  
11"W x 4-1/2"H  
2E 40W  
White Etched Glass

D. **6-780-13-SN**  
13" Flush Mount  
Satin Nickel Finish  
13"W x 5"H  
2E 60W  
White Etched Glass

E. **6-780-13-322**  
13" Flush Mount  
Warm Brass Finish  
13"W x 5"H  
2E 60W  
White Etched Glass

F. **6-780-11-322**  
11" Flush Mount  
Warm Brass Finish  
11"W x 4-1/2"H  
2E 40W  
White Etched Glass

G. **6-780-11-13**  
11" Flush Mount  
English Bronze Finish  
11"W x 4-1/2"H  
2E 40W  
White Etched Glass

H. **6-780-13-13**  
13" Flush Mount  
English Bronze Finish  
13"W x 5"H  
2E 60W  
White Etched Glass

I. **6-780-13-109**  
13" Flush Mount  
Polished Nickel Finish  
13"W x 5"H  
2E 60W  
White Etched Glass

J. **6-780-11-109**  
11" Flush Mount  
Polished Nickel Finish  
11"W x 4-1/2"H  
2E 40W  
White Etched Glass

# RUTLAND

---



A.



C.



B.



D.



E.



# RUTLAND



**A. 9-1201-1-109**  
1-Light Sconce  
Polished Nickel Finish  
6-1/4"W x 24-1/2"H x 11-1/2"E  
1E 60W  
White Fabric Shade

**B. 9-1201-1-89**  
1-Light Sconce  
Matte Black Finish  
6-1/4"W x 24-1/2"H x 11-1/2"E  
1E 60W  
White Fabric Shade

**C. 9-1201-1-322**  
1-Light Sconce  
Warm Brass Finish  
6-1/4"W x 24-1/2"H x 11-1/2"E  
1E 60W  
White Fabric Shade

**D. 9-1201-1-44**  
1-Light Sconce  
Classic Bronze Finish  
6-1/4"W x 24-1/2"H x 11-1/2"E  
1E 60W  
White Fabric Shade

**E. 9-1201-1-SN**  
1-Light Sconce  
Satin Nickel Finish  
6-1/4"W x 24-1/2"H x 11-1/2"E  
1E 60W  
White Fabric Shade

# WAVERLY



A. 9-1200-1-SN  
1-Light Sconce  
Satin Nickel Finish  
5"W x 11"H x 6-1/2"E  
1C 60W  
White Fabric Shade

B. 9-1200-1-89  
1-Light Sconce  
Matte Black Finish  
5"W x 11"H x 6-1/2"E  
1C 60W  
White Fabric Shade

C. 9-1200-1-322  
1-Light Sconce  
Warm Brass Finish  
5"W x 11"H x 6-1/2"E  
1C 60W  
White Fabric Shade

D. 9-1200-1-13  
1-Light Sconce  
English Bronze Finish  
5"W x 11"H x 6-1/2"E  
1C 60W  
White Fabric Shade

E. 9-1200-1-109  
1-Light Sconce  
Polished Nickel Finish  
5"W x 11"H x 6-1/2"E  
1C 60W  
White Fabric Shade

# WAVERLY



A.

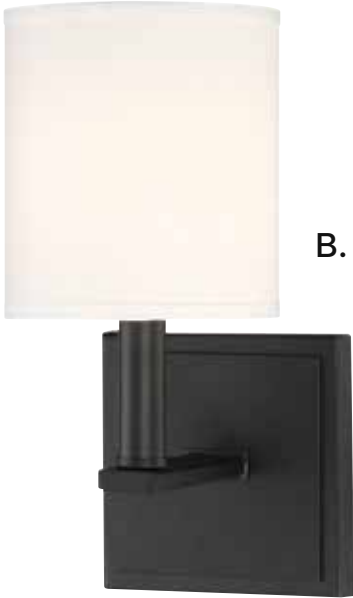

B.

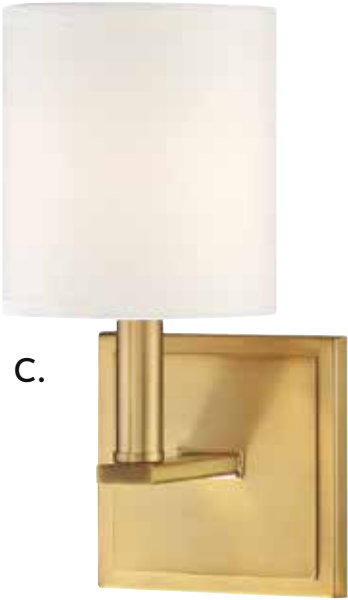

C.



D.



E.

# MONROE

---



# MONROE

**A. 9-302-1-SN**  
 1-Light Sconce  
 Satin Nickel Finish  
 5"W x 20"H x 6"E  
 1C 60W  
 White Fabric Shade  
 Metal Candle Cover

**B. 9-303-1-SN**  
 1-Light Sconce  
 Satin Nickel Finish  
 5"W x 24"H x 6-1/2"E  
 1C 60W  
 White Fabric Shade  
 Metal Candle Cover

**C. 9-7144-1-SN**  
 1-Light Sconce  
 Satin Nickel Finish  
 6-3/4"W x 33-1/2"H x 8"E  
 1C 60W  
 White Fabric Shade  
 Metal Candle Cover

**D. 9-7144-1-89**  
 1-Light Sconce  
 Matte Black Finish  
 6-3/4"W x 33-1/2"H x 8"E  
 1C 60W  
 White Fabric Shade  
 Metal Candle Cover

**E. 9-303-1-89**  
 1-Light Sconce  
 Matte Black Finish  
 5"W x 24"H x 6-1/2"E  
 1C 60W  
 White Fabric Shade  
 Metal Candle Cover

**F. 9-302-1-89**  
 1-Light Sconce  
 Matte Black Finish  
 5"W x 20"H x 6"E  
 1C 60W  
 White Fabric Shade  
 Metal Candle Cover

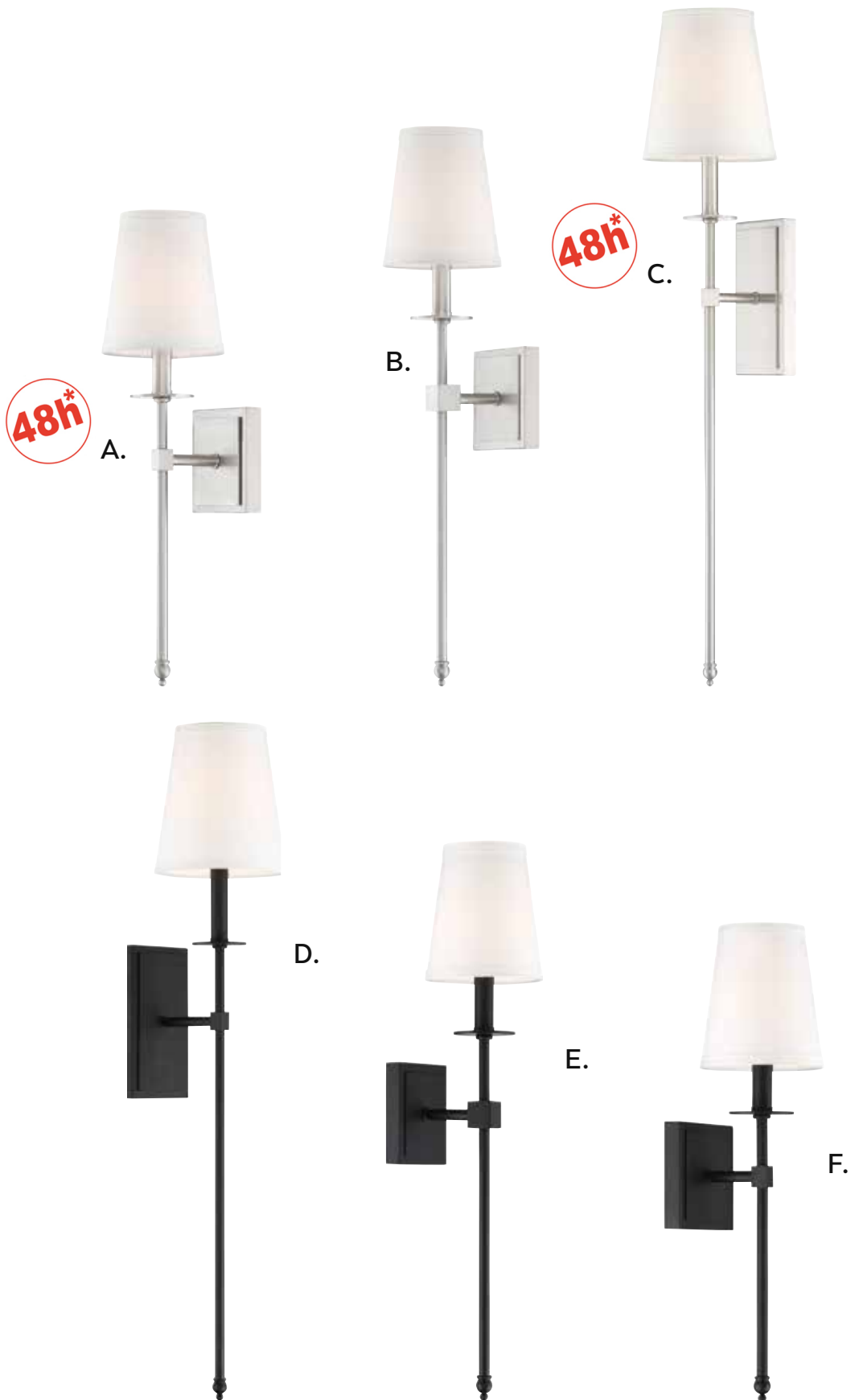

# MONROE



A.

48h\*



B.



C.

48h\*

**A. 9-7144-1-322**  
 1-Light Sconce  
 Warm Brass Finish  
 6-3/4"W x 33-1/2"H x 8"E  
 1C 60W  
 White Fabric Shade  
 Metal Candle Cover

**B. 9-303-1-322**  
 1-Light Sconce  
 Warm Brass Finish  
 5"W x 24"H x 6-1/2"E  
 1C 60W  
 White Fabric Shade  
 Metal Candle Cover

**C. 9-302-1-322**  
 1-Light Sconce  
 Warm Brass Finish  
 5"W x 20"H x 6"E  
 1C 60W  
 White Fabric Shade  
 Metal Candle Cover

**D. 9-302-1-44**  
 1-Light Sconce  
 Classic Bronze Finish  
 5"W x 20"H x 6"E  
 1C 60W  
 White Fabric Shade  
 Metal Candle Cover

**E. 9-303-1-44**  
 1-Light Sconce  
 Classic Bronze Finish  
 5"W x 24"H x 6-1/2"E  
 1C 60W  
 White Fabric Shade  
 Metal Candle Cover

**F. 9-7144-1-44**  
 1-Light Sconce  
 Classic Bronze Finish  
 6-3/4"W x 33-1/2"H x 8"E  
 1C 60W  
 White Fabric Shade  
 Metal Candle Cover

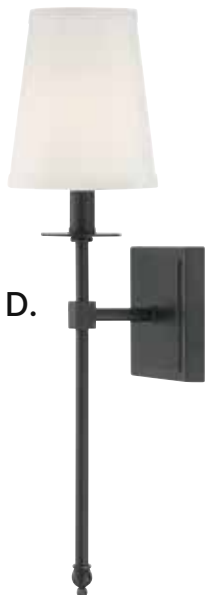

D.

48h\*



E.

48h\*



F.

# MONROE



**G. 9-7144-1-109**  
1-Light Sconce  
Polished Nickel Finish  
6-3/4"W x 33-1/2"H x 8"E  
1C 60W  
White Fabric Shade  
Metal Candle Cover

**H. 9-303-1-109**  
1-Light Sconce  
Polished Nickel Finish  
5"W x 24"H x 6-1/2"E  
1C 60W  
White Fabric Shade  
Metal Candle Cover

**I. 9-302-1-109**  
1-Light Sconce  
Polished Nickel Finish  
5"W x 20"H x 6"E  
1C 60W  
White Fabric Shade  
Metal Candle Cover



# DESTIN

---

A.



B.

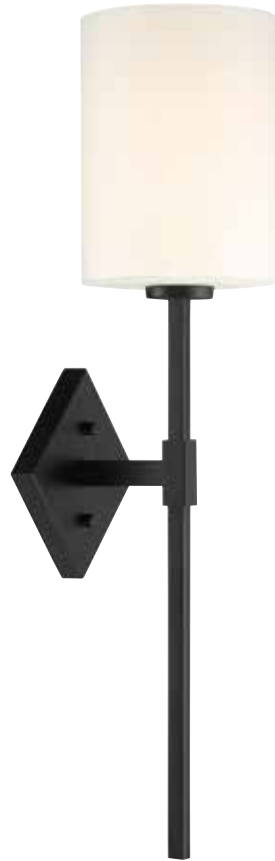

C.



D.







**A. 9-0902-1-322**  
 1-Light Sconce  
 Warm Brass Finish  
 6"W x 22"H x 7"E  
 1C 60W  
 White Opal Glass

**B. 9-0902-1-89**  
 1-Light Sconce  
 Matte Black Finish  
 6"W x 22"H x 7"E  
 1C 60W  
 White Opal Glass

**C. 9-0902-1-44**  
 1-Light Sconce  
 Classic Bronze Finish  
 6"W x 22"H x 7"E  
 1C 60W  
 White Opal Glass

**D. 9-0902-1-109**  
 1-Light Sconce  
 Polished Nickel Finish  
 6"W x 22"H x 7"E  
 1C 60W  
 White Opal Glass

# CHAPLIN



**A. 9-1000-1-109**  
1-Light Sconce  
Polished Nickel Finish  
7"W x 26"H x 8-1/2"E  
1C 60W  
White Fabric Shade  
Metal Candle Cover

**B. 9-1000-1-13**  
1-Light Sconce  
English Bronze Finish  
7"W x 26"H x 8-1/2"E  
1C 60W  
White Fabric Shade  
Metal Candle Cover

**C. 9-1000-1-322**  
1-Light Sconce  
Warm Brass Finish  
7"W x 26"H x 8-1/2"E  
1C 60W  
White Fabric Shade  
Metal Candle Cover

**D. 9-1000-1-SN**  
1-Light Sconce  
Satin Nickel Finish  
7"W x 26"H x 8-1/2"E  
1C 60W  
White Fabric Shade  
Metal Candle Cover

# CHAPLIN



A.



B.

48h\*



C.

48h\*



D.

# PAYTON

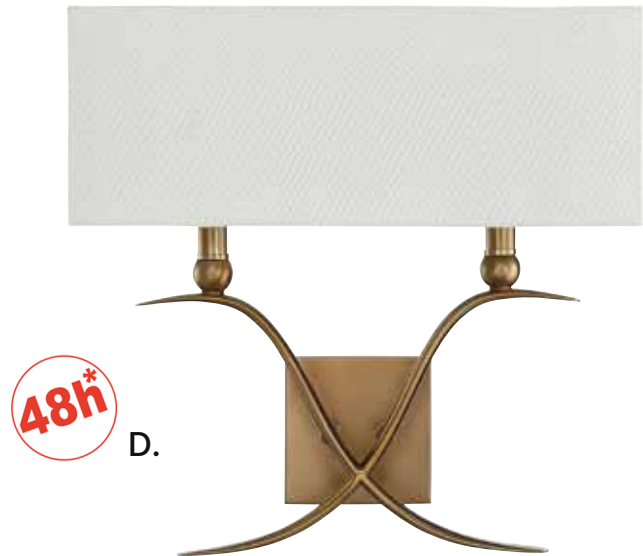
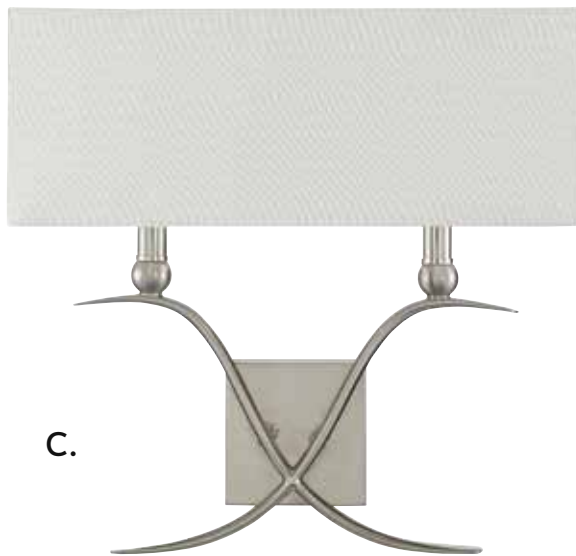
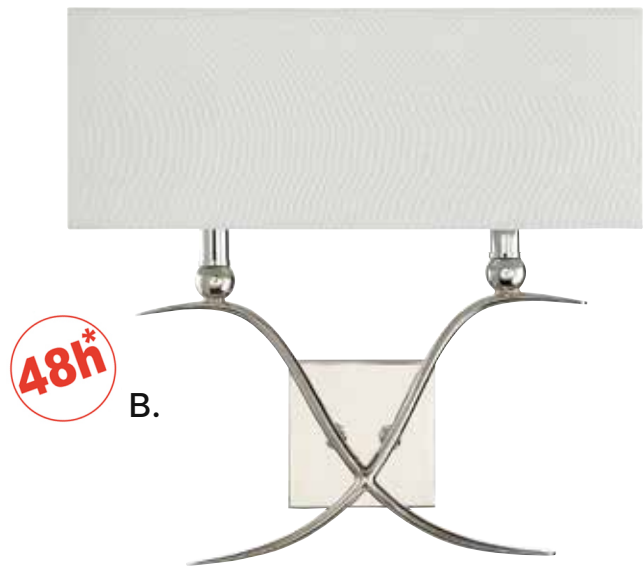
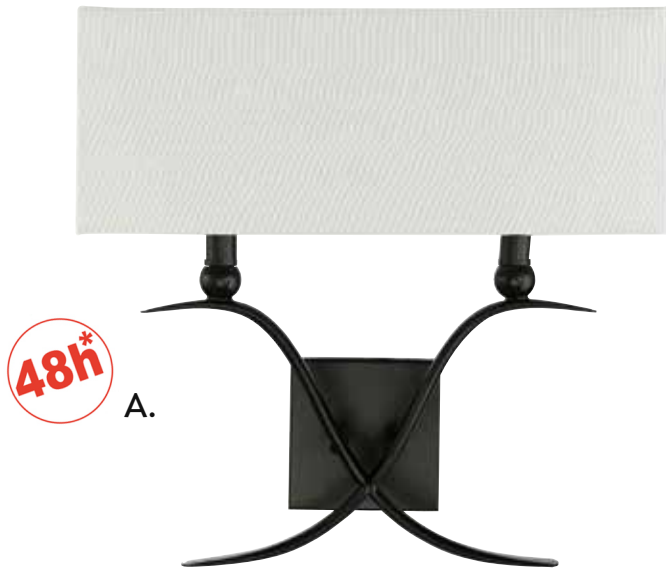

A. 9-800-2-44  
 2-Light Sconce  
 Classic Bronze Finish  
 16"W x 15-1/2"H x 6"E  
 2C 60W  
 White Linen Shade  
 Metal Candle Covers

B. 9-800-2-109  
 2-Light Sconce  
 Polished Nickel Finish  
 16"W x 15-1/2"H x 6"E  
 2C 60W  
 White Linen Shade  
 Metal Candle Covers

C. 9-800-2-SN  
 2-Light Sconce  
 Satin Nickel Finish  
 16"W x 15-1/2"H x 6"E  
 2C 60W  
 White Linen Shade  
 Metal Candle Covers

D. 9-800-2-322  
 2-Light Sconce  
 Warm Brass Finish  
 16"W x 15-1/2"H x 6"E  
 2C 60W  
 White Linen Shade  
 Metal Candle Covers

# PAYTON



# WASHBURN



**A. 9-0700-1-322**  
1-Light Sconce  
Warm Brass Finish  
7"W x 15"H x 9"E  
1C 60W  
White Linen Shade  
Metal Candle Cover

**B. 9-0700-1-109**  
1-Light Sconce  
Polished Nickel Finish  
7"W x 15"H x 9"E  
1C 60W  
White Linen Shade  
Metal Candle Cover

**C. 9-0700-1-SN**  
1-Light Sconce  
Satin Nickel Finish  
7"W x 15"H x 9"E  
1C 60W  
White Linen Shade  
Metal Candle Cover

**D. 9-0700-1-44**  
1-Light Sconce  
Classic Bronze Finish  
7"W x 15"H x 9"E  
1C 60W  
White Linen Shade  
Metal Candle Cover

# WASHBURN

A.



B.



C.



D.



# PIKE



**48h\*** A.



B.



C. **48h\***



- A. **9-16000-1-322**  
1-Light Sconce  
Warm Brass Finish  
4-1/2"W x 15-1/4"H x 4-1/2"E  
1E 60W  
Clear Ribbed Glass  
*Bulb Included 300MM T9*
- B. **9-16000-1-109**  
1-Light Sconce  
Polished Nickel Finish  
4-1/2"W x 15-1/4"H x 4-1/2"E  
1E 60W  
Clear Ribbed Glass  
*Bulb Included 300MM T9*
- C. **9-16000-1-44**  
1-Light Sconce  
Classic Bronze Finish  
4-1/2"W x 15-1/4"H x 4-1/2"E  
1E 60W  
Clear Ribbed Glass  
*Bulb Included 300MM T9*



# CLIFTON



D.



E.



F.

D. **9-900-1-322**  
1-Light Sconce  
Warm Brass Finish  
4-1/4"W x 15-1/2"H x 4-1/2"E  
1E 60W  
*Bulb Included 300MM T9*

E. **9-900-1-109**  
1-Light Sconce  
Polished Nickel Finish  
4-1/4"W x 15-1/2"H x 4-1/2"E  
1E 60W  
*Bulb Included 300MM T9*

F. **9-900-1-44**  
1-Light Sconce  
Classic Bronze Finish  
4-1/4"W x 15-1/2"H x 4-1/2"E  
1E 60W  
*Bulb Included 300MM T9*

# MERRILL



- A. 5-801-322**  
1-Light Indoor/Outdoor Sconce  
Warm Brass Finish  
8"W x 21-1/2"H x 8-1/4"E  
1E 60W  
Clear Glass  
*UL Damp Rated*
- B. 5-801-13**  
1-Light Indoor/Outdoor Sconce  
English Bronze Finish  
8"W x 21-1/2"H x 8-1/4"E  
1E 60W  
Clear Glass  
*UL Damp Rated*
- C. 5-801-SN**  
1-Light Indoor/Outdoor Sconce  
Satin Nickel Finish  
8"W x 21-1/2"H x 8-1/4"E  
1E 60W  
Clear Glass  
*UL Damp Rated*
- D. 5-800-322**  
1-Light Indoor/Outdoor Sconce  
Warm Brass Finish  
5-3/4"W x 18"H x 8"E  
1E 60W  
Clear Glass  
*UL Damp Rated*
- E. 5-800-13**  
1-Light Indoor/Outdoor Sconce  
English Bronze Finish  
5-3/4"W x 18"H x 8"E  
1E 60W  
Clear Glass  
*UL Damp Rated*
- F. 5-800-SN**  
1-Light Indoor/Outdoor Sconce  
Satin Nickel Finish  
5-3/4"W x 18"H x 8"E  
1E 60W  
Clear Glass  
*UL Damp Rated*



**DAMP**  
**Location**

# MERRILL



A.



B.



C.



D.



E.



F.

# GLENN



- A. **9-0901-1-SN**  
1-Light Adjustable Sconce  
Satin Nickel Finish  
7"W x 12"H x 9"E  
1E 60W
- B. **9-0901-1-44**  
1-Light Adjustable Sconce  
Classic Bronze Finish  
7"W x 12"H x 9"E  
1E 60W
- C. **9-0901-1-109**  
1-Light Adjustable Sconce  
Polished Nickel Finish  
7"W x 12"H x 9"E  
1E 60W
- D. **9-0901-1-322**  
1-Light Adjustable Sconce  
Warm Brass Finish  
7"W x 12"H x 9"E  
1E 60W
- E. **9-0901-1-89**  
1-Light Adjustable Sconce  
Matte Black Finish  
7"W x 12"H x 9"E  
1E 60W

# GLENN



48h\*

A.



48h\*

B.



C.



48h\*

D.



E.

# MORLAND



A.



B.

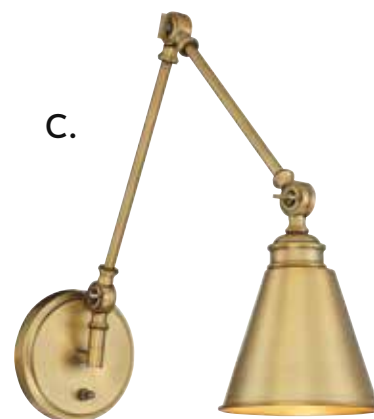

C.

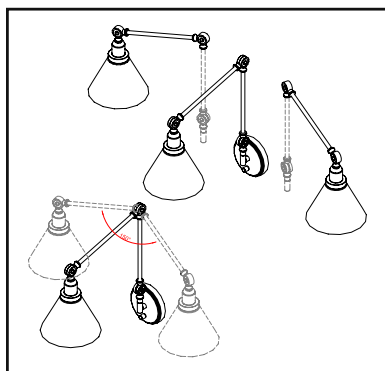

D.



E.

Switch, comes with **Cord & Plug** and **Hardwire**.

**A. 9-961CP-1-89**  
1-Light Adjustable  
Sconce  
Matte Black Finish  
6"W x 16"H x 13"E  
Adj E 13" - 33-3/4"  
1E 60W  
150° Swivel

**B. 9-961CP-1-13**  
1-Light Adjustable  
Sconce  
English Bronze Finish  
6"W x 16"H x 13"E  
Adj E 13" - 33-3/4"  
1E 60W  
150° Swivel

**C. 9-961CP-1-322**  
1-Light Adjustable  
Sconce  
Warm Brass Finish  
6"W x 16"H x 13"E  
Adj E 13" - 33-3/4"  
1E 60W  
150° Swivel

**D. 9-961CP-1-109**  
1-Light Adjustable  
Sconce  
Polished Nickel Finish  
6"W x 16"H x 13"E  
Adj E 13" - 33-3/4"  
1E 60W  
150° Swivel

**E. 9-961CP-1-SN**  
1-Light Adjustable  
Sconce  
Satin Nickel Finish  
6"W x 16"H x 13"E  
Adj E 13" - 33-3/4"  
1E 60W  
150° Swivel



F.

48h\*



G.

48h\*



H.



I.

48h\*



J.

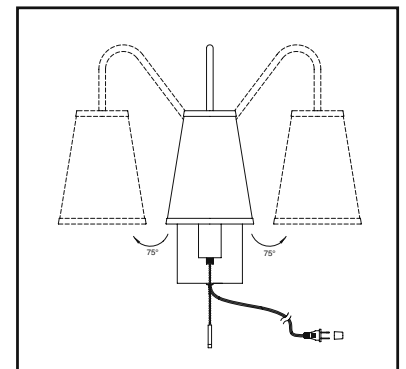

Pull-chain, comes with **Cord & Plug** and **Hardwire**.

**F. 9-0900CP-1-13**  
1-Light Adjustable Sconce  
English Bronze Finish  
6"W x 18"H x 6"E  
Adj E 6" - 12"  
1E 60W  
150° Swivel  
White Fabric Shade  
Decorative Pull-Chain ON/OFF

**G. 9-0900CP-1-322**  
1-Light Adjustable Sconce  
Warm Brass Finish  
6"W x 18"H x 6"E  
Adj E 6" - 12"  
1E 60W  
150° Swivel  
White Fabric Shade  
Decorative Pull-Chain ON/OFF

**H. 9-0900CP-1-109**  
1-Light Adjustable Sconce  
Polished Nickel Finish  
6"W x 18"H x 6"E  
Adj E 6" - 12"  
1E 60W  
150° Swivel  
White Fabric Shade  
Decorative Pull-Chain ON/OFF

**I. 9-0900CP-1-SN**  
1-Light Adjustable Sconce  
Satin Nickel Finish  
6"W x 18"H x 6"E  
Adj E 6" - 12"  
1E 60W  
150° Swivel  
White Fabric Shade  
Decorative Pull-Chain ON/OFF

**J. 9-0900CP-1-89**  
1-Light Adjustable Sconce  
Matte Black Finish  
6"W x 18"H x 6"E  
Adj E 6" - 12"  
1E 60W  
150° Swivel  
White Fabric Shade  
Decorative Pull-Chain ON/OFF

# DAKOTA



A.

48h\*



B.

48h\*

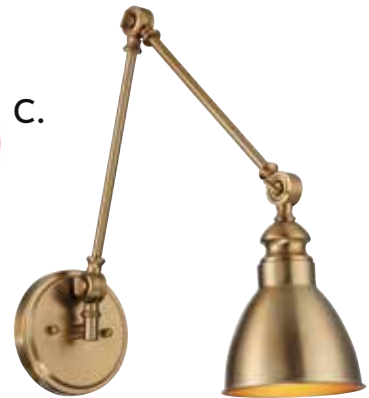

C.

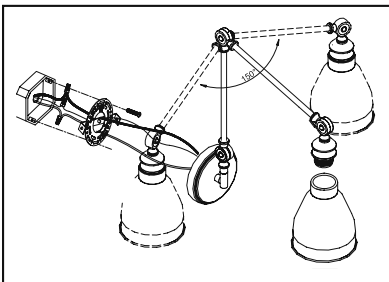

48h\*



D.



E.

Hardwire *only*.

A. 9-960-1-89  
1-Light Adjustable  
Sconce  
Matte Black Finish  
5-1/2"W x 17"H x 13"E  
Adj E 13" - 33-3/4"  
1E 60W  
150° Swivel

B. 9-960-1-13  
1-Light Adjustable  
Sconce  
English Bronze Finish  
5-1/2"W x 17"H x 13"E  
Adj E 13" - 33-3/4"  
1E 60W  
150° Swivel

C. 9-960-1-322  
1-Light Adjustable  
Sconce  
Warm Brass Finish  
5-1/2"W x 17"H x 13"E  
Adj E 13" - 33-3/4"  
1E 60W  
150° Swivel

D. 9-960-1-SN  
1-Light Adjustable  
Sconce  
Satin Nickel Finish  
5-1/2"W x 17"H x 13"E  
Adj E 13" - 33-3/4"  
1E 60W  
150° Swivel

E. 9-960-1-109  
1-Light Adjustable  
Sconce  
Polished Nickel Finish  
5-1/2"W x 17"H x 13"E  
Adj E 13" - 33-3/4"  
1E 60W  
150° Swivel



# DRAKE



F.

48h\*



G.

48h\*



H.



I.



J.

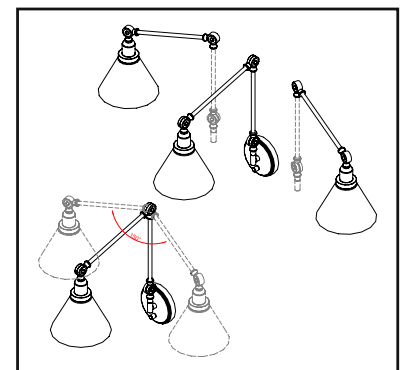

Switch, comes with **Cord & Plug** and **Hardwire**.

F. 9-9131CP-1-13  
1-Light Sconce  
English Bronze Finish  
7-1/2"W x 17"H x 14"E  
Adj E 14" - 34-1/2"  
1E 60W  
150° Swivel  
Clear Glass

G. 9-9131CP-1-322  
1-Light Sconce  
Warm Brass Finish  
7-1/2"W x 17"H x 14"E  
Adj E 14" - 34-1/2"  
1E 60W  
150° Swivel  
Clear Glass

H. 9-9131CP-1-109  
1-Light Sconce  
Polished Nickel Finish  
7-1/2"W x 17"H x 14"E  
Adj E 14" - 34-1/2"  
1E 60W  
150° Swivel  
Clear Glass

I. 9-9131CP-1-SN  
1-Light Sconce  
Satin Nickel Finish  
7-1/2"W x 17"H x 14"E  
Adj E 14" - 34-1/2"  
1E 60W  
150° Swivel  
Clear Glass

J. 9-9131CP-1-89  
1-Light Sconce  
Matte Black Finish  
7-1/2"W x 17"H x 14"E  
Adj E 14" - 34-1/2"  
1E 60W  
150° Swivel  
Clear Glass

# DELANEY

LED



**A. 8-1960-33-11**

LED Vanity  
Polished Chrome Finish  
24"W x 4-3/4"H x 3-3/4"E  
33W LED Dimmable – 2900  
Lumens, 3000K, 90 CRI  
Clear Faceted Glass



A.

**B. 8-1960-40-11**

LED Vanity  
Polished Chrome Finish  
30"W x 4-3/4"H x 3-3/4"E  
33W LED Dimmable – 2900  
Lumens, 3000K, 90 CRI  
Clear Faceted Glass



B.



C.

- C. 8-1959-53-11**  
 LED Vanity  
 Polished Chrome Finish  
 33-1/4\"/>



D.

- D. 8-1959-35-11**  
 LED Vanity  
 Polished Chrome Finish  
 23-1/4\"/>



E.

- E. 8-1959-25-11**  
 LED Vanity  
 Polished Chrome Finish  
 17-1/4\"/>



F.

- F. 8-1959-25-158**  
 LED Vanity  
 Classic Brass Finish  
 17-1/4\"/>



G.

- G. 8-1959-35-158**  
 LED Vanity  
 Classic Brass Finish  
 23-1/4\"/>



H.

- H. 8-1959-53-158**  
 LED Vanity  
 Classic Brass Finish  
 33-1/4\"/>

Fixtures may be mounted as either **Uplight** or **Downlight**.

# OCTAVE

---



# OCTAVE



A.



C.



D.



B.

**A. 8-4030-2-BK**  
2-Light Bath Bar  
Matte Black Finish  
13-3/4"W x 9"H x 5-1/2"E  
2E 60W  
Clear Glass

**B. 9-4030-1-BK**  
1-Light Sconce  
Matte Black Finish  
5"W x 9-1/2"H x 6"E  
1E 60W  
Clear Glass

**C. 8-4030-3-BK**  
3-Light Bath Bar  
Matte Black Finish  
21"W x 9"H x 5-1/2"E  
3E 60W  
Clear Glass

**D. 8-4030-4-BK**  
4-Light Bath Bar  
Matte Black Finish  
28-3/4"W x 9"H x 5-1/2"E  
4E 60W  
Clear Glass

**E. 8-4030-2-11**  
2-Light Bath Bar  
Polished Chrome Finish  
13-3/4"W x 9"H x 5-1/2"E  
2E 60W  
Clear Glass



E.



G.



H.



F.

**F. 9-4030-1-11**  
1-Light Sconce  
Polished Chrome Finish  
5"W x 9-1/2"H x 6"E  
1E 60W  
Clear Glass

**G. 8-4030-3-11**  
3-Light Bath Bar  
Polished Chrome Finish  
21"W x 9"H x 5-1/2"E  
3E 60W  
Clear Glass

**H. 8-4030-4-11**  
4-Light Bath Bar  
Polished Chrome Finish  
28-3/4"W x 9"H x 5-1/2"E  
4E 60W  
Clear Glass

Fixtures may be mounted as either **Uplight** or **Downlight**.

# OCTAVE

**A. 9-4030-1-13**

1-Light Sconce  
English Bronze Finish  
5"W x 9-1/2"H x 6"E  
1E 60W  
Clear Glass



**48h\***

**B. 8-4030-2-13**

2-Light Bath Bar  
English Bronze Finish  
13-3/4"W x 9"H x 5-1/2"E  
2E 60W  
Clear Glass

**B.**



**C. 8-4030-3-13**

3-Light Bath Bar  
English Bronze Finish  
21"W x 9"H x 5-1/2"E  
3E 60W  
Clear Glass

**C.**



**D. 8-4030-4-13**

4-Light Bath Bar  
English Bronze Finish  
28-3/4"W x 9"H x 5-1/2"E  
4E 60W  
Clear Glass

**D.**



**E. 9-4030-1-322**

1-Light Sconce  
Warm Brass Finish  
5"W x 9-1/2"H x 6"E  
1E 60W  
Clear Glass



**48h\***

**F. 8-4030-2-322**

2-Light Bath Bar  
Warm Brass Finish  
13-3/4"W x 9"H x 5-1/2"E  
2E 60W  
Clear Glass

**F.**



**G. 8-4030-3-322**

3-Light Bath Bar  
Warm Brass Finish  
21"W x 9"H x 5-1/2"E  
3E 60W  
Clear Glass

**E.**



**G.**

**H. 8-4030-4-322**

4-Light Bath Bar  
Warm Brass Finish  
28-3/4"W x 9"H x 5-1/2"E  
4E 60W  
Clear Glass

**H.**



Fixtures may be mounted as either **Uplight** or **Downlight**.

# OCTAVE



- I. **8-4030-2-SN**  
2-Light Bath Bar  
Satin Nickel Finish  
13-3/4"W x 9"H x 5-1/2"E  
2E 60W  
Clear Glass
- J. **9-4030-1-SN**  
1-Light Sconce  
Satin Nickel Finish  
5"W x 9-1/2"H x 6"E  
1E 60W  
Clear Glass
- K. **8-4030-3-SN**  
3-Light Bath Bar  
Satin Nickel Finish  
21"W x 9"H x 5-1/2"E  
3E 60W  
Clear Glass
- L. **8-4030-4-SN**  
4-Light Bath Bar  
Satin Nickel Finish  
28-3/4"W x 9"H x 5-1/2"E  
4E 60W  
Clear Glass



I.



J.



K.



L.

# DRAKE

---

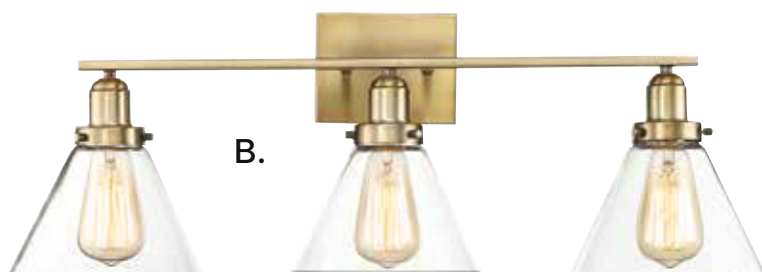

Fixtures may be mounted as either **Uplight** or **Downlight**.





- |   |   |   |   |   |   |
|---|---|---|---|---|---|
| <p><b>A. 8-9130-4-322</b><br/>4-Light Bath Bar<br/>Warm Brass Finish<br/>38"W x 10"H x 7-1/2"E<br/>4E 60W<br/>Clear Glass</p> | <p><b>B. 8-9130-3-322</b><br/>3-Light Bath Bar<br/>Warm Brass Finish<br/>28-1/2"W x 10"H x<br/>7-1/2"E<br/>3E 60W<br/>Clear Glass</p> | <p><b>C. 8-9130-2-322</b><br/>2-Light Bath Bar<br/>Warm Brass Finish<br/>17-3/4"W x 10"H x<br/>7-1/2"E<br/>2E 60W<br/>Clear Glass</p> | <p><b>D. 8-9130-2-BK</b><br/>2-Light Bath Bar<br/>Matte Black Finish<br/>17-3/4"W x 10"H x<br/>7-1/2"E<br/>2E 60W<br/>Clear Glass</p> | <p><b>E. 8-9130-3-BK</b><br/>3-Light Bath Bar<br/>Matte Black Finish<br/>28-1/2"W x 10"H x<br/>7-1/2"E<br/>3E 60W<br/>Clear Glass</p> | <p><b>F. 8-9130-4-BK</b><br/>4-Light Bath Bar<br/>Matte Black Finish<br/>38"W x 10"H x 7-1/2"E<br/>4E 60W<br/>Clear Glass</p> |
|---|---|---|---|---|---|

# DRAKE



- |  |  |  |  |  |  |
|--|--|--|--|--|--|
| <p><b>A. 8-9130-4-109</b><br/>4-Light Bath Bar<br/>Polished Nickel Finish<br/>38"W x 10"H x 7-1/2"E<br/>4E 60W<br/>Clear Glass</p> | <p><b>B. 8-9130-3-109</b><br/>3-Light Bath Bar<br/>Polished Nickel Finish<br/>28-1/2"W x 10"H x<br/>7-1/2"E<br/>3E 60W<br/>Clear Glass</p> | <p><b>C. 8-9130-2-109</b><br/>2-Light Bath Bar<br/>Polished Nickel Finish<br/>17-3/4"W x 10"H x<br/>7-1/2"E<br/>2E 60W<br/>Clear Glass</p> | <p><b>D. 8-9130-2-13</b><br/>2-Light Bath Bar<br/>English Bronze Finish<br/>17-3/4"W x 10"H x<br/>7-1/2"E<br/>2E 60W<br/>Clear Glass</p> | <p><b>E. 8-9130-3-13</b><br/>3-Light Bath Bar<br/>English Bronze Finish<br/>28-1/2"W x 10"H x<br/>7-1/2"E<br/>3E 60W<br/>Clear Glass</p> | <p><b>F. 8-9130-4-13</b><br/>4-Light Bath Bar<br/>English Bronze Finish<br/>38"W x 10"H x 7-1/2"E<br/>4E 60W<br/>Clear Glass</p> |
|--|--|--|--|--|--|

# DRAKE



Fixtures may be mounted as either **Uplight** or **Downlight**.

# CALHOUN

---



# CALHOUN



A.

- A. 8-1020-4-SN**  
4-Light Bath Bar  
Satin Nickel Finish  
32"W x 8-3/4"H x 6-3/8"E  
4E 60W  
Clear Glass



B.

- B. 8-1020-3-SN**  
3-Light Bath Bar  
Satin Nickel Finish  
24"W x 8-3/4"H x 6-3/8"E  
3E 60W  
Clear Glass



C.

- C. 8-1020-2-SN**  
2-Light Bath Bar  
Satin Nickel Finish  
14-5/8"W x 8-3/4"H x 6-3/8"E  
2E 60W  
Clear Glass



D.

- D. 8-1020-2-BK**  
2-Light Bath Bar  
Matte Black Finish  
14-5/8"W x 8-3/4"H x 6-3/8"E  
2E 60W  
Clear Glass

- E. 8-1020-3-BK**  
3-Light Bath Bar  
Matte Black Finish  
24"W x 8-3/4"H x 6-3/8"E  
3E 60W  
Clear Glass

- F. 8-1020-4-BK**  
4-Light Bath Bar  
Matte Black Finish  
32"W x 8-3/4"H x 6-3/8"E  
4E 60W  
Clear Glass



E.



F.

Fixtures may be mounted as either **Uplight** or **Downlight**.

# MELROSE



**A. 8-6836-2-322**

2-Light Bath Bar  
Warm Brass Finish  
14-1/2"W x 7-3/4"H x 6-3/4"E  
2E 60W  
White Opal Etched Glass

**B. 8-6836-3-322**

3-Light Bath Bar  
Warm Brass Finish  
24"W x 7-3/4"H x 6-3/4"E  
3E 60W  
White Opal Etched Glass

**C. 8-6836-4-322**

4-Light Bath Bar  
Warm Brass Finish  
33-1/2"W x 7-3/4"H x 6-3/4"E  
4E 60W  
White Opal Etched Glass

**D. 9-6836-1-322**

1-Light Sconce  
Warm Brass Finish  
5"W x 7-3/4"H x 6-3/4"E  
1E 60W  
White Opal Etched Glass

# MELROSE

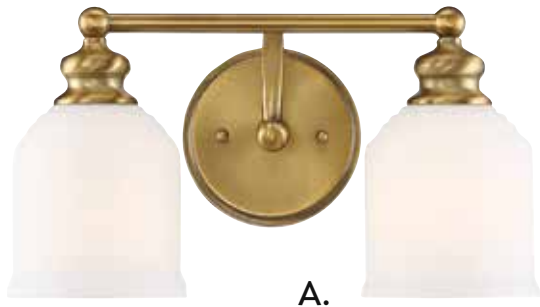

A.



B.



C.



D.

Fixtures may be mounted as either Uplight or Downlight.

  
BRIAN THOMAS  
COLLECTION



E.



F.



G.



H.

Fixtures may be mounted as either Uplight or Downlight.

  
BRIAN THOMAS  
COLLECTION

E. 8-6836-2-SN  
2-Light Bath Bar  
Satin Nickel Finish  
14-1/2"W x 7-3/4"H x 6-3/4"E  
2E 60W  
White Opal Etched Glass

F. 8-6836-3-SN  
3-Light Bath Bar  
Satin Nickel Finish  
24"W x 7-3/4"H x 6-3/4"E  
3E 60W  
White Opal Etched Glass

G. 8-6836-4-SN  
4-Light Bath Bar  
Satin Nickel Finish  
33-1/2"W x 7-3/4"H x 6-3/4"E  
4E 60W  
White Opal Etched Glass

H. 9-6836-1-SN  
1-Light Sconce  
Satin Nickel Finish  
5"W x 7-3/4"H x 6-3/4"E  
1E 60W  
White Opal Etched Glass

# MELROSE



A.



B.



C.



D.

Fixtures may be mounted as either Uplight or Downlight.

  
**BRIAN THOMAS**  
 COLLECTION



E.



F.



G.



H.

Fixtures may be mounted as either Uplight or Downlight.

  
**BRIAN THOMAS**  
 COLLECTION

A. **8-6836-2-13**  
 2-Light Bath Bar  
 English Bronze Finish  
 14-1/2"W x 7-3/4"H x 6-3/4"E  
 2E 60W  
 White Opal Etched Glass

B. **8-6836-3-13**  
 3-Light Bath Bar  
 English Bronze Finish  
 24"W x 7-3/4"H x 6-3/4"E  
 3E 60W  
 White Opal Etched Glass

C. **8-6836-4-13**  
 4-Light Bath Bar  
 English Bronze Finish  
 33-1/2"W x 7-3/4"H x 6-3/4"E  
 4E 60W  
 White Opal Etched Glass

D. **9-6836-1-13**  
 1-Light Sconce  
 English Bronze Finish  
 5"W x 7-3/4"H x 6-3/4"E  
 1E 60W  
 White Opal Etched Glass





**E. 8-6836-2-11**  
 2-Light Bath Bar  
 Polished Chrome Finish  
 14-1/2"W x 7-3/4"H x 6-3/4"E  
 2E 60W  
 White Opal Etched Glass

**F. 8-6836-3-11**  
 3-Light Bath Bar  
 Polished Chrome Finish  
 24"W x 7-3/4"H x 6-3/4"E  
 3E 60W  
 White Opal Etched Glass

**G. 8-6836-4-11**  
 4-Light Bath Bar  
 Polished Chrome Finish  
 33-1/2"W x 7-3/4"H x 6-3/4"E  
 4E 60W  
 White Opal Etched Glass

**H. 9-6836-1-11**  
 1-Light Sconce  
 Polished Chrome Finish  
 5"W x 7-3/4"H x 6-3/4"E  
 1E 60W  
 White Opal Etched Glass



# FINISH GUIDE

02	.....	OILED BRONZE	100	.....	AURORA
05	.....	OILED COPPER	101	.....	NOBLEWOOD W/ IRON
8	.....	NEW TORTOISE SHELL W/ SILVER	103	.....	VINTAGE BRASS
11	.....	POLISHED CHROME	106	.....	CHROME AND METALLIC BRONZE
12	.....	CHATEAU LINEN	107	.....	BRONZE AND CHROME W/ ANTIQUE MIRROR ACCENTS
13	.....	ENGLISH BRONZE	109	.....	POLISHED NICKEL
14	.....	RAW STEEL	111	.....	SATIN NICKEL W/ POLISHED NICKEL ACCENTS
16	.....	ANTIQUÉ COPPER	112	.....	WEATHERED BIRCH
21	.....	BURNISHED RUSSET	115	.....	RUSTIC BLACK W/ ROPE
23	.....	WHITE WASHED DRIFTWOOD	116	.....	FARMHOUSE TIN
25	.....	SLATE	118	.....	CHARISMA
27	.....	INDUSTRIAL STEEL	119	.....	SMOKE
28	.....	OILED BURNISHED BRONZE	120	.....	PROVINCIAL WOOD W/ EBONY
30	.....	CARBON W/ WARM BRASS ACCENTS	121	.....	MOHICAN BRONZE
31	.....	FLAT BLACK	122	.....	GOLD DUST
32	.....	ARTISAN RUST	123	.....	WHITE W/ SILVER LEAF
33	.....	GOLD BULLION	124	.....	FIESTA BRONZE
34	.....	SILVER LEAF	126	.....	BLACK W/ GOLD LEAF
39	.....	FOSSIL STONE	127	.....	NOBLE BRASS
40	.....	WALNUT PATINA	128	.....	OXIDIZED SILVER
41	.....	DURANGO	129	.....	ESPRESSO
42	.....	GALAXY BRONZE	132	.....	MOONLIT BARK
44	.....	CLASSIC BRONZE	135	.....	TEXTURED WHITE W/ SILVER LEAF
45	.....	AGED WOOD	136	.....	TEXTURED BLACK W/ GOLD LEAF
49	.....	WINTERWOOD	139	.....	PEWTER AND GREYWOOD
50	.....	HARNES LEATHER W/ RUBBED BRASS	140	.....	MISTY SKY
51	.....	VINTAGE BLACK W/ WARM BRASS FINISH	141	.....	TEXTURED BRONZE W/ GOLD HIGHLIGHTS
52	.....	BARK & GOLD	144	.....	SATIN NICKEL W/ CHROME ACCENTS
53	.....	SILVER PATINA	145	.....	MATTE BLACK W/ SATIN NICKEL ACCENTS
54	.....	GOLD PATINA	147	.....	CASTILLO
56	.....	NEW TORTOISE SHELL	148	.....	ESTATE BRASS
57	.....	POLISHED PEWTER	149	.....	WEATHERED ASH
60	.....	AVALITE	150	.....	BLACK STEEL
61	.....	BRONZE ORE	152	.....	MONACO
62	.....	COMO BLACK W/ GOLD	158	.....	CLASSIC BRASS
63	.....	WARM BRASS LUSTRE	176	.....	SILVER LACE
64	.....	FIELDSTONE	187	.....	BRUSHED PEWTER
67	.....	MATTE BLACK W/ POLISHED CHROME ACCENTS	196	.....	RECLAIMED WOOD
68	.....	WHISKEY WOOD	211	.....	ARGENTUM
69	.....	PEWTER	212	.....	ARGENTUM & GOLD
70	.....	WEATHERVANE	213	.....	ENGLISH BRONZE W/ GOLD
72	.....	RUSTIC BRONZE	242	.....	AGED STEEL
73	.....	POLISHED NICKEL W/ WOOD ACCENTS	272	.....	SILVER DUST
76	.....	FLORENCIAN BRONZE	307	.....	SILVER SPARKLE
77	.....	BRONZE W/ BRASS ACCENTS	322	.....	WARM BRASS
79	.....	ENGLISH BRONZE AND WARM BRASS	323	.....	OLD BRONZE
80	.....	MATTE WHITE	330	.....	TEXTURED BRONZE
82	.....	PORCELLANA	BK/BLK	.....	BLACK
84	.....	RUBBED BRONZE W/ GOLD LEAF	BN	.....	BROWNSTON
85	.....	RUBBED ZINC W/ SILVER LEAF	CH	.....	CHROME
87	.....	WOODLAND BRONZE	FB	.....	FLAT BLACK
88	.....	OXIDIZED BLACK	SN	.....	SATIN NICKEL
89	.....	MATTE BLACK	WH/WHT	.....	WHITE
90	.....	GALVANIZED METAL			
95	.....	WARM BRASS W/ BRONZE ACCENTS			
96	.....	BARRELWOOD W/ BRASS ACCENTS			
98	.....	PYRITE			

S  
A  
V  
O  
Y  
  
H  
O  
U  
S  
E



3130 North Berkeley Lake Road NW ♦ Duluth, GA 30096  
800 801 1621 TEL 404 890 7540 ♦ FAX 877 547 2869  
SavoyHouse.com