

OUTDOOR



OUTDOOR

martinelli luce







index

KIKI Pag. 6



CIULIFRULI Pag. 16



TRILLY Pag. 24



GLOUGLOU POL Pag. 30



BOWL Pag. 36



BICONICA POL Pag. 40



PISTILLO Pag. 44



CYBORG Pag. 48



PONT Pag. 52



BOLETO Pag. 56



BRUCO Pag. 58



KOALA Pag. 64



PLAN Pag. 66



OUT Pag. 68



POLO Pag. 72



2250 Pag. 78



- **BI** bianco / withe / blanc
- **GR** grigio / gray / gris /
- **AZ** azzurro / light blue / bleu clair
- **VE** verde / green / vert
- **RO** rosso / red / rouge
- **NE** nero / black / noir
- **AN** antracite / anthracite / anthracite
- **GI** giallo / yellow / jaune
- **CO** corten / corten / corten

OUTDOOR





KIKI



KIKI



Catenaria di luce Kiki lampada a sospensione, per esterno, formata da 3, 5 o 10 punti luce fissati alla distanza di cm 100 uno dall'altro sul cavo elettrico.

Disponibile in tre versioni: con lunghezza del cavo di mt 8 predisposto per 3 punti luce, di mt 10 per 5 punti luce, e di mt 15,00 per 10 punti luce.

Il supporto è stampato in resina e gomma nel colore nero ed è cablato per lampadina a Led, il diffusore è in polietilene stampato in rotazionale.

Due supporti all'estremità del cavo permettono di sospendere e fissare la catenaria.

Il cavo di alimentazione è dotato di una spina da esterno IP44. Kiki è utile per illuminare il proprio giardino e gli spazi all'aperto, creando giochi di luce, angoli funzionali e percorsi illuminati piacevoli da vivere.

IP65

Kiki chain of hanging lights for outdoor use comprised of 3, 5 or 10 light points fixed at a distance of 100 cm one from the other on the electrical cable.

Available in three versions: 8-meter cable length pre-arranged for 3 light points and 10 meter cable length for 5 light points and 15-meter cable for 10 light points.

The support is molded in resin and rubber, black, and cabled for LED bulbs.

The diffusor is in rotomolded polyethylene. The power cable is equipped with an outdoor plug IP44. Two supports at the ends of the cable allow to suspend and fix the chain.

The Kiki lamp allows illuminating a garden and open spaces, creating light effects, functional corners and lighted paths, for a pleasant living experience.

Chaîne de lampes d'extérieur à suspension se composant de 3, 5 à 10 éléments espacés tous les 100 cm. Elle est proposée dans trois versions: avec un câble de 8 m de longueur, prévu pour 3 points d'éclairage ou bien avec un câble de 10 m de longueur prévu pour 5 points d'éclairage ou un câble de 15 m pour 10 points d'éclairage.

Le support est en résine et en caoutchouc moulé couleur noir et il est câblé pour des ampoules à Led.

Le diffuseur est en polyéthylène roto moulé. Deux crochets se trouvent à chaque extrémité du câble pour suspendre la chaîne de lampes. Le câble d'alimentation est doté d'une prise pour l'extérieur IP44. La lampe Kiki est en mesure d'éclairer votre jardin et les espaces en plein air. Elle est parfaite pour créer des jeux de lumière, des emplacements fonctionnels mais aussi pour éclairer des allées agréables à vivre.

21004/3/NE

3x5.3W E27 LED
Ø14.5 H 18.5 L 8m



21004/5/NE

5x5.3W E27 LED
Ø14.5 H 18.5 L 10m



21004/10/NE

10x5.3W E27 LED
Ø14.5 H 18.5 L 15m





FIG. 1

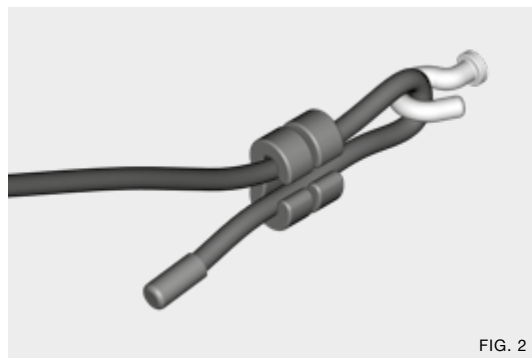

FIG. 2



FIG. 3

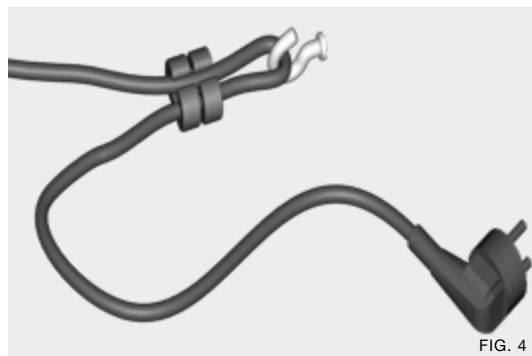
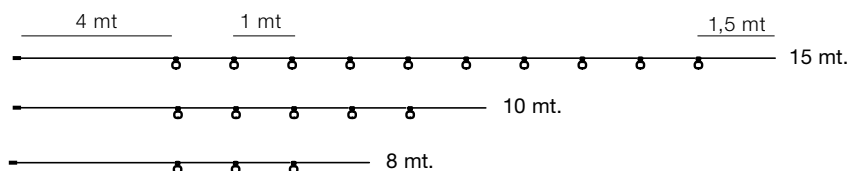

FIG. 4



Punto luce fissato al cavo di alimentazione (vedi fig. 1)
Light point fitted on the power cable (see fig. 1)
Luminaire fixé au cordon d'alimentation (voir figure 1)

Particolare del terminale di fissaggio per l'aggancio a parete dell'estremità del cavo di alimentazione senza spina (vedi fig. 2)
Detail of the fixing terminal to hook the end of the power cable to the wall without a plug.
Détails de la partie terminale de fixation servant à accrocher au mur l'extrémité du cordon d'alimentation sans prise électrique (voir figure 2)

Punto luce appeso con gancio optional cod. 40054/NE per il fissaggio ad un cavo teso in acciaio (vedi fig. 3)
Light point hanging with hook optional code 40054/NE for fixing to a taut steel cable (see fig. 3)
Luminaire avec crochet de suspension en option (code 40054/NE) pour le fixer à un câble tendu en acier (voir figure 3)

Particolare del terminale di fissaggio per l'aggancio a parete dell'estremità del cavo di alimentazione completo di spina (vedi fig. 4)
Detail of the fixing terminal to hook the end of the power cable to the wall complete with plug (see fig.4)
Détails de la partie terminale de fixation servant à accrocher au mur l'extrémité du cordon d'alimentation muni d'une prise (voir figure 4)

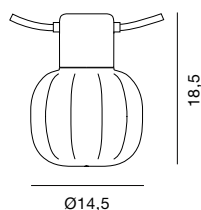









KIKI CORDLESS



21004/DIM/CL/NE

Ø 14,5 H 16

1W LED A++ 

Lampada a luce diffusa per esterno cordless. Supporto stampato in resina e gomma, cablato per lampadina a Led, diffusore in polietilene stampato in rotazionale, maniglia intercambiabile in silicone nei colori: rosso, nero, grigio-verde. Batteria ricaricabile, con cavo USB, durata batteria 7 ore. Caricabatteria USB a richiesta.

Diffused cordless light lamp for outdoor. Resin and rubber support for Led bulb. Rotational polyethylene printed diffuser ,with rechargeable silicone handle in red, black or green-grey colors . Rechargeable battery, with USB cable, battery life 7 hours. Charger supplied on request.

Lampe cordless à lumière diffusee for outdoor. Support imprimé en résine et caoutchouc, cablé pour ampoule Led. Diffuseur en polyéthylène. Poignée en silicone dans les couleurs rouge, noir, gris-vert. Batterie rechargeable, avec câble USB, durée de la batterie: 7 heures. Chargeur de batterie sur demande.

IP65

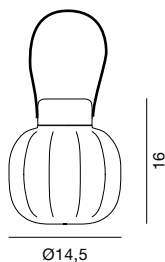

La lampada è completa di maniglia intercambiabile in silicone nei colori nero, rosso o grigio (include).

Lamp is complete with interchangeable silicone handle in black, red, gray or green (included).

La lampe est complète avec une poignée en silicone interchangeable dans les couleurs rouge, noir et gris (include).





CIULIFRULI



CIULIFRULI

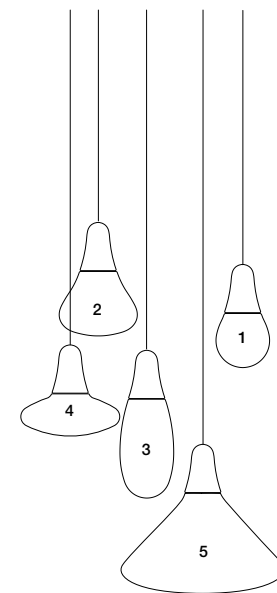

Diffusore bianco.
Diffuser white.
Diffuseur blanc.

30859/BI	Ø16	H16	1
30860/BI	Ø23	H19	2
30861/BI	Ø16	H29	3
30862/BI	Ø29	H12,5	4
30903/BI	Ø50	H40	5

Supporto colorato con cavo arancione e spina cablato per l'esterno.
Coloured support with an orange cable and plug wired for outdoor.
Support coloré avec câble orange et fiche câblé pour usage extérieur.

30858/GI	Ø10	H14	
30858/AZ	Ø10	H14	
30858/VE	Ø10	H14	
30858/RO	Ø10	H14	
30858/BI	Ø10	H14	

Lampada a sospensione per esterno o interno a luce diffusa, materiale polietilene stampato in rotazionale. Formata da un supporto in 5 colori e da un diffusore bianco intercambiabile in 5 diverse forme e dimensioni. Per lampada a LED. Spina IP44.

Swinging lamp for outdoor or indoor with diffused light made of rotational polyethylene printed material. It consists of a support in 5 colours and in a white interchangeable diffuser in 5 different sizes and shapes. For LED bulb. Plug IP44.

Lampadaire pour usage extérieur ou intérieur avec lumière diffusée, fait en matériel polyéthylène imprimé en rotation. Il est formé par un support en 5 couleurs et par un diffuseur blanc interchangeable en 5 formes et dimensions différentes. Pour lampes à LED. Fiche IP44.

lampadina per diffusori..
bulb for diffusers...
ampoule pour diffuseurs ..
mod. 1-2-3-5

5049	10W	E27	LED
5278	14W	E27	LED

lampadina per diffusore..
bulb for diffuser...
ampoule pour diffuseur ...
mod. 4
5056 5,3W E27 LED

IP65

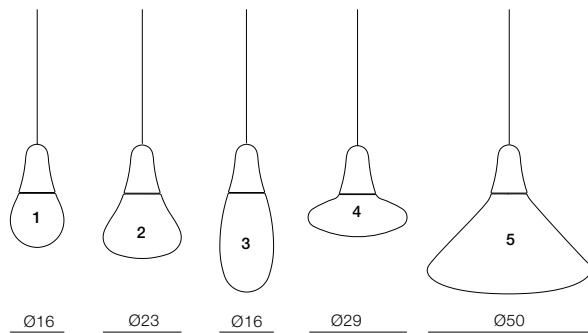





Biennale dell'architettura, Arsenali Repubblicani, Pisa

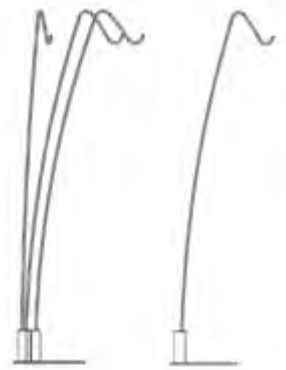

40039/3

40039/1

Base e supporto
per 1 lampada
Base and support
for 1 lamp
Base et support
pour 1 lampe

40039/1 Ø50 H223

Base e supporti
per 3 lampade
Base and supports
for 3 lamps
Base et supports
pour 3 lampes

40039/3 Ø50 H223



Biennale dell'architettura, Arsenali Repubblicani, Pisa



A glowing white, fan-shaped light fixture hangs from a red cord in a bamboo forest. The light fixture is a simple, white, fan-like shape with a circular hole at the top. It is illuminated from within, creating a bright, warm glow. The red cord is tied to a bamboo stalk and loops around it. The background is a dense forest of bamboo stalks, with some light filtering through the leaves, creating a soft, natural atmosphere.

TRILLY

EMILIANA MARTINELLI 2011

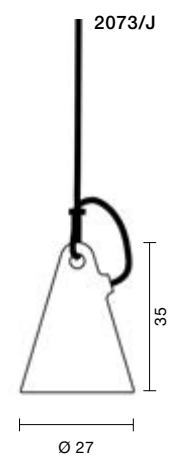
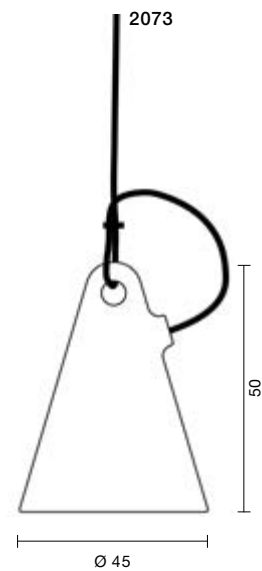



Lampada a sospensione, parete o da appoggio per esterno a luce diffusa, struttura in polietilene stampato in rotazionale. Per lampada a LED ,con cavo arancione mt. 3 e spina da esterno IP44. Disponibile in due misure.

Hanging, wall or ground outdoor lamp, diffused light. Rotational moulding in polyethylene material. For LED bulb, orange cable and plug for outdoor IP44. Available in two sizes.

Lampe à suspension ou à poser au sol avec lumière diffuse, moulé par rotation, en polyéthylène blanc. Pour lampe à LED. Avec 5 mètres de câble orangier pour l'extérieur et fiche IP44. Deux tailles.

IP65



2073 Ø 45 H50 1x15W E27 LED 
2073/J Ø 27 H36 1x 6 W E27 LED 

30837 Gancio per attacco a parete
Hook for wall mounting
Crochet pour montage mural









GLOUGLOU POL



GLOUGLOU POL FLOATING





Lampada galleggiante per esterno a luce diffusa, stampata in rotazionale materiale polietilene. Per sorgente di luce a LED, batteria inclusa ricaricabile e telecomando durata 6 ore.

Floating outdoor lamp, diffused light rotational moulded polyethylene material. For LED light source, rechargeable battery included, and remote control, life 6 hours.

Lampe flottante pour usage extérieur avec lumière diffusée imprimée en rotation en polyéthylène. Pour des sources de lumière LED, batterie incluse rechargeable et télécommandé, 6 heures

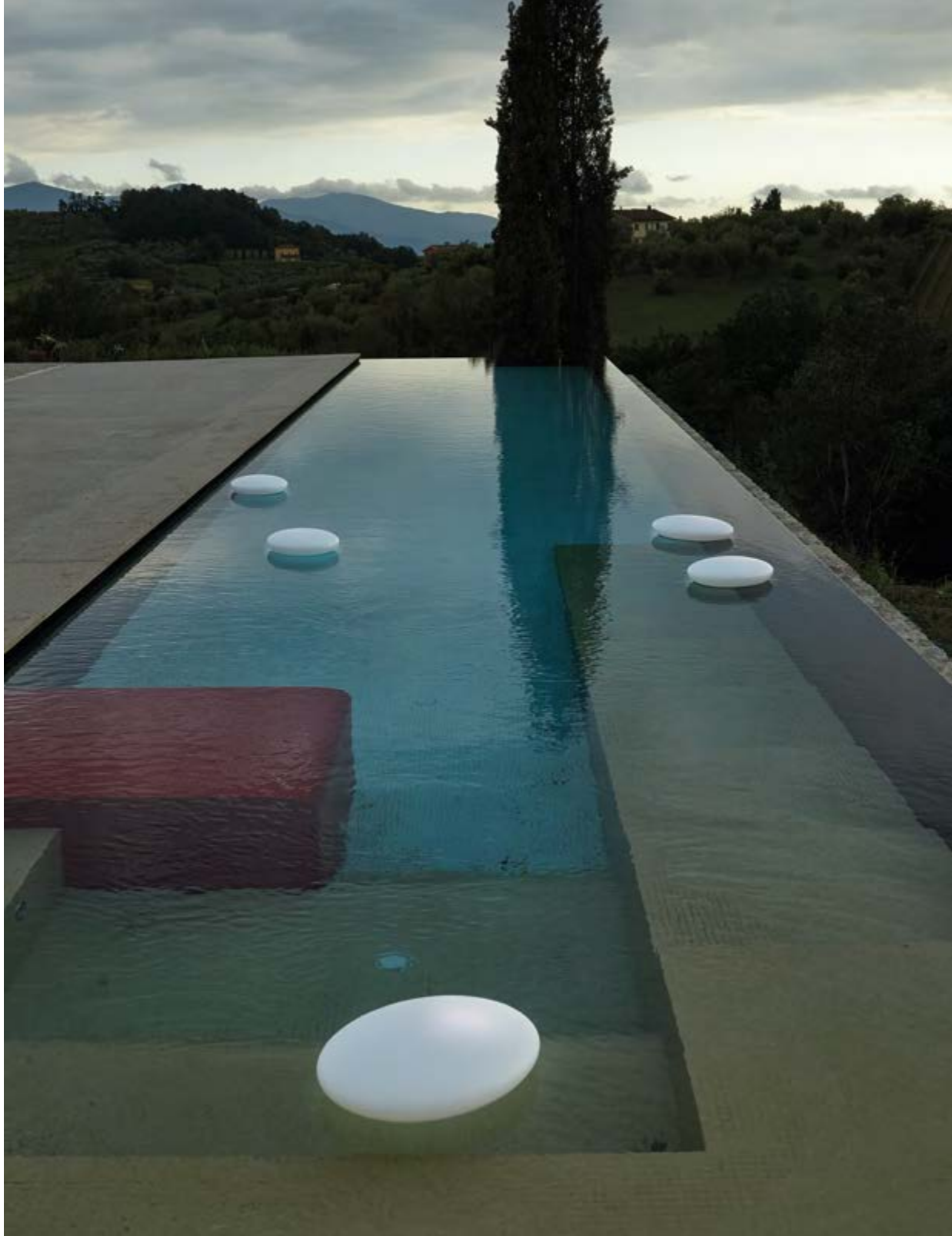
IP65



822 40x50 H15 1x1,5W LED RGB 

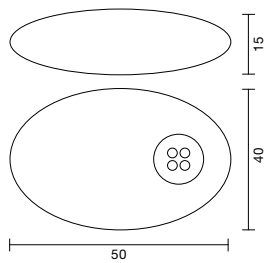

GLOUGLOU POL



Lampada da appoggio per esterno a luce diffusa stampata in rotazionale materiale polietilene bianco. Con cavo arancione 3 mt, e spina da esterno IP44, per lampada a LED.

Standing outdoor lamp, diffused light rotational moulded white polyethylene material, with orange cable 3 mt. and plug IP44 for outdoor, LED bulb.

Lampe a lumière diffusée, moulée par rotation, en polyéthylène blanc, avec câble orange 3 metres et fiche IP44 pour l'extérieur. Pour lampe à LED.

IP65



821/BI 40x50 H15 1x6W E14 LED 

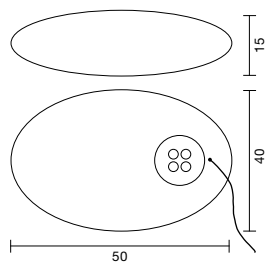



BOWL



BOWL



Lampada versatile da appoggio da esterno o interno, a luce diffusa, struttura stampata in rotazionale, materiale polietilene bianco, con particolare maniglia stampata in resina. Cavo mt 3 con spina IP44, per lampada a LED.

IP65

Adaptable outdoor or indoor lamp, diffused light, white polyethylene material rotational moulded, with particular support in resin. With cable mt 3 and plug IP44. For LED.

Lampe polyvalente à poser au sol, pour intérieur et extérieur à lumière diffusée. Diffuseur en polyéthylène, moulé par rotation 3m de câble pour l'extérieur et fiche IP44, pour ampoule à LED.



812 Ø 35 1x15W E27 LED 

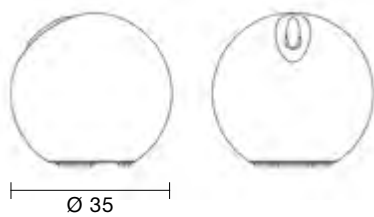



BICONICA POL





2217/POL/P/BD/L/1
 70W LED 5320 lm
 2400-6500K
 Con telecomando
 With remote control
 Avec télécommande



2217/POL/P/BD/BT/L/1
 70W LED 5320 lm
 2400-6500K
 bluetooth
 Casambi tecnologia
 dimmerabile dimmable



2217/POL/P/BT/L
 105W LED RGB
 bluetooth
 Casambi tecnologia
 dimmerabile dimmable

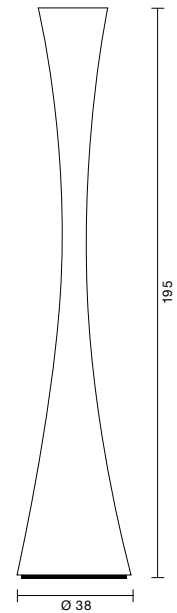

Lampada da terra a luce diffusa, struttura stampata in rotazionale, materiale polietilene bianco. Per sorgente di luce a LED nel colore bianco o RGB. Completa di alimentatori dimmerabili e con 3 mt di cavo e spina IP44 per esterno.

IP65

Standing lamp, diffused light, rotational moulded, white polyethylene material. For LED light source, white colour or RGB. Complete of dimmable driver and orange cable 3 mt with plug IP44 for outdoor.

Lampadaire à lumière diffuse en polyéthylène, moulé par rotation. Avec 3 mètres de câble. Pour source de lumière à LED en couleur blanc ou RGB. Complet avec alimentations dimmables et avec 3 mt de câble et prise IP44 pour outdoor.

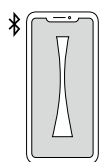

Grazie alla tecnologia Tunable White Led (bianco dinamico), la lampada Biconica, è in grado di riprodurre l'andamento della luce naturale modulando la temperatura di colore dei Led. A seconda delle esigenze o delle necessità, l'utente può modificare a piacere la tonalità del bianco attraverso l'applicazione CASAMBI, permettendo di regolalarla da 2400K a 6500K

Thanks to the Tunable White Led (dynamic white) technology, the Biconica lamp is able reproduce the natural light pattern by modulating the color temperature of the LEDs. Based on demands or needs, the user can modify the tone of white as they wish through the CASAMBI application that allows adjusting the color from 2400K to 6500K

Avec la technologie Tunable White Led (lumière blanche variable), la lampe Biconica est capable de reproduire la dynamique de la lumière naturelle grâce à la possibilité de moduler la température de couleur des LED. Selon les besoins ou nécessités, l'utilisateur peut à son gré modifier la teinte du blanc à travers l'application CASAMBI, ce qui permet de régler la lumière blanche de 2400K à 6500K



PISTILLO



EMILIANA MARTINELLI 2009-2015



2064/P

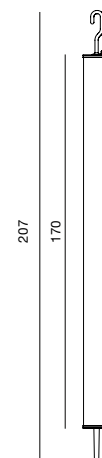

2064/P/XS

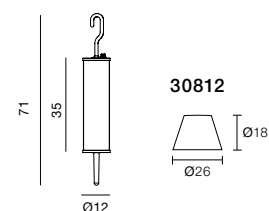

2064/P Ø 12 H171
2x35W G5 T5 FL
40W LED 3000K

2064/P/XS Ø 12 H36
1x12W E27 LED 

30812/NE Ø 26 H 18

Riflettore in alluminio nero
Black aluminium screen
Écran en aluminium noir

 **NE** nero
black
noir

Apparecchio a sospensione per esterno a luce diffusa, formato da un tubo in metacrilato antiurto opal bianco, con particolari supporti di chiusura e di aggancio stampati in resina nel colore nero. Completo di alimentatori elettronici e cavo arancio, 5 metri con spina IP44. Disponibili in tre dimensioni.

Hanging lamp for outdoor, diffused light consisting of a tube in white opal methacrylate antishock, closing and details are in black moulded resin. Complete with electronic ballast and orange cable 5 mt with plug IP44. Available in 3 sizes.

Suspension pour extérieur, à lumière diffuse. Structure en méthacrylate opale blanc, support et détails en résine noir. Alimentateur électronique compris, et câble, 5 mt avec fiche IP44. Disponible en 3 dimensions.

IP65

2294/L
2294/L/1

2294

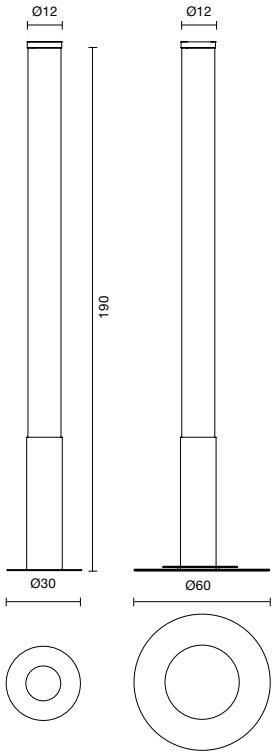

2294/L/DIM
12W LED RGB 1000lm 
2294/L/1/DIM
60W LED 4700lm 3000K 
30870
Base Ø 60



Pistillo con supporto e base in acciaio da fissare a terra di Ø 30 cm o con base da appoggiare di Ø 60 cm, con cavo arancio e spina. Per sorgente di luce a LED bianco o RGB, completo di alimentatore elettronico dimmerabile.

Pistillo with metal support and base in stainless steel of Ø 30 cm to fix to the ground or with base Ø 60 cm to lay on the ground, with orange cable and plug. For LED light source, complete of electronic dimmable driver.

Pistillo avec support et base en acier à fixer par terre de Ø 30 cm ou avec une base à poser de Ø 60 cm, avec un câble orange et une fiche. Pour des sources de lumière à LED blanc ou RGB, équipé d'un alimentateur électrique dimmerable.

IP65

CYBORG

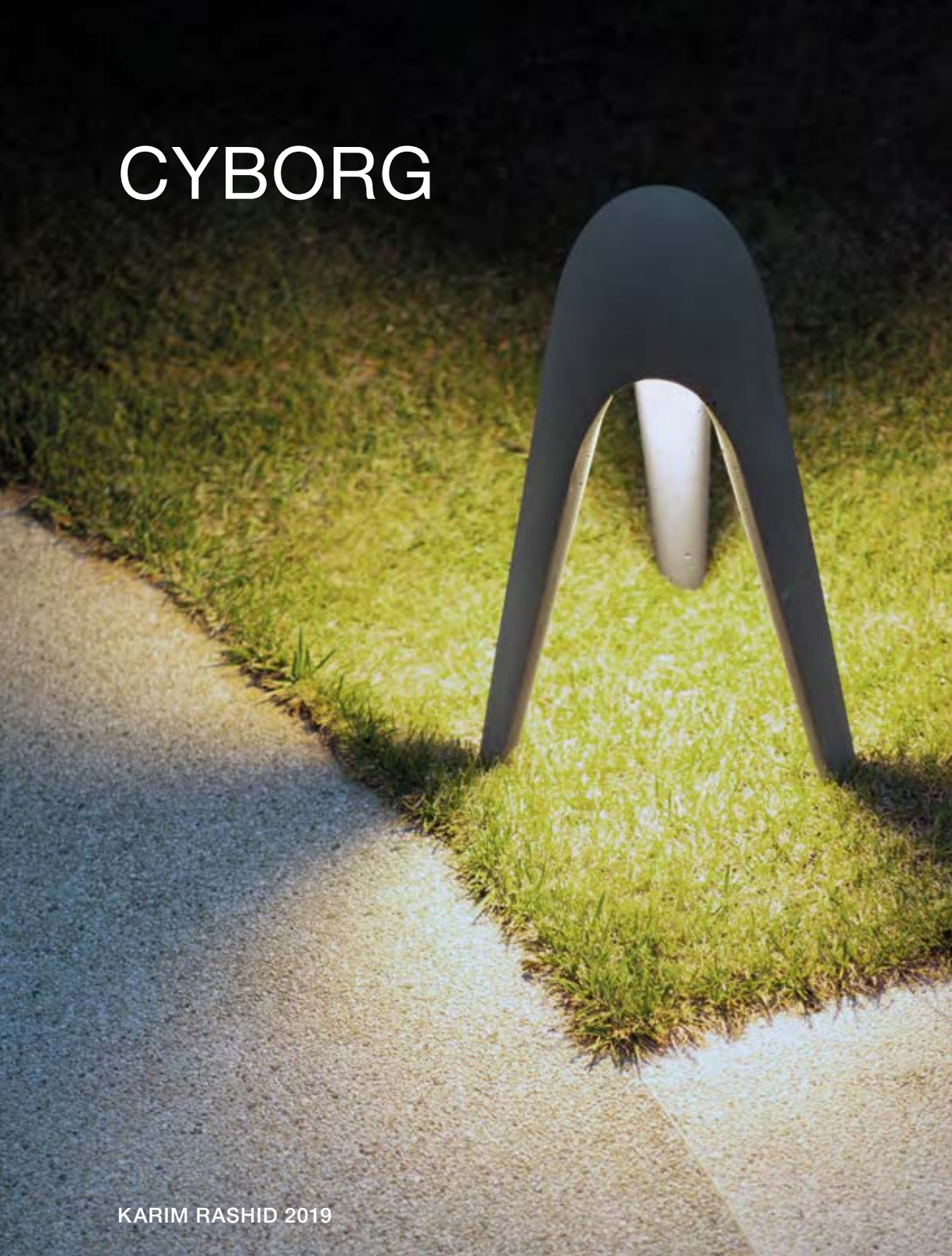



KARIM RASHID 2019



Lampada da esterno da appoggio con cavo elettrico e spina IP44 o da fissare a terra con picchetti. Struttura in cemento ad alta resistenza con idrorepellente nel colore grigio cemento o giallo ocra. Per sorgente di luce a LED.

Outdoor lamp to be placed on the ground with electric cable and plug IP44 or it can be fixed to the ground using pickets. Structure in high-resistance concrete with water-proofer. Comes in concrete-gray or yellow-ochre color. For LED light source.

Lampe de sol d'extérieur avec un câble électrique et une prise IP44 ou à fixer au sol avec des piquets. Structure en ciment de haute résistance imperméabilisée, couleur gris ciment ou jaune ocra. Pour une source de lumière à LED.

2306/GR Ø40 H 61 
10W 230V 1000lm
2700K A++

2306/GI Ø40 H 61 
10W 230V 1000lm
2700K A++

 **GR** grigio / gray / gris
 **GI** giallo / yellow / jaune

IP65

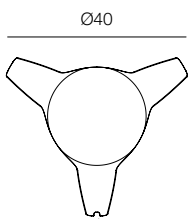
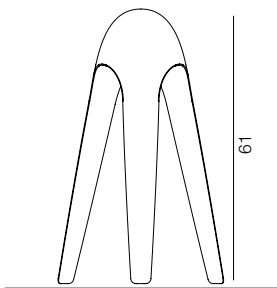

Picchetti per il fissaggio a terra su richiesta
Pickets to fix to the ground on request
Piquets pour la fixation au sol sur demande
40111









PONT



MARC SADLER 2019

PONT



Una lampada da esterno, a luce diretta, per illuminare il tuo spazio verde. Da fissare a terra con basette in acciaio inox in dotazione, o da fissare al terreno con picchetti. Struttura in cemento ad alta resistenza con idrorepellente nel colore grigio cemento, altri colori su richiesta. Per sorgente di luce a LED, alimentatore remoto.

A direct-light outdoor lamp to light your green spaces. To be fixed to the floor with stainless steel base elements (provided), or to the ground with pickets). Structure in high-resistance concrete with water-proofer in concrete-gray color, other colors on request. For LED light source, remote driver.

Lampe d'extérieur, à lumière directe, pour éclairer votre espace vert. À fixer au sol avec des pattes en acier inox qui sont fournies ou à fixer au sol avec des piquets. Structure en ciment de haute résistance, avec un imperméabilisant dans une couleur gris ciment. D'autres couleurs sur demande. Pour une source de lumière à LED, driver à distance.

40105/GR L 114 H 30
24W 24V 1620lm 
2700K A++

40106
alimentatore
driver
alimentateur
30W IP67

40107
alimentatore
driver
150W IP67

40108
scatola con alimentatore
box with driver
boîte avec driver
30W IP67

40109
scatola con alimentatore
box with driver
boîte avec driver
150W IP67

 **GR** grigio
gris



40110
picchetti per il fissaggio a terra
da bloccare all'estremità della lampada
(optional)
pickets to fix to the ground
pickets to be fixed at the extremity of the lamp
(optional)
piquets pour la fixation au sol bloquant l'ex-
trémité de la lampe (en option)

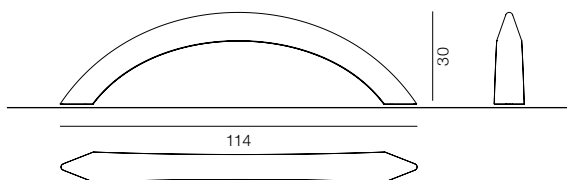

BOLETO

EMILIANA MARTINELLI 2019

Lampada da esterno a luce diretta per sorgente di luce a LED. Struttura in alluminio verniciato nel colore corten. Stelo in due altezze con base per il fissaggio a terra. Alimentatore remoto.

Outdoor lamp direct light for LED light source. Corten painted aluminium structure. Two size tige with base for to fix on the ground. Remote driver.

Lampe de sol à lumière directe pour une source de lumière à LED. Structure en aluminium peint couleur corten. Deux hauteurs de tige sont proposées avec une base pour la fixation au sol. Driver à distance.

2308/CO Ø14 H 50
5W 670lm 2700K A++

LED

2308/J/CO Ø14 H 35
5W 670lm 2700K A++

LED

● CO corten
corten
corten

IP65

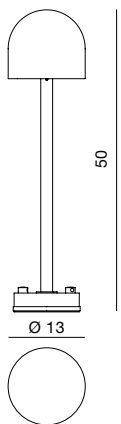
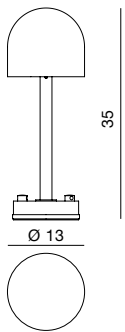

BRUCO



STUDIO NATURAL 2018

Famiglia di lampade da esterno a luce diretta in pressofusione di alluminio verniciato nel colore antracite o corten, con base da fissare a terra. La lampada è componibile con gli elementi a lato (A,B,C,D,E), e da 1 a max 4 corpi lampada. Sorgente di luce LED integrata 230V. Ogni corpo lampada (A) può essere fissato al palo (E) con composizione unidirezionale o con 4 possibili posizioni a 90°.

Family outdoor lamps, diffused light, componibile in die-cast aluminum painted in anthracite or corten color with base to be fixed to the ground. Composed of many elements (A,B,C,D,E) with 1 or max 4 lamps bodies. Aluminium die casting. With pole to be fixed on the floor. Integrated LED light source 230V. Every body lamp (A) can be fixed on the pole (E) with only one direction light or with 4 positions 90°.

Famille de lampes pour l'extérieur, à lumière diffuse, fabriquée par moulage d'aluminium sous pression, peint dans les couleurs anthracite ou corten, avec un base à fixer au sol. L'appareil se compose avec les éléments indiqués sur le côté (A,B,C,D,E) et de 1 à max. 4 corps de lampes. Source de lumière à LED intégrée 230V. Chaque élément d'éclairage (A) peut être fixé sur le poteau (E) pour une lumière unidirectionnelle ou dans 4 positions différentes à 90°.

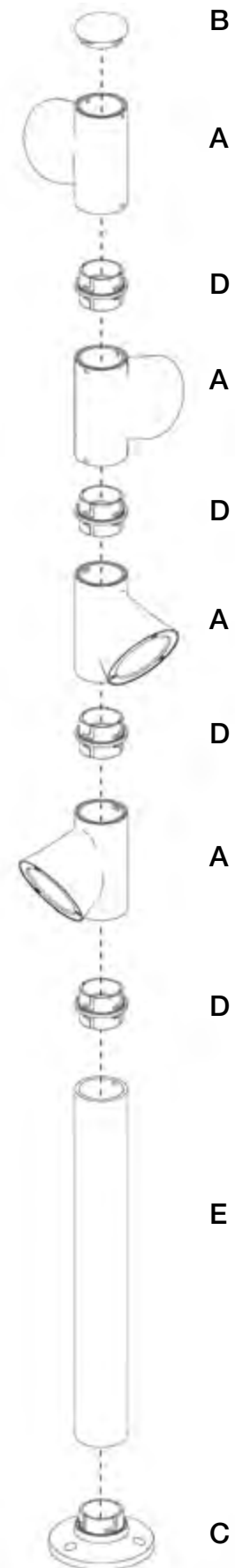

IP65

lampada modulare da fissare a terra.
 Modular lamp to be fixed on the ground.
 Lampe modulaire à fixer au sol.

12W 230V LED 2700K A++ 

testa / head / tête

40059/AN Ø 6,5 H 13,5 →14

40059/CO Ø 6,5 H 13,5 →14

tappo / top / embout

40060/AN Ø 6,5 H 1

40060/CO Ø 6,5 H 1

base

40061/AN Ø 13 H 3

40061/CO Ø 13 H 3

giunto / joint

40062/AN Ø 6,5 H 5

40062/CO Ø 6,5 H 5

palo / pole / poteau

40063/AN Ø 6,5 H 33

40063/CO Ø 6,5 H 33

40064/AN Ø 6,5 H 47

40064/CO Ø 6,5 H 47

 **AN** antracite
 anthracite
 anthracite

 **CO** corten
 corten
 corten

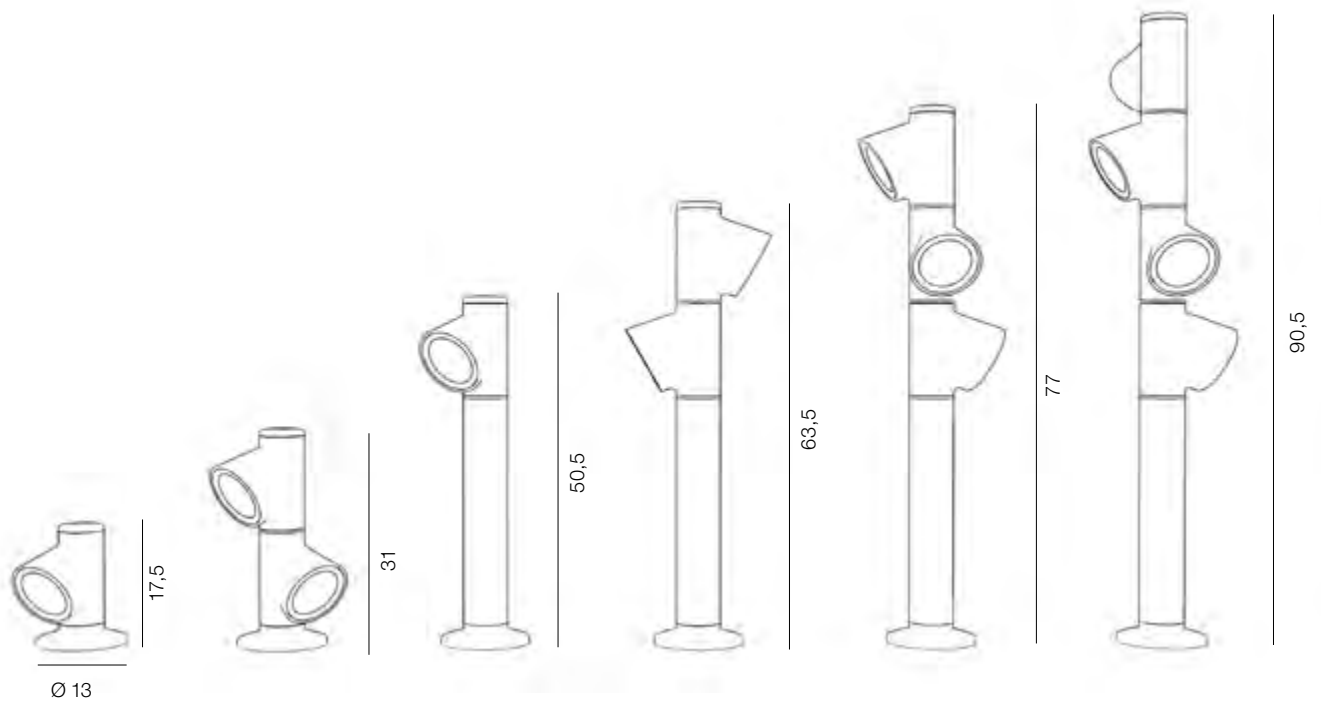





BRUCO PARETE





Lampada da parete per outdoor, della famiglia Bruco a luce diretta orientabile. Formata da uno o da due corpi lampada in fusione di alluminio verniciato nei colori antracite o corten. Per sorgente di luce a Led.

Outdoor wall lamp for the Bruco family, swivel direct light. Formed by one or two lamp bodies in aluminium die casting painted anthracite or corten color. For Led light source.

Applique murale de la famille de produits Bruco. Formée d'un ou de deux corps de lampe, Structure obtenue par moulage sous pression d'aluminium, teinte de finition brun rouille ou gris anthracite. Avec source lumineuse à Led.

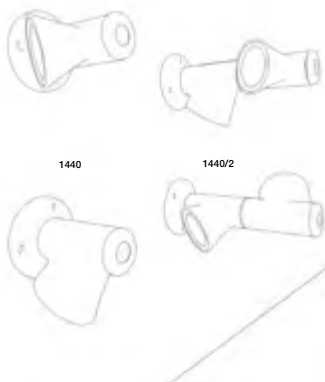
IP65





1x12W LED 2700K 

1440/AN Ø 6,5 H 14 →17,5

1440/CO Ø 6,5 H 14 →17,5

 **AN** antracite
anthracite
anthracite

 **CO** corten
corten
corten

2x12W LED 2700K 

1440/2/AN Ø 6,5 H 31,5 →38

1440/2/CO Ø 6,5 H 31,5 →38



KOALA



EMILIANA MARTINELLI 2019

Una lampada da parete per esterno a luce diretta/indiretta. Struttura in cemento ad alta resistenza con idrorepellente, nel colore grigio cemento. Per sorgente di luce a LED, alimentatore integrato.

A wall lamp for outdoor direct/indirect light. Grey concrete structure in high-resistance with water-proofer. For LED light source, integrated driver.

Applique pour l'extérieur à lumière directe/indirecte. Structure en ciment de haute résistance, imperméabilisée, couleur gris ciment. Pour une source de lumière à LED, driver intégré.

1444/GR L 18 → 14 H 18
2x10W 2x1000lm 2700K A++

● GR grigio / gray / gris

LED

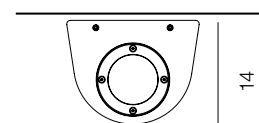
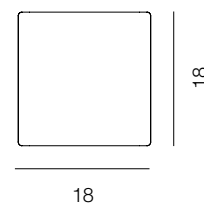

IP65



PLAN



MARC SADLER 2019

Una lampada da parete per esterno a luce indiretta. Struttura in cemento ad alta resistenza con idrorepellente, nel colore grigio. Per sorgente di luce a LED.

An outdoor wall lamp for indirect light. Gray concrete structure in high-resistance with water-proofer. For LED light source.

Applique pour l'extérieur à lumière indirecte. Structure en ciment à haute résistance, imperméabilisée, couleur gris. Pour une source de lumière à LED.

1443/P/GR L 40 → 20 H 7
13W 1500lm 230V 3000K A++ 

 **GR** grigio / gray / gris

IP65

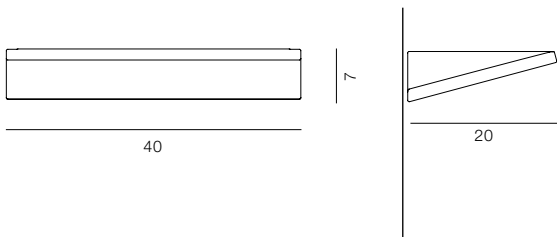

OUT

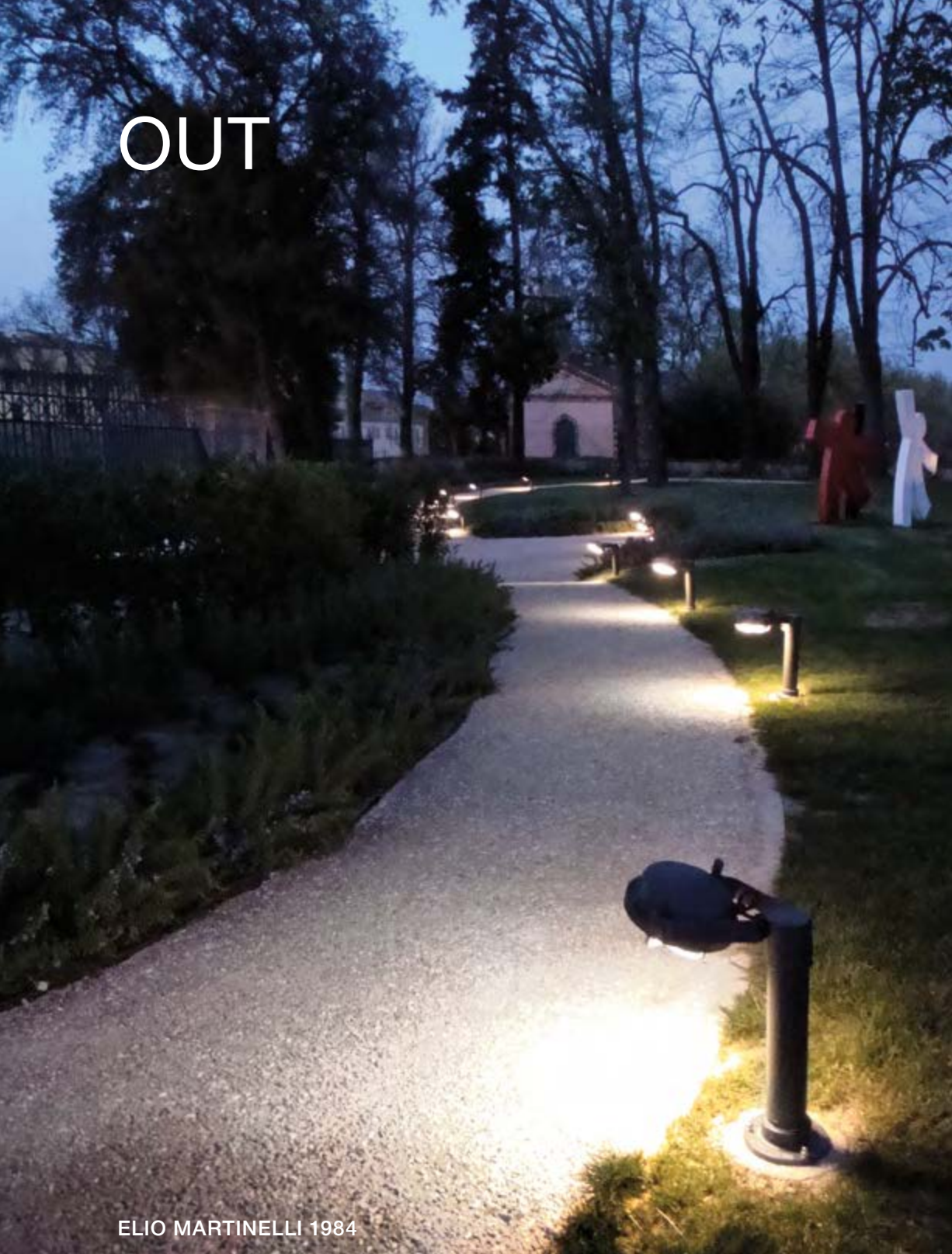

ELIO MARTINELLI 1984

Una famiglia di lampade da esterno a luce diffusa, da terra con palo in vetroresina, da parete e soffitto. Per lampada a LED Corpo in resina rinforzata con fibre di vetro. Finitura con vernici poliuretaniche, nei colori bianco, antracite e corten. Griglia in acciaio verniciato. Diffusore in policarbonato.

A family lamps for outdoor with diffused light floor lamp with a rod made of fiberglass, wall lamp, swinging lamp. For LED bulb. The body is made of resin reinforced with glass fibres. Finishing with polyurethane paints, in white, anthracite and corten. Grid made of paint steel. Diffuser made of polycarbonate.

Une famille de lampes pour l'extérieur avec lumière diffusée, lampadaire avec une tige réalisée en fibre de verre, applique, ou plafond. Pour lampe à LED. Corps en résine renforcée avec fibres de verre. Finition avec peintures de polyuréthanes, en blanc, anthracite et corten. Grille en acier. Diffuseur en polycarbonate.

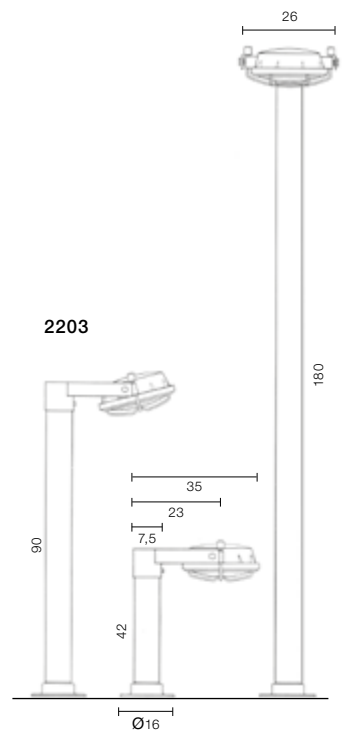

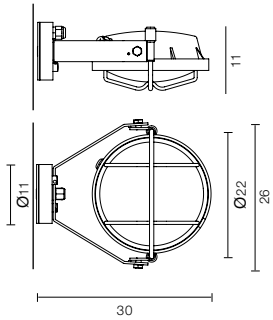

1245

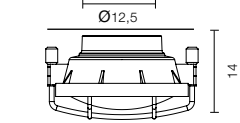

2813



1245/BI/AN/CO Ø26 H11→30
1x8W LED 1100lm 3000K IP54



2203/180/BI/AN/CO Ø22 H180
1x8W LED 1100lm 3000K IP65



2203/90/BI/AN/CO Ø22 H90
1x8W LED 1100lm 3000K IP65



2203/42/BI/AN/CO Ø22 H42
1x8W LED 1100lm 3000K IP65



2813/BI/AN/CO Ø26 H11
1x8W LED 1100lm 3000K IP54



○ **BI** bianco / withe / blanc

● **AN** antracite / anthracite / anthracite

● **CO** corten / corten / corten







POLO



ELIO MARTINELLI 1986

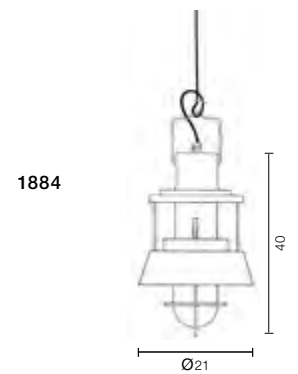
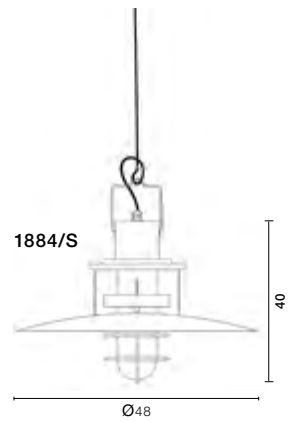

Una famiglia di lampade da esterno a luce diffusa ,da terra con palo in vetroresina, da parete, da soffitto e a sospensione. Per lampada a LED. Corpo in resina rinforzata con fibre di vetro. Finitura con vernici poliuretatiche, nei colori bianco, antracite e corten. Griglia in acciaio. Diffusore in vetro satinato.

A family lamps for outdoor with diffused light, floor lamp with a rod made of fiberglass, wall lamp, and hanging lamp. For LED bulb. The body is made of resin reinforced with glass fibres. Finishing with polyurethane paints, in white, anthracite. Grid made of steel. Diffuser made of glazed glass.

Une famille de lampes pour l'extérieur à lumière diffuse, au sol avec poteau en fibre de verre, mural, plafond et suspension. Structure en resine renforcée avec fibre de verre peint en couleur blanc, anthracite et corten. Grille en acier. Diffuseur interne en verre dépoli.



1884/BI/AN/CO	Ø 40 H50
1x15W E27 LED	IP54 
1884/S/BI/AN/CO	Ø 40 H50
1x15W E27 LED	IP54 

 **BI** bianco / withe / blanc

 **AN** antracite / anthracite / anthracite

 **CO** corten / corten / corten





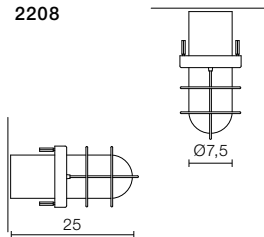

2208



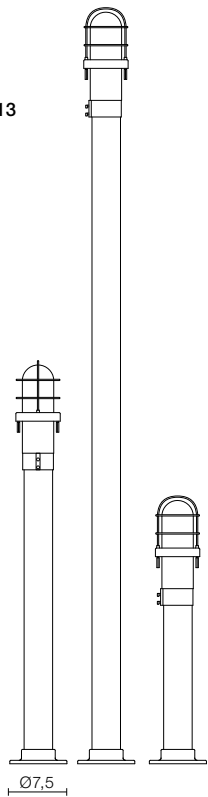

2213



2808/BI/AN/CO
1x15W E27 LED

Ø13 H25
IP54 

-  **BI** bianco / withe / blanc
-  **AN** antracite / anthracite / anthracite
-  **CO** corten / corten / corten

2213/200/BI/AN/CO
1x15W E27 LED

Ø13 H200
IP65 

2213/110/BI/AN/CO
1x15W E27 LED

Ø13 H200
IP65 

2213/63/BI/AN/CO
1x15W E27 LED

Ø13 H200
IP65 



2250

ELIO MARTINELLI 1986

Lampada da esterno a luce diffusa e riflessa, riflettore in alluminio, diffusore in vetro pirex satinato, guarnizioni in silicone. Corpo completo di gruppo di alimentazione, palo cilindrico in acciaio zincato verniciato nel colore antracite. Verniciatura a polvere nel colore grigio scuro. Per sorgente di luce a LED.

Standing outdoor lamp, reflected and diffused light, painted aluminium reflector in anthracite color, pyrex glass diffuser, silicon rubber seal. Complete of wiring parts, pole cylinder in galvanized steel, painted in anthracite colour. For LED light source.

Lampe pour outdoor, avec lumière diffusée et réfléchié, réflecteur en aluminium, diffuseur en verre pirex dépoli, garnitures en silicones. Corps équipé d'un groupe d'alimentation, tige cylindrique en acier galvanisé. Peinture à poudre en anthracite couleur. Pour source de lumière LED.



2250/L/1 Ø60 H 350

39W LED 4200lm 3000K 

 **AN** antracite
anthracite
anthracite

IP54



CREDITI

ART DIRECTION & EDITING

EMILIANA MARTINELLI

PHOTOGRAPHY

EMILIANA MARTINELLI
MARCO CARDELLI
BENVENUTO SABA
MARCO GHILARDUCCI
MARCO DEL GRECO
MASSIMILIANO BOLCIONI
STEFANO ANZINI

PRINTING

GRAFICHE MARTINELLI - FIRENZE

EDITION

GENNAIO 2020 © ALL RIGHTS RESERVED

THANKS FOR LOCATION TO:

MICHEL BOUCQUILLON E
DONIA MAAOUI BOUCQUILLON - LUCCA
IL PALAZZACCIO - LUCCA
FIORELLA PARENTI - CAMAIORE
ALFONSO FEMIA - BIENNALE D'ARCHITETTURA
LE CLUB - MAISON & OBJECT - PARIGI
IL DIAVOLETTA SAN GENNARO - LUCCA
LO CHALET - TORRE DEL LAGO
MACDONALD - PARIGI
VILLA BERNARDINI - LUCCA
CONVENTO S.AGOSTINO - LUCCA
CIBART - SERAVEZZA
ANFITEATRO - LUCCA
SEDE MARTINELLI LUCE - LUCCA
POGGIO TERRALBA - PISA

martinelli luce spa

si riserva il diritto di apportare ai propri modelli in ogni momento senza nessun preavviso, qualsiasi modifica ritenesse opportuna.

Reserves the right to introduce any changes to its own models, without prior notice.

Nous nous réservons la faculté de modifier à tout moment et sans préavis les caractéristiques des appareils illustrés dans ce catalogue.

martinelli luce spa

via Teresa Bandettini
55100 Lucca - Italy
+39 0583 418315
www.martinelliluce.it
info@martinelliluce.it

showroom martinelli luce
via S. Lucia 9, 55100 Lucca
+ 39 0583 496254
showroom@martinelliluce.it



martinelli luce spa +39 0583 418315 www.martinelliluce.it info@martinelliluce.it

