

**Open  
your doors  
to glass  
solutions.**

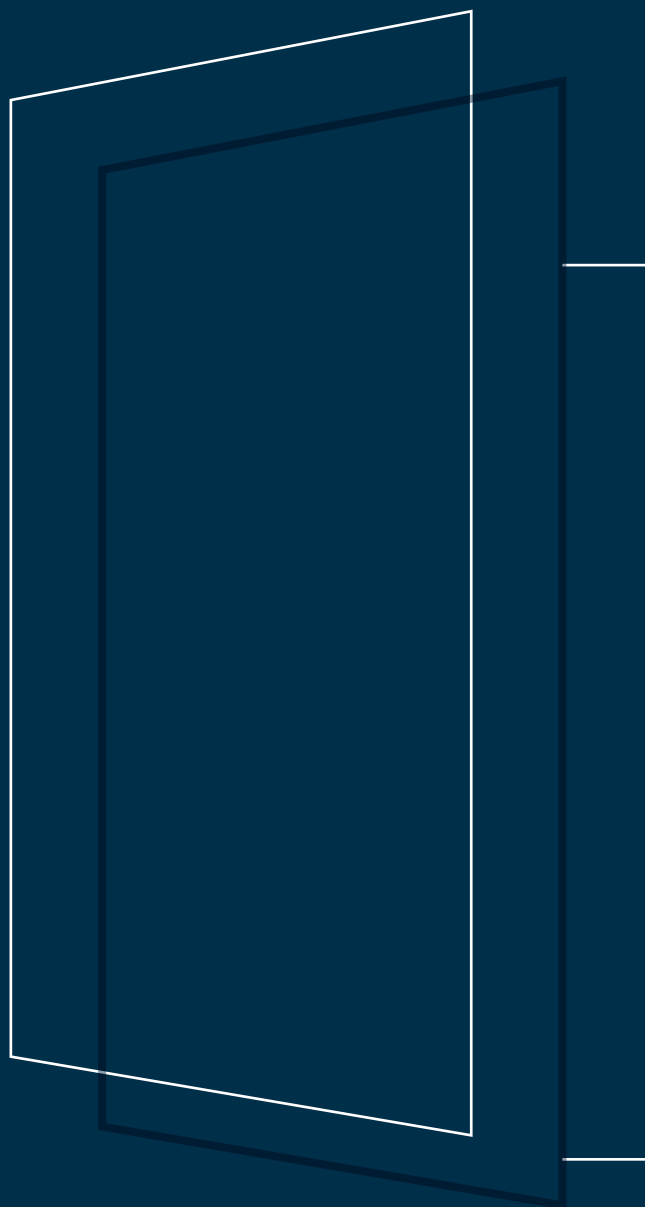

**BLUINTERNI®**  
ITALIAN ARCHITECTURAL DOORS

**Le porte  
si aprono  
alla versatilità  
del vetro.**

**Doors open  
themselves  
to the versatility  
of the glass.**

Il design made in Italy e la progettualità di Bluinterni si riflettono in una collezione di sistemi di apertura e chiusura da interno, che apre il dialogo tra gli ambienti attraverso l'eleganza e la leggerezza materica del vetro.

## Soluzioni in vetro, per porte di design.

**Solutions in glass, for design doors.** Made in Italy design and the availability of project that distinguish Bluinterni reflect themselves to a fully collection of opening and closing for interior. This collection opens the dialogue between spaces, through elegance and light of the glass.

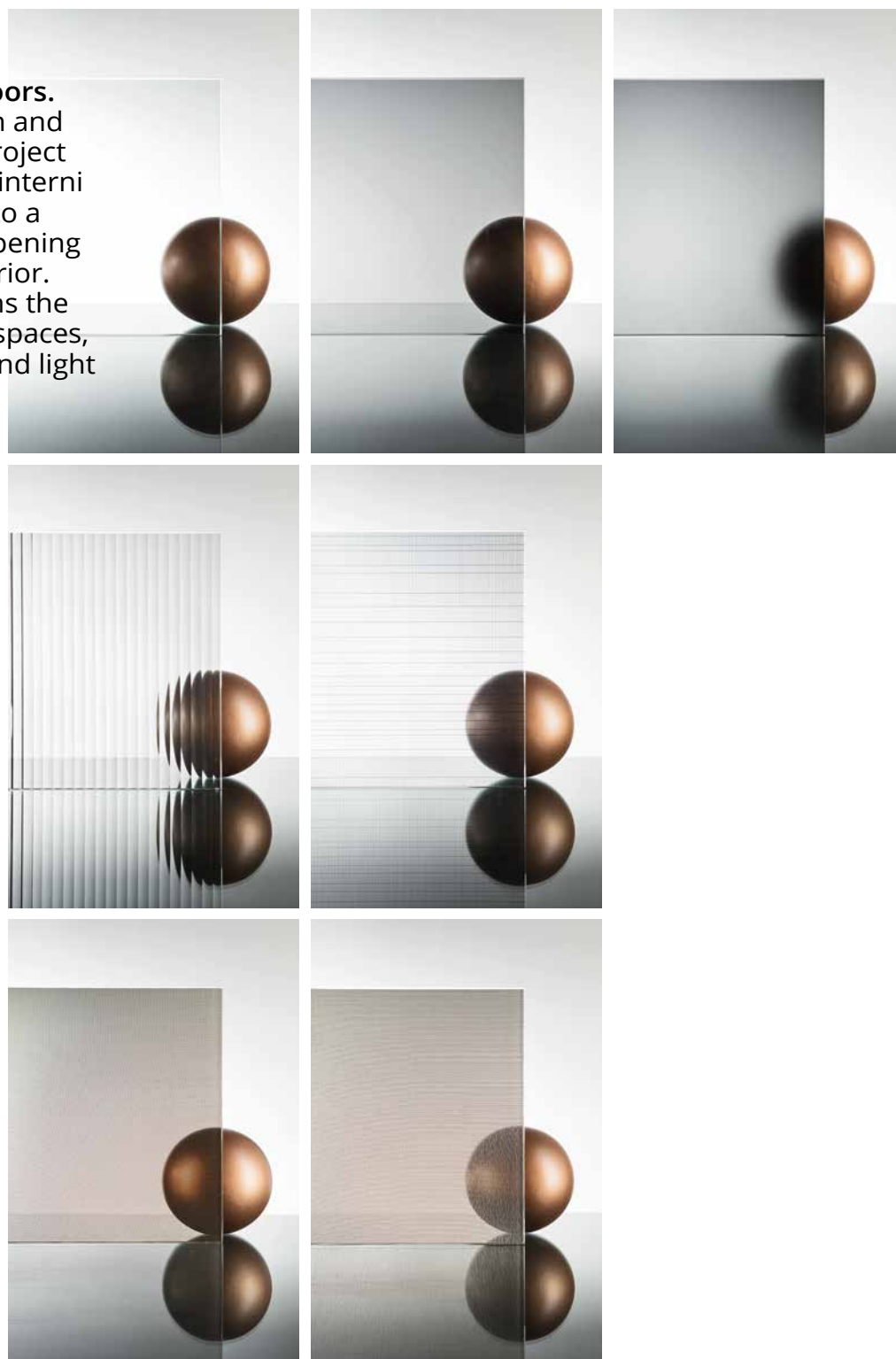

## Ante vetro

Glass doors

### Quadro-Line

apertura - openings

**Battente** > 007  
swing door

**Bilico** > 017  
pivot door

### Quadro-Frame

apertura - openings

**Battente** > 015  
swing door

### Vitrum-Line

apertura - openings

**Battente** > 075  
swing door

**Box** > 081

**Bilico** > 083  
pivot door

### Quadro-Move

scorrevole - sliding doors

sistema di scorrimento  
sliding system

**Sky** > 027

**Luce-S** > 039

**Luce-B** > 039

**Basic** > 051

**Minima** > 063

### Vitrum-Move

scorrevole - sliding doors

sistema di scorrimento  
sliding system

**Sky** > 086

**Luce** > 091

**Basic** > 095

**Minima** > 099

**Multy 80** > 103

**Multy 81** > 105

**Magic** > 107

### Specifiche tecniche

technical specification

> 109

### Finiture

Finishes

> 127

**Un sottile profilo  
in alluminio,  
in diverse finiture,  
incornicia  
e impreziosisce  
le soluzioni di  
apertura dell'anta  
in vetro.**

A thin aluminium profile, in different  
finishings, frame and increase value to glass  
doors opening solution.



**Quadro-Line**  
**Quadro-Frame**  
**Quadro-Move**

**Battente**  
swing door

**Bilico**  
pivot door

**Scorrevole**  
sliding door

---

## Quadro-Line **Battente** | Swing system

APERTURA battente  
PORTA spingere/tirare con telaio  
ALTEZZA da 2000 a 2700 mm

—  
OPENING swing  
DOOR push/pull with frame  
HEIGHT from 2000 to 2700 mm





Quadro-Line  
L 800 x H 2400 mm  
LM34 Telaio Bronzo - VT04 Vetro Luxor  
LM34 Bronze Frame - VT04 Luxor Glass

Quadro-Line

**L 800 x H 2700 mm**

LM36 Telaio Grafite con inserti -

VG02 Vetro Grigio Satinato

LM36 Graphite Frame with inserts -

VG02 Satin Smoked Glass



**Serratura con maniglia Q-120WC finitura Nichel**  
Lock with handle Q-120WC Nickel finishing



**Apertura battente con cerniere a scomparsa**  
Swing opening with hidden hinges

Quadro-Line  
**L 800 x H 2700 mm**  
LM33 Telaio Nichel -  
VV01 Vetro Extrachiario Trasparente  
LM33 Nickel Frame -  
VV01 Transparent Extraclear Glass





## Quadro - Frame Battente | Swing system

Le linee squadrate del telaio seguono e catturano i profili della porta incorniciandola. Come un quadro decora la parete e apre lo sguardo verso nuovi spazi. Al suo interno il vetro è racchiuso in un sottile profilo tono su tono che esalta tutta la sua bellezza con un effetto satinato. La porta in versione total white è uno stile intramontabile, una soluzione perfetta per arredare con raffinatezza ambienti dal gusto più classico e rendere leggeri e luminosi quelli più moderni.

**Neutral tones for sophisticated spaces.**  
Square lines of the frame follow and capture door profiles, in order to frame it. As a picture it decorates the wall and gives a look to new spaces. Inside, the glass is framed on a small profile tone on tone that shows its beauty with a satin effect. The "total white" door is a timeless style, it is a perfect solution to decorate with distinction classic style spaces and make lighter and the modern spaces.

**Toni  
neutri per  
ambienti  
raffinati.**



Quadro-Frame  
L 800 x H 2400 mm  
LO01 Telaio e Stipite Bianco -  
VV02 Vetro Extrachiaro Satinato  
LO01 White Frame and Jamb -  
VV02 Satin Extraclear Glass

## Quadro-Line **Bilico** | Pivot door

APERTURA bilico  
PORTA con telaio  
ALTEZZA fino a 2700 mm

—  
OPENING bilico pivot  
DOOR with frame  
HEIGHT up to 2700 mm



Quadro-Line BILICO  
**L 1250 x H 2500 mm**

LM34 Telaio Bronzo con inserti -  
VB01 Vetro Bronzo Trasparente  
LM34 Bronze Frame with inserts -  
VB01 Transparent Bronze Glass

Gli ambienti della casa dialogano tra loro attraverso le porte, veri e propri complementi d'arredo la cui estetica e funzionalità conferiscono carattere agli spazi. La bellezza della trasparenza del vetro ruota su sé stessa e si nasconde con delicatezza dietro un leggero effetto decorativo che come un filo crea una trama. Un dettaglio che esalta e impreziosisce la superficie della porta. Un sistema che apre e chiude gli spazi con un gusto ricercato ideale per grandi aperture.

**The beauty of the glass for big and elegant openings.** Home spaces talk through doors, furnishing elements with aesthetics and functionality. The beauty of the glass transparency rotates and hides behind a light decorative effect that creates a net. A detail that enhances and gives value to the door surface. A system that opens and closes the spaces with a valued taste ideal and adapted for big openings.

## La bellezza del vetro per grandi ed eleganti aperture.



Quadro-Line BILICO  
**L 1000 x H 2700 mm**  
 LM33 Telaio Nichel - VS01 Vetro Cyber  
 LM33 Nickel Frame - VS01 Cyber Glass



**Chiusure invisibili con i meccanismi a scomparsa.**

**Invisible closing with hidden mechanism.**

Quadro-Line BILICO  
con pannelli laterali fissi | with fix lateral panels

**L 950 x H 2700 mm**

LM36 Telaio Grafite -

VV01 Vetro Extrachiario Trasparente

LM36 Graphite Frame -

VV01 Transparent Extraclear Glass



**Cerniera apertura a bilico con stipite**  
Pivot hinge opening with jamb



**Serratura con maniglia Q-120WC finitura Grafite**  
Lock with handle Q-120WC Graphite finishing

Quadro-Line BILICO  
**L 1000 x H 2700 mm**  
LM36 Telaio e Stipite Grafite -  
VV01 Vetro Extrachiaro Trasparente  
LM36 Graphite Frame and Jamb -  
VV01 Transparent Extraclear Glass

## Quadro-Move **Scorrevole** | Sliding system

### **SKY**

Sistema di scorrimento - Sliding system

**APERTURA** scorrevole  
**PORTA** con telaio singola/doppia  
e binario incassato  
**ALTEZZA** da 2000 a 2700 mm

—  
**OPENING** sliding  
**DOOR** with frame single/double  
and built-in rail  
**HEIGHT** from 2000 to 2700 mm



Quadro-Move SKY  
**L 900 + 900 x H 2700 mm**  
FO01 Telaio Frassino Oliva -  
VT04 Vetro Luxor  
FO01 Olive Ash Frame -  
VT04 Luxor Glass





Le maniglie delle porte sono accessori funzionali ma anche dettagli di stile: espresse attraverso un design ergonomico accompagnano con facilità lo scorrimento dei pannelli. Un movimento che divide e unisce in uno stile unico non solo gli ambienti, ma anche materiali e finiture diverse. La modernità del vetro incontra la classicità delle venature della finitura frassino che riveste la praticità delle maniglie e l'eleganza dei profili della porta.

**Style and functionality available.** Door handles are functional accessories but also style details: ergonomic design help the sliding of panels. A movement that divide and match in a single style spaces, materials and finishings. The modernity of the glass encounter the classic effect of ash vein, that covers handle and the elegance of door profile.

**Stile e funzionalità  
a portata di mano.**



**Maniglia D-30 finitura Frassino Oliva**  
Handle D-30 Olive Ash finishing

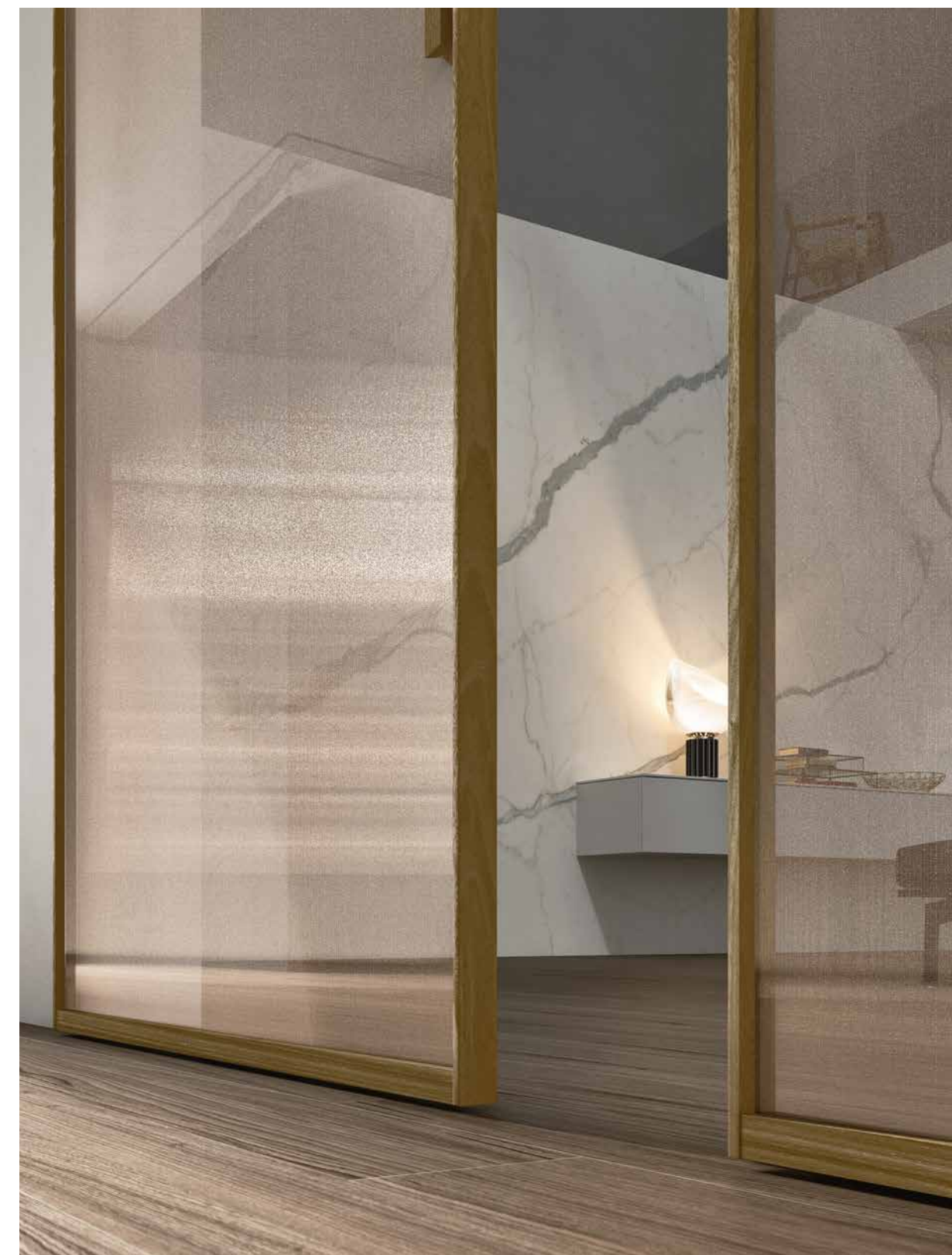

**Sistema di scorrimento Sky con telaio Frassino Oliva**  
Sky sliding system with Olive Ash frame



**Particolare binario incassato a soffitto**  
Detail of built-in rail



**Maniglia L-50 finitura Bianco**  
Handle L-50 White finishing

Quadro-Move SKY  
**L 800 x H 2700 mm**  
LO01 Telaio Bianco -  
VV02 Vetro Extrachiario Satinato  
LO01 White Frame -  
VV02 Satin Extraclear Glass

Sky, porte con  
ante scorrevoli  
a trascinamento.

Sky,  
sliding doors  
with dragging.

Quadro-Move SKY  
con trascinamento | with dragging

**L 1200 + 1200 x H 2700 mm**

LM34 Telaio Bronzo -  
VB01 Vetro Bronzo Trasparente

LM34 Bronze Frame -  
VB01 Transparent Bronze Glass

Il sistema di apertura a scorrimento propone anche soluzioni ad una sola anta per aprire e chiudere gli spazi con grande fluidità. Le pareti diventano dinamiche e l'aggiunta di una texture tridimensionale esalta e movimentata ancora di più la leggerezza del vetro ridisegnando la superficie con un effetto materico "millerighe". Un'espressione di stile che affascina alla vista e al tatto, ma anche una soluzione di grande carattere che trova spazio in ambienti sia classici che moderni.

**3D effects for dynamic glass surfaces.**

Sliding system offers easy opening and closing even to single doors. Walls becomes dynamic and the use of a three-dimensional texture gives movement to the glass light re-designing with a "multi-lines" effect. A style expression that attract by touch and by sight, but also a strong personality that finds space in classic and modern areas.

**Effetti  
3D per  
superfici  
in vetro  
dinamiche.**



Quadro-Move SKY  
**L 1100 x H 2700 mm**  
 RS01 Telaio Rovere Scuro -  
 VO06 Vetro Vintage  
 RS01 Dark Oak Frame -  
 VO06 Vintage Glass



## Quadro - Move **Scorrevole** | Sliding system

### **LUCE-S / LUCE-B**

Sistema di scorrimento - Sliding system

**APERTURA** scorrevole

**PORTA LUCE-S** con telaio singola/doppia e binario incassato

**PORTA LUCE-B** con telaio singola/doppia e velette

**ALTEZZA** da 2000 a 2700 mm

**OPENING** sliding

**LUCE-S DOOR** with frame single/double and built-in rail

**LUCE-B DOOR** with single/double frame and cover profile

**HEIGHT** from 2000 to 2700 mm



Quadro-Move LUCE-S  
**L 1100 + 1100 x H 2700 mm**  
NC01 Telaio Noce Canaletto -  
VB02 Vetro Bronzo Satinato  
NC01 American Walnut Frame -  
VB02 Satin Bronze Glass

Vetro e legno, un incontro tra leggerezza e resistenza, proposto in una soluzione a scorrimento ideale per dividere tra loro ambienti diversi, ma anche per separare zone diverse all'interno dello stesso ambiente. Come la possibilità di creare uno spazio benessere all'interno della stanza da bagno o uno spazio guardaroba all'interno della camera da letto. Optare per vetri con effetti cromatici e soluzioni decorative garantisce il comfort della privacy. La funzionalità non rinuncia allo stile.

**Light solution to create space inside spaces.**

Glass and wood, a fusion of light and resistance, proposed in an ideal sliding solution adapt to divide different spaces, but to separate different areas on the same room as well. As the possibility to create a wellness area on the bathroom or dressing room inside the bedroom. Chosing coloured effects or decorated glasses grants comfort privacy. Functionality doesn't forget the style.

**Soluzioni leggere per creare spazi negli spazi.**



**Sistema di scorrimento Luce-S con telaio Noce Canaletto**  
Luce-S sliding system with American Walnut frame

Quadro-Move LUCE-B  
**L 950 x H 2500 mm**  
+ 2 laterali fissi | + 2 laterali fixed  
LM34 Telaio Bronzo -  
VS01 Vetro Cyber  
LM34 Bronze Frame -  
VS01 Cyber Glass







**Sistema di scorrimento Luce-S**  
Luce-S sliding system



**Sistema di scorrimento Luce-B**  
Luce-B sliding system

Quadro-Move LUCE-S  
**L 750 + 750 x H 2700 mm**  
+ 2 laterali fissi | + 2 laterali fixed  
LO12 Telaio Nero -  
VG01 Vetro Grigio Trasparente  
LO12 Black Frame -  
VG01 Transparent Smoked Glass



Profili neri dalle linee minimal e vetro in finitura grigio fumé: un abbinamento che dà forma a una soluzione ideale per arredare contesti domestici, ma anche uffici dal carattere moderno e contemporaneo. Nel movimento a scorrimento i pannelli mobili si sovrappongono a quelli fissi, aprendo e chiudendo gli spazi all'occorrenza e diventando parte integrante dell'arredamento. La veletta si inserisce nel sistema a scorrimento come elemento strutturale per completare con eleganza il movimento.

**Coloured effect  
blend the light with elegance.**

Black profiles with small lines and smoked glass: a match that gives the best to houses and modern/contemporary office environments. When moving, sliding panels overlap fixed panels, opening and closing spaces when needed and becoming part of the furnishing. The cover profile as structural element, completes the elegant sliding movement.

**Effetti  
cromatici  
sfumano la  
leggerezza  
con eleganza.**



**Maniglia D-30 finitura Nero**  
Handle D-30 Black finishing

## Quadro-Move **Scorrevole** | Sliding system

### **BASIC**

Sistema di scorrimento - Sliding system

**APERTURA** scorrevole  
**PORTA** con telaio singola/doppia  
e velette  
**ALTEZZA** da 2000 a 2700 mm

**OPENING** sliding  
**DOOR** with frame single/double  
and cover profile  
**HEIGHT** from 2000 to 2700 mm



La decorazione  
scorre attraverso  
il vetro.

The decoration  
flows through  
the glass.

Quadro-Move BASIC  
L 1100 + 1100 x H 2400 mm  
LO20 Telaio Nuvola -  
VO06 Vetro Vintage  
LO20 Cloud Frame -  
VO06 Vintage Glass



Quadro-Move BASIC  
**L 1000 x H 2100 mm**  
LO12 Telaio Nero -  
VV01 Vetro Extrachiario Trasparente  
LO12 Black Frame -  
VV01 Transparent Extraclear Glass



**Sistema di scorrimento Basic**  
Basic sliding system



**Maniglia F-27 finitura Grafite**  
Handle F-27 Graphite finishing



Quadro-Move BASIC  
**L 800 x H 2400 mm**  
LM36 Telaio Grafite -  
VG01 Vetro Grigio Trasparente  
LM36 Graphite Frame -  
VG01 Transparent Smoked Glass

La bellezza  
della  
trasparenza  
illumina gli  
ambienti.

the beauty  
of the  
transparency  
enlight  
spaces

Quadro-Move BASIC  
L 1000 + 1000 x H 2400 mm  
LM33 Telaio Nichel con inserti -  
VV01 Vetro Extrachiario Trasparente  
LM33 Nickel Frame with inserts -  
VV01 Satin Transparent Glass



**Telaio con inserti e maniglia F-27 finitura Nichel**  
Frame with inserts and handle F-27 Nickel finishing

**Geometrie  
raffinate  
esaltano la  
trasparenza.**

La leggerezza del vetro delle ante scorrevoli si impreziosisce con la bellezza di sottili geometrie in finitura nichel, in perfetta armonia con l'estetica minimal di telaio, velette e maniglie. Linee sottili tracciano sulla superficie liscia del vetro il disegno di uno stile dal gusto originale in grado di esaltarne la trasparenza. Una porta che diventa protagonista dell'arredamento di grandi spazi, da ammirare comodamente seduti nel comfort di una zona giorno.

**Sophisticated geometry  
excite the transparency.**  
The light of the glass in sliding panels enhances itself with the beauty of thin nichel geometries, in perfect harmony to the frame, cover profiles and handles. Thin lines draws on the smooth surface the glass, having an original drawing that excites the transparency. The door becomes the main protagonist of big spaces, to admire while relaxing on the living room.



## Quadro-Move **Scorrevole** | Sliding system

### **MINIMA**

Sistema di scorrimento - Sliding system

**APERTURA** scorrevole  
**PORTA** con telaio singola/doppia  
a scomparsa interno muro  
**ALTEZZA** da 2000 a 2700 mm

**OPENING** sliding  
**DOOR** with frame single/double  
sliding inside the wall  
**HEIGHT** from 2000 to 2700 mm



**Minimo  
ingombro per  
una massima  
apertura.**

**Minimum  
volume for  
a maximum  
opening.**

Quadro-Move MINIMA  
**L 900 x H 2400 mm**  
LO01 Telaio Bianco -  
VT02 Vetro Mesh Gold  
LO01 White Frame -  
VT02 Mesh Gold Glass

Uno scorrevole in vetro che evoca esteticamente nella finitura gli intrecci del tessuto propri della trama del lino, infonde nell'ambiente una sensazione di naturale freschezza visiva. Una porta che apre completamente gli spazi tra le stanze comunicanti e lascia libera la parete su cui si inserisce nascondendosi, in un solo movimento, dentro la stessa. Una soluzione salvaspazio che si adatta bene in presenza di stanze di piccole dimensioni, dove la necessità è quella di gestire in modo efficiente lo spazio.

**Save-space opening,  
free from obstructions.**

A sliding glass that reminds esthetically the "linen fabric", gives to the space a natural effect of visual freshness.

A door that completely opens spaces between connecting rooms and leaves the wall free, hiding itself inside the wall in one single movement. A space-saving solution suitable in case of small environments, where the need is to organize the space in the best and most efficient way.

**Aperture  
salvaspazio  
per una  
parete  
libera da  
ingombri.**

Quadro-Move MINIMA  
**L 900 x H 2100 mm**  
LM33 Telaio Nichel -  
VO07 Vetro Lino  
LM33 Nickel Frame -  
VO07 Lino Glass





**Serratura Q-150WC finitura Nichel**  
Lock Q-150WC Nickel finishing

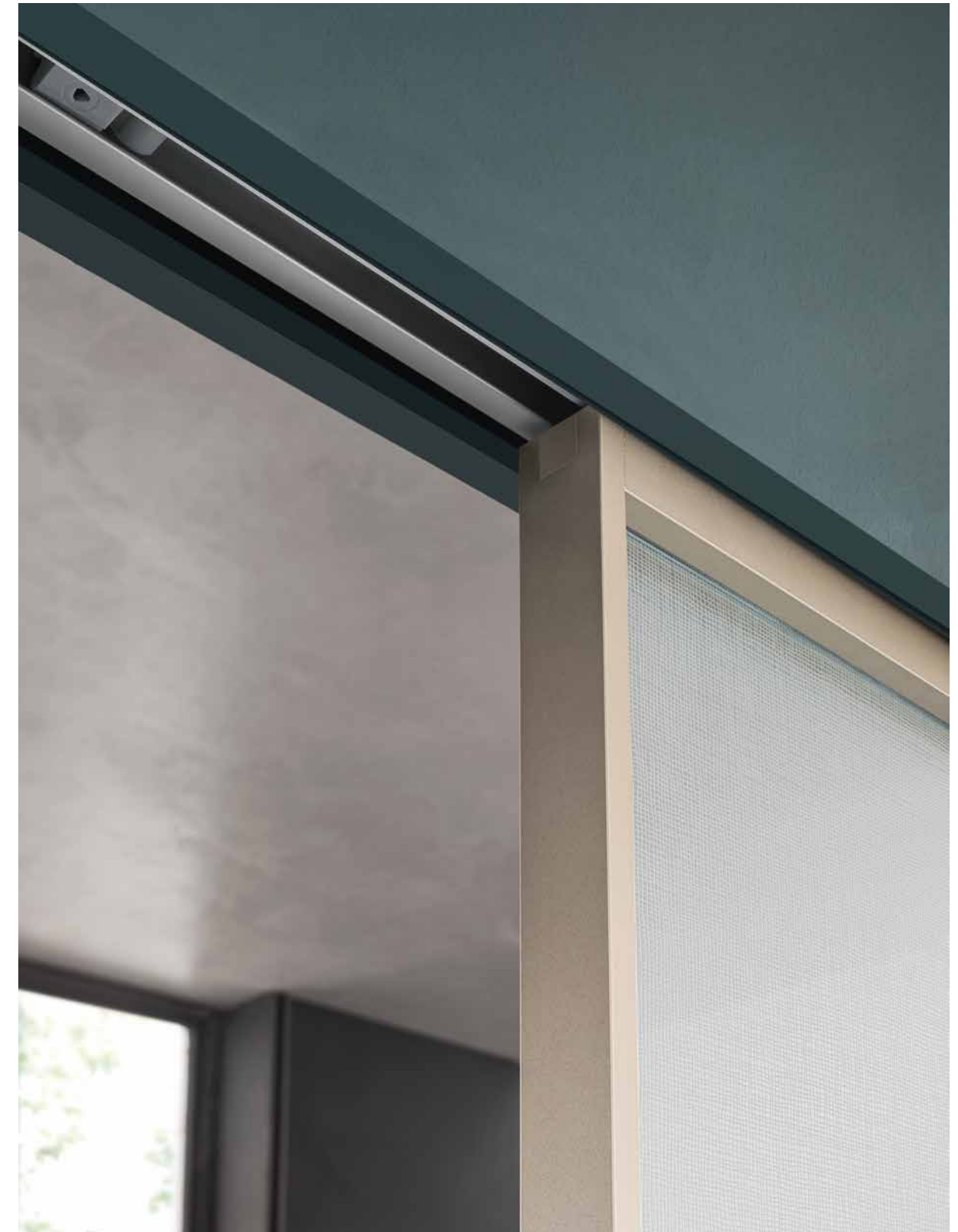

**Sistema di scorrimento interno muro Minima**  
Sliding door system inside the wall Minima

**La bellezza  
e la leggerezza  
del vetro  
diventano  
protagoniste  
assolute nei  
sistemi di apertura.  
Libere, animano  
la parete.**

The beauty and the lightness of the glass become absolute protagonist on opening system. Free, bring life to the wall.

**Vitrum - Line**  
**Vitrum - Move**

**Battente**  
swing door

**Box**

**Bilico**  
pivot door

**Scorrevole**  
sliding door

## Vitrum-Line **Battente / Box / Bilico**

Swing system / Box / Pivot door

**Battente** > 075

**Box** > 081

**Bilico** > 083



La tipologia di vetro non è solo una scelta estetica ma trova espressione anche nella sua funzionalità. Scegliere un vetro satinato, ad esempio, è la soluzione ideale per creare nel dialogo tra le stanze una certa intimità. La porta divide le stanze ma, allo stesso tempo, la sua brillantezza mantiene aperta la continuità visiva degli spazi. Nei toni del bronzo, la continuità spaziale si riflette anche nell'accordo perfetto con il colore della parete in cui si inserisce.

**Divide without separate in a clear way.**

The glass type is not only an aesthetic choice, express itself in functionality too. Choosing a satin glass, for example, is the ideal solution to create intimacy and privacy between rooms. The door divides spaces but in the meantime its brightness keeps the visual continuity between spaces. In case of bronzed glass, this continuity reflect itself in the match between the door and the wall finishing as well.

**Dividere  
senza  
separare  
in modo  
netto.**

Vitrum-Line BATTENTE  
**L 800 x H 2400 mm**  
VB02 Vetro Bronzo Satinato  
VB02 Satin Bronze Glass



Satinato nei toni del grigio, il vetro della porta si veste di eleganza e trova il suo spazio ideale in ambienti dal carattere moderno, dagli ambienti domestici agli uffici. La luce riflette sulla superficie e esalta la brillantezza del vetro, che inserito in un ambiente total white, amplifica la percezione degli spazi e alleggerisce i volumi. Oltre il vetro, la vista è leggera ma trova la giusta privacy. Gli ambienti sono separati dalla leggerezza del vetro ma uniti dalla completezza dello stile.

**Light doors for enlighten architectures.**

Smoked satin, the glass of the door dresses with elegance and finds its ideal place in modern spaces, houses or offices. The light reflects the surface and enhances the glass brightness. When the glass is in a total white place, it magnify and lighten spaces. Alongside the glass the view is light but with privacy. Spaces becomes separated due to the glass lightness but joined together due to the style.

**Porte leggere per architetture luminose.**

Vitrum-Line BATTENTE  
**L 800 x H 2400 mm**  
 VV02 Vetro Extrachiario Satinato  
 VV02 Satin Extraclear Glass







**Particolare cerniera V-719**  
Detail of the V-719 hinge



**Particolare serratura V-720 UV**  
Detail of the V-720UV lock

Vitrum-Line BATTENTE  
**L 800 x H 2700 mm**  
VB01 Vetro Bronzo Trasparente  
VB01 Transparent Bronze Glass

**Dettagli  
funzionali  
decorano  
le porte.**

Il vetro è versatile e si adatta a diversi sistemi di apertura. Nella versione box, a singola o doppia anta, l'apertura è agevole e resa sicura grazie all'inserimento di preziosi dettagli, come le maniglie in coordinato con le cerniere che regolano l'efficienza del movimento. Un design leggero che apre alla funzionalità. Ideali per dividere con discrezione, anche a tutta altezza, e modellare gli spazi creando stanze nelle stanze, attraverso una soluzione con apertura saloon.

**Functional  
details decorate doors.**

The glass is versatile and adapt to several opening systems. In case of box, single or double, the opening is easy and safe thanks to some precious details, like matching handles or regulating hinges. A light design opens to the functionality. This is the ideal solution, in order to divide in a discreet way, even ceiling height, and mold spaces creating "room inside room", in a "saloon" opening solution.



**Particolare cerniera HY-CO**  
Detail of the HY-CO hinge

Vitrum-Line BOX  
**L 850 + 850 x H 2400 mm**  
VG01 Vetro Grigio Trasparente  
VG01 Transparent Smoked Glass



**Particolare inferiore cerniera Hydra**  
Detail of the lower pivot Hydra hinge

Vitrum-Line BILICO  
**L 900 x H 2700 mm**  
VV01 Vetro Extrachiario Trasparente  
VV01 Transparent Extraclear Glass

## Vitrum - Move **Scorrevole** | Sliding system

**SKY / BASIC / LUCE / MINIMA / MULTY 80-81 / MAGIC**

Sistema di scorrimento - Sliding system

<b>Sky</b>	> 086
<b>Luce</b>	> 091
<b>Basic</b>	> 095
<b>Minima</b>	> 099
<b>Multy 80</b>	> 103
<b>Multy 81</b>	> 105
<b>Magic</b>	> 107



Il movimento fluido dello scorrimento delle porte anima le pareti che dividono le stanze. Il vetro dialoga con gli ambienti attraverso la sua leggerezza diventando parte integrante dell'arredo in cui si inserisce. Le porte che si inseriscono in un sistema con guide incassate nel soffitto creano un impatto visivo strutturale ancora più leggero, in quanto il meccanismo di scorrimento risulta nascosto. Tutto scorre ma lo stile resta lo stesso, la porta completa e integra la parete.

**Doors slide,  
walls become dynamic.**  
Fluid movement of the sliding "animate" walls that separate rooms. The glass talk to spaces through its light, becoming part of the furnishing. Doors insert themselves in a system with built-in guides and create a lighter visible effect. The sliding system looks totally hidden. Everything slide but style remains the same, the door complete the wall.

**Le porte  
scorrono,  
le pareti  
diventano  
dinamiche.**



Vitrum-Move SKY  
**L 750 x H 2700 mm**  
VV02 Vetro Extrachiaro Satinato  
VV02 Satin Extraclear Glass

Vitrum-Move SKY  
**L 1000 + 1000 x H 2700 mm**  
VO07 Vetro Lino  
VO07 Lino Glass

Gli ambienti prendono forma attraverso l'incontro della trasparenza del vetro con la luce. Progetti di luce che creano effetti vedo-non vedo per separare gli ambienti con discrezione senza dividerli in modo netto. L'anta anima la parete con un movimento leggero sino a raggiungere l'anta fissa a cui si sovrappone. La bellezza del vetro resta sempre a vista. Soluzioni ideali per dividere in modo pratico ambienti di grandi dimensioni senza nascondere del tutto l'anima della stanza.

**The brightness plays with the glass transparency.** Spaces take the shape when the glass transparency meets the light. Light projects create seen-not seen effect to separate spaces in a discreet way. The door "animate" the wall with a light movement until it reaches the fixed panel to be overlapped. The beauty of the glass remains visible. Ideal solutions to divide in practice way big spaces without hiding the "soul" of the room.

**La  
luminosità  
gioca con  
la trasparenza  
del vetro.**

Vitrum-Move LUCE-S  
**L 950 x H 2700 mm**  
+ fisso | + fix  
VG01 Vetro Grigio Trasparente  
VG01 Transparent Smoked Glass



Ci sono spazi che si aprono in modo particolare alla convivialità, come la cucina. In fase di progettazione dell'ambiente può nascere la necessità di separare la zona lavoro dalla zona pranzo. L'inserimento di pareti in vetro scorrevoli è una soluzione leggera che lascia aperti gli spazi dell'ambiente grazie a una continuità visiva e allo stesso tempo li chiude in modo funzionale quando c'è l'esigenza di maggiore intimità e privacy. Anche divisi, gli spazi si guardano e comunicano tra loro.

**An open dialog between spaces.**  
There are spaces adapted for communication, as kitchen. During the project phase of spaces there may be the need to separate the working area to the dining zone. Inserting glass sliding walls is a light solution that leave spaces open. These spaces may be closed when privacy is needed. When divided, spaces communicate between them.

**Un dialogo  
aperto  
tra gli  
ambienti.**

Vitrum-Move LUCE-S  
**L 1000 + 1000 x H 2700 mm**  
VV01 Vetro Extrachiario Trasparente  
VV01 Trasparent Extraclear Glass





**Lo stile  
delle velette  
riflesso negli  
effetti decor.**

**Cover  
profiles style  
reflect to  
decor effects.**

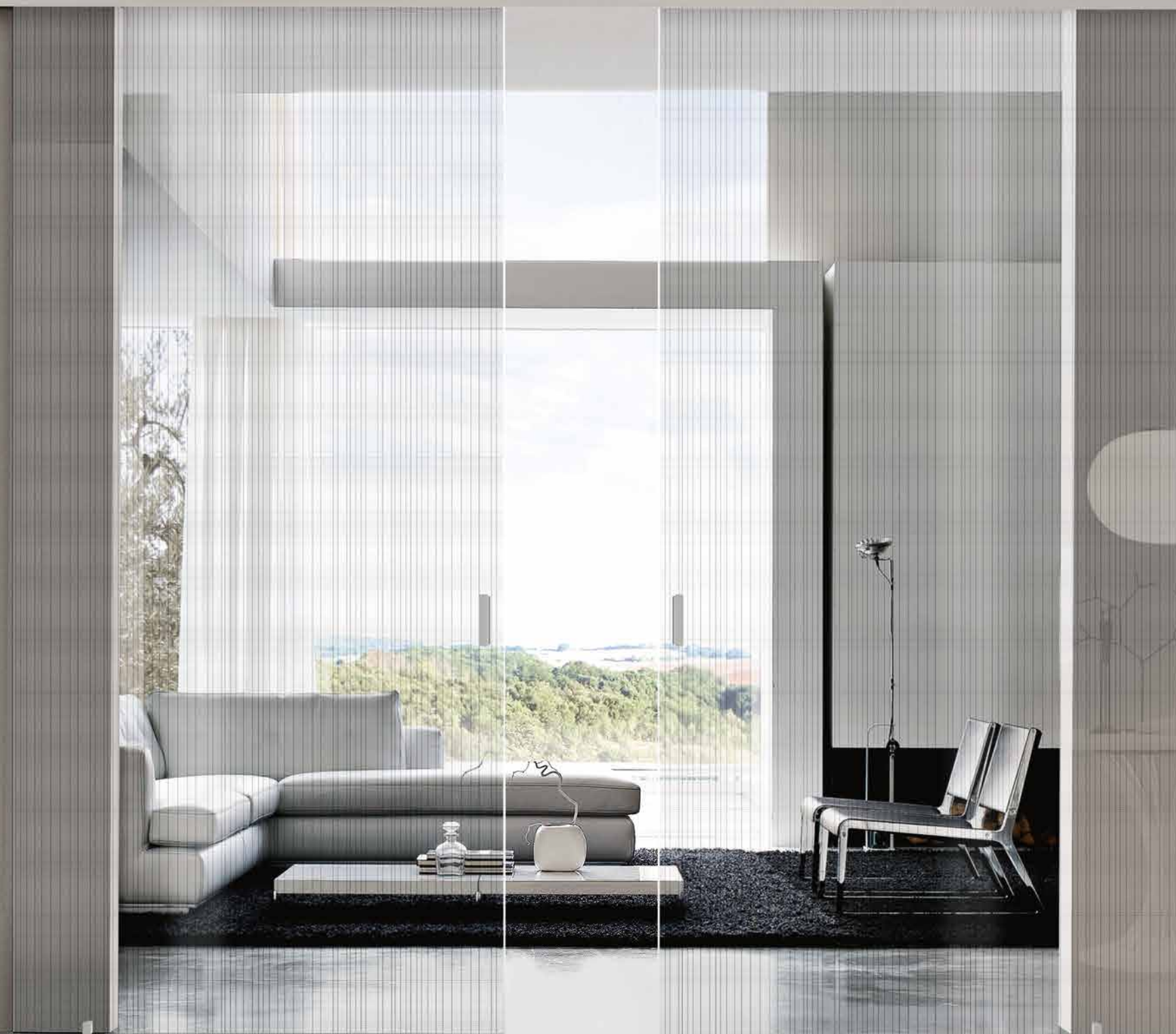

Vitrum-Move BASIC  
**L 1200 + 1200 x H 2400 mm**  
VS01 Vetro Cyber  
VS01 Cyber Glass

**Basic porta  
l'eleganza  
con sé in uno  
scorrimento  
fluido.**

L'eleganza del bronzo dialoga con le scelte cromatiche dell'arredo interno alla stanza. Porte che aprono e completano lo stile.

**Basic brings the elegance with a flowing sliding.** The elegance of the bronze talks and communicates to the colour chosen on furnishings inside the wall. Doors open and complete the style.



**Sistema di scorrimento Basic con trascinamento**  
Basic sliding system with dragging

Vitrum-Move BASIC  
con trascinamento | with dragging  
**L 1200 + 1200 x H 2400 mm**  
VB01 Vetro Bronzo Trasparente  
VB01 Transparent Bronze Glass



**Porte  
che  
liberano  
e salvano  
spazio.**

I sistemi scorrevoli definiscono gli ambienti a seconda delle esigenze. In presenza di spazi di piccole dimensioni, l'inserimento di una porta con scorrimento interno muro risulta una soluzione salvaspazio ottimale. La porta c'è ma non si vede: si nasconde totalmente nel momento dell'apertura lasciando libera la parete da ogni ingombro e mette in comunicazione le stanze. La varietà delle soluzioni cromatiche applicate al vetro determina il livello di intimità che vogliamo dare ad ogni ambiente.

**Doors that free and save space.** Sliding systems define the environments depending on needs. In case of small spaces, the insert of a sliding door inside the wall is the best safe space solution.

The door is there but it's not visible: it hides completely when opening, leaving the wall without obstacles and permit rooms to communicate together.

The variety of colour solutions available for glasses gives the level of intimacy that we want to give to any space.

Vitrum-Move MINIMA  
**L 800 x H 2100 mm**  
VG01 Vetro Grigio Trasparente  
VG01 Transparent Smoked Glass



**Vetri  
dai toni  
neutri per  
mood  
moderni.**

La porta dialoga con lo stile degli ambienti, non è solo un elemento strutturale ma diventa un arredo che cerca l'armonia nel contesto. Il vetro grigio si adatta ad uno stile moderno dal carattere minimal ed essenziale. Un colore neutro che con delicatezza si inserisce senza svelare del tutto il contenuto delle stanze comunicanti per lasciare privacy. L'aggiunta di elementi come le serrature aumentano la funzionalità della porta e la sicurezza di chi abita.



**Serratura V-150WC**  
V-150WC lock

**Glass with neutral tone for modern mood.**  
The door talks to the style of spaces, it is not only a structural element, but becomes a furnish piece looking for harmony. The grey glass adapt itself to a modern style, with minimal and essential look. A neutral and elegance colour that inserts itself without revealing what's inside near rooms, in order to give them privacy. The adding of elements as locks gives more functionality and safety to people.

Vitrum-Move MINIMA  
**L 1000 x H 2400 mm**  
VL10 Vetro Laccato Lucido Ardesia  
VL10 Ardesia Glossy Lacquered Glass



**La creatività  
ruota attorno  
agli elementi  
strutturali.**

Le ante sono impreziosite da una texture geometrica che gioca con la trasparenza e la luminosità del vetro. Con movimento fluido la porta arreda ambienti dallo spirito creativo dove elementi strutturali, come le ruote a vista, diventano decorativi.

**The creativity around  
structural elements.**

Doors are decorated with a geometric texture that plays with the transparency and the lightness of the glass. With a fluid movement, the door decorates spaces with a creative spirit where structural elements, as visible wheels, become decorative too.

Vitrum-Move MULTY 80  
**L 900 x H 2400 mm**

VV01 Vetro Extrachiario Trasparente con stampa Digital  
VV01 Transparent Extraclear Glass with Digital print



**Le porte  
svelano  
il fascino  
trasparente  
del vetro.**

La veletta accompagna lo scorrimento della porta sulla parete e svela poco a poco elementi strutturali come le ruote a vista. Gli aspetti funzionali e strutturali appaiono in modo essenziale per lasciare spazio alla trasparenza del vetro, che svela la bellezza degli ambienti e li divide in modo quasi impercettibile. Soluzioni ottimali per illuminare le stanze e per arredare ambienti domestici ma anche uffici dallo stile moderno e contemporaneo.

**Doors reveal the glass transparent appeal.**  
Functional and structural aspects appear as essential in order to give space to the transparency of the glass. The glass shows the beauty of spaces and divides them softly. Optimal solutions to enlighten home environments and to furnish rooms and modern offices.

Vitrum-Move MULTY 81  
**L 900 x H 2400 mm**  
VV01 Vetro Extrachiario Trasparente  
VV01 Trasparent Extraclear Glass

Vitrum-Move MAGIC  
**L 900 x H 2400 mm**  
VV01 Vetro Extrachiaro Trasparente  
VV01 Trasparent Extraclear Glass



Vitrum-Move MAGIC  
**L 900 x H 2700**  
VL19 Vetro Laccato Lucido Fumo  
VL19 Smoked Glossy Lacquered Glass



## Specifiche tecniche e finiture vetri.

Technical details  
and glass finishes.



## Quadro-Line Battente | Swing system

### Anta battente in vetro con telaio

Anta in vetro con telaio proposto in varie finiture per porte visivamente leggere, ma estremamente funzionali. È disponibile solo con traverso superiore.

### Glass swing door with frame

Glass door with frame suggested in several finishings for light but functional doors. The upper beam is available.

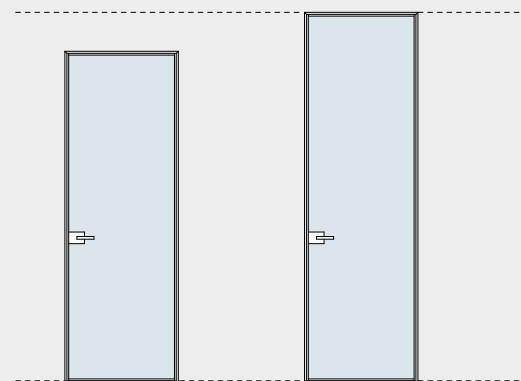

In luce  
Between 2 walls

A soffitto  
Ceiling

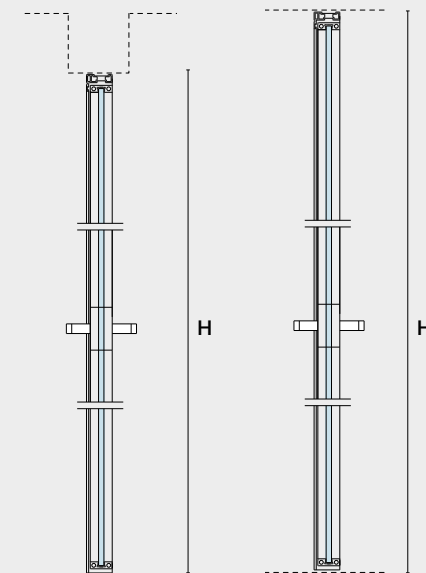

Altezze da 2000 a 2700 mm  
Height from 2000 to 2700 mm

### Porta a tirare

Quadro-Line è disponibile per anta singola a tirare. L'apertura verso l'esterno può essere a destra o a sinistra.

### Pull door

Quadro-Line is available for single door with pull opening. The opening toward the outer side can be right or left.

Muratura - Cartongesso  
Brickwall - Plasterboard

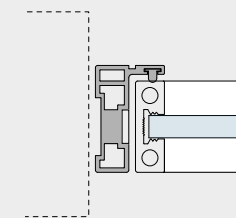

Singola  
Single

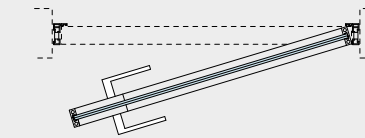

Larghezza da 600 a 1000 mm  
Width from 600 to 1000 mm

### Porta a spingere

Quadro-Line è disponibile per anta singola a spingere. L'apertura verso l'interno può essere a destra o a sinistra.

### Push door

Quadro-Line is available for single door with push opening. The opening toward the inner side can be right or left.

Muratura - Cartongesso  
Brickwall - Plasterboard

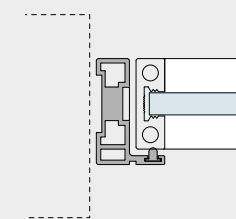

Singola  
Single

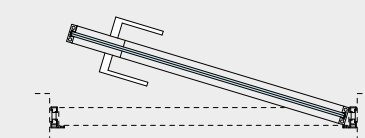

Larghezza da 600 a 1000 mm  
Width from 600 to 1000 mm

### Finiture telaio

Frame finishes

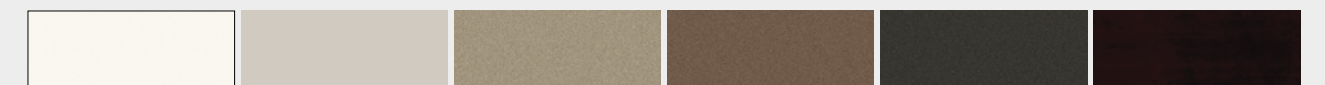

LO01  
Bianco - White

LO20  
Nuvola - Cloud

LM33  
Nichel - Nickel

LM34  
Bronzo - Bronze

LM36  
Grafite - Graphite

LO12  
Nero - Black

## Quadro-Frame Battente | Swing system

### Anta battente in vetro con telaio e stipite

Anta in vetro con telaio e stipite proposto in varie finiture per porte visivamente leggere, ma estremamente funzionali.

### Glass swing door with frame and jamb

Glass door with frame suggested in several finishings for light but functional doors.

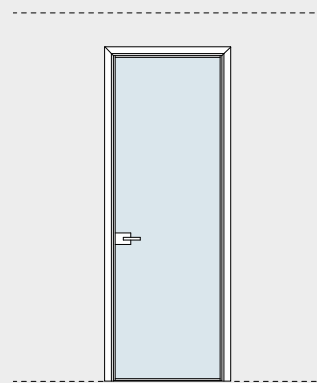

### Con stipite With jamb

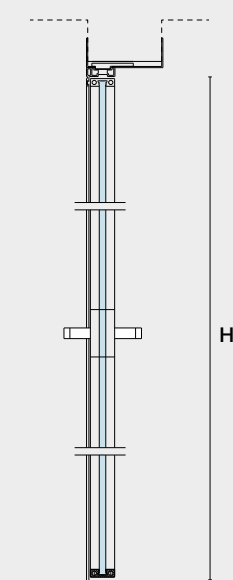

Altezze da 2000 a 2700 mm  
Height from 2000 to 2700 mm

### Porta a tirare

Quadro-Frame con apertura a tirare verso l'esterno è predisposta per l'installazione su parete con intonaco oppure in presenza di struttura in cartongesso.

### Pull door

Quadro-Frame with pull opening toward the outer side is prearranged for the installation on brickwall or plasterboard.

### Muratura - Cartongesso Brickwall - Plasterboard

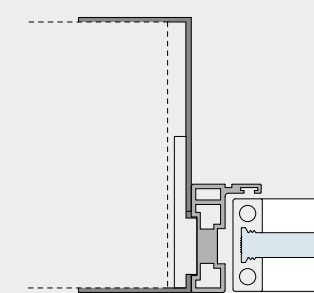

### Singola Single

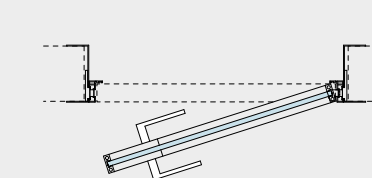

Larghezza da 600 a 1000 mm  
Width from 600 to 1000 mm

### Porta a spingere

Quadro-Frame a spingere si apre verso l'interno e può essere installata su parete in muratura oppure in presenza di struttura in cartongesso.

### Push door

Quadro-Frame with push opening toward the inner side may be installed on brickwall or plasterboard.

### Muratura - Cartongesso Brickwall - Plasterboard

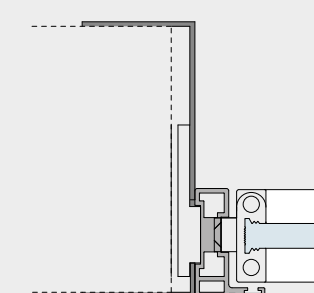

### Singola Single

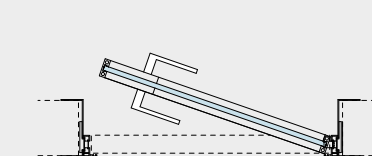

Larghezza da 600 a 1000 mm  
Width from 600 to 1000 mm

### Finiture telaio Frame finishes

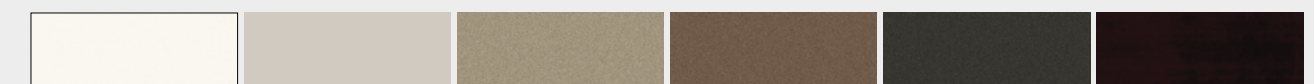

**LO01** Bianco - White    **LO20** Nuvola - Cloud    **LM33** Nichel - Nickel    **LM34** Bronzo - Bronze    **LM36** Grafite - Graphite    **LO12** Nero - Black

# Quadro-Line Bilico | Pivot door

## Anta bilico in vetro

L'anta bilico in vetro con telaio e apertura bidirezionale, ruota attorno al proprio asse verticale. Il bilico bidirezionale è disponibile anche a tutta altezza con o senza stipite ed è pensato soprattutto per gli ampi spazi.

## Pivot glass door

The glass pivot door with frame and bidirectional opening, rotate around its vertical axis. The bidirectional pivot can also be ceiling, with or without jamb and it is adapt for big spaces.

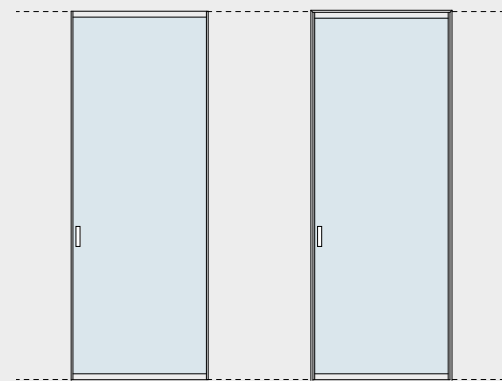

**Bilico**  
Senza stipite  
Without jamb

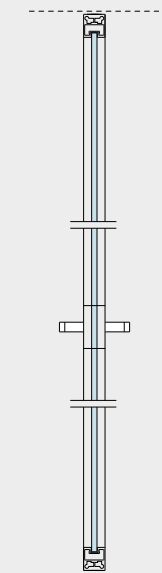

**Bilico - Frame**  
Con stipite  
With jamb

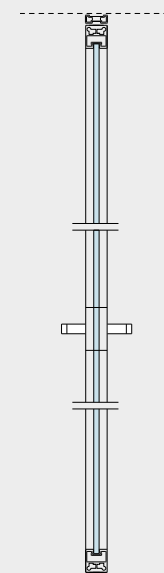

Altezze fino a 2700 mm  
Height up to 2700 mm

## Porta bidirezionale

L'apertura bidirezionale, sia a spingere che a tirare è disponibile con o senza sistema di chiusura automatico.

## Bidirectional door

The bidirectional opening, both push and pull is available with or without self closing system.

**Bilico**  
Singola senza stipite  
Single without jamb

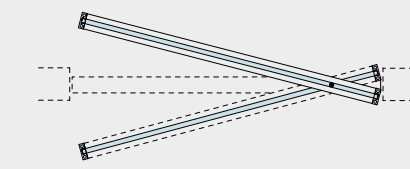

Larghezza fino a 1500 mm  
Width up to 1500 mm

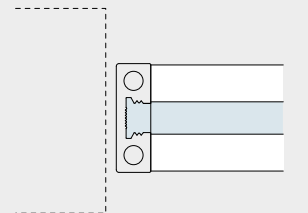

**Bilico - Frame**  
Singola con stipite  
Single with jamb

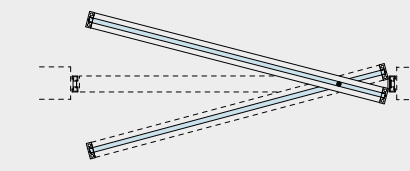

Larghezza fino a 1500 mm  
Width up to 1500 mm

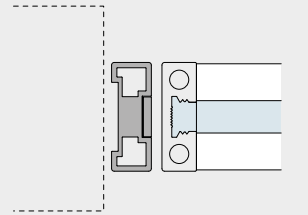

## Finiture telaio

Frame finishes

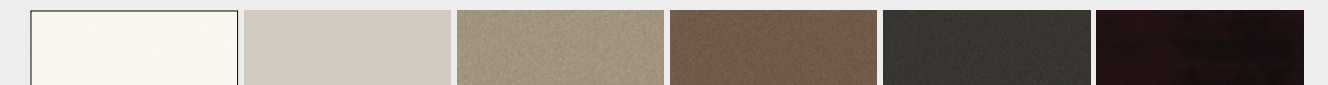

**LO01** Bianco - White    **LO20** Nuvola - Cloud    **LM33** Nichel - Nickel    **LM34** Bronzo - Bronze    **LM36** Grafite - Graphite    **LO12** Nero - Black

# Quadro-**Move** **Scorrevole** | Sliding system

## SKY

Porta con telaio singola o doppia con binario incassato a soffitto.

Door with frame single or double with built-in rail.



## LUCE-S

Porta con telaio doppia con binario incassato a soffitto in luce.

Door with frame double with 2ways built-in rail.

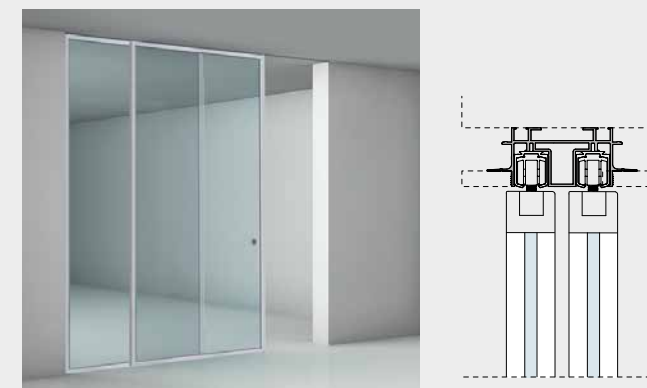

## BASIC

Porta con telaio singola o doppia con velette.

Door with frame single or double with cover profile.



## LUCE-B

Porta con telaio doppia con binario in luce con velette.

Door with frame double with 2ways rail with cover profile.

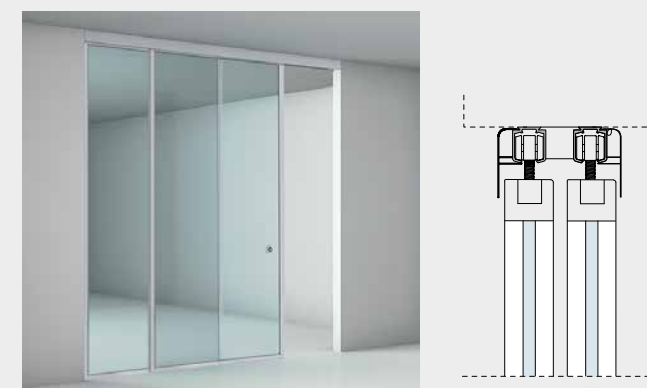

## MINIMA







Porta con telaio singola o doppia a scomparsa interno muro.

Door with frame single or double inside the wall.

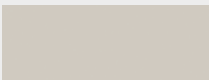
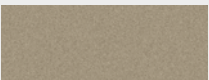
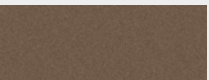
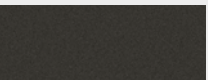

## Finiture telaio

Frame finishes

					
<b>NC01</b> Noce Canaletto - American walnut	<b>FO01</b> Frassino Oliva - Olive ash	<b>RN01</b> Rovere Naturale - Natural oak	<b>RS01</b> Rovere Scuro - Dark oak		
					
<b>LO01</b> Bianco - White	<b>LO20</b> Nuvola - Cloud	<b>LM33</b> Nichel - Nickel	<b>LM34</b> Bronzo - Bronze	<b>LM36</b> Grafite - Graphite	<b>LO12</b> Nero - Black

## Vitrum-Line Battente | Swing system

### Anta battente in vetro

Vitrum-Line esprime una grande libertà dimensionale e creativa per porte speciali. Vitrum-Line è anche porta a tutta altezza, con o senza traverso, per ottenere la massima integrazione tra porta, parete e soffitto.

### Glass swing door

Vitrum-Line states a dimensional and creative freedom for special doors. Vitrum-Line can also reach the ceiling, with or without beam, in order to obtain a joining between door, wall and ceiling.

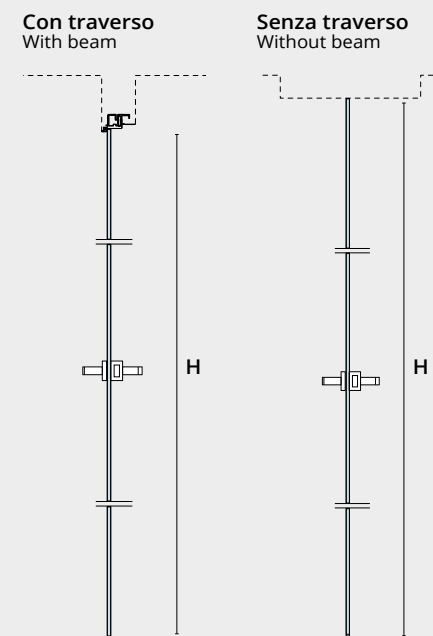
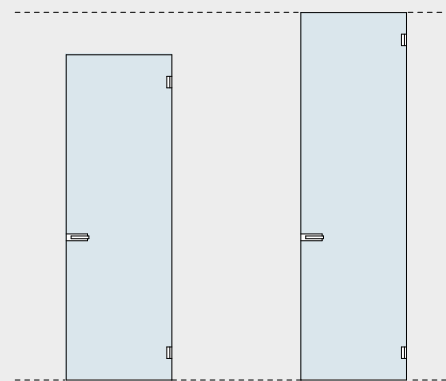

Altezze da 2000 a 2700 mm  
Height from 2000 to 2700 mm

### Porta a tirare

Vitrum-Line a tirare permette un'apertura verso l'esterno, lato in cui è presente il rasomuro. L'apertura può essere a destra o a sinistra.

### Pull door

Vitrum-Line pull door permits an opening toward the outer side, which is the flush side. Opening side can be right or left.

Muratura  
Brickwall

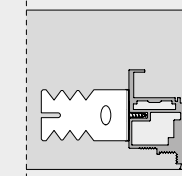

Cartongesso  
Plasterboard

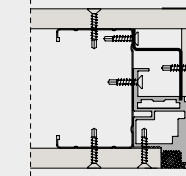

Singola  
Single

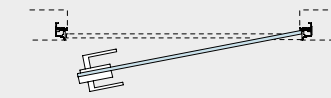

Larghezza da 600 a 1000 mm  
Width from 600 to 1000 mm

Doppia  
Double

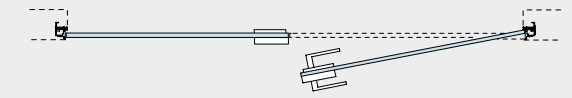

Larghezza da 1200 a 1800 mm  
Width from 1200 to 1800 mm

### Porta a spingere

Vitrum-Line a spingere permette l'apertura con una spinta verso l'interno della stanza. L'apertura può essere a destra o a sinistra.

### Push door

Vitrum-Line permits to open pushing toward the inner side of the room. Opening side can be right or left.

Muratura  
Brickwall

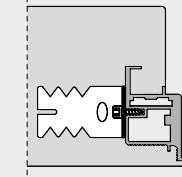

Cartongesso  
Plasterboard

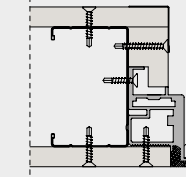

Singola  
Single



Larghezza da 600 a 1000 mm  
Width from 600 to 1000 mm

Doppia  
Double



Larghezza da 1200 a 1800 mm  
Width from 1200 to 1800 mm

## Vitrum-Line Bilico | Pivot door

### Anta bilico in vetro

L'anta Bilico in vetro ruota attorno al proprio asse verticale e può essere installata in luce o a soffitto.

#### Pivot glass door

The pivot glass door rotates around its vertical axis and can be installed between 2 walls or ceiling.

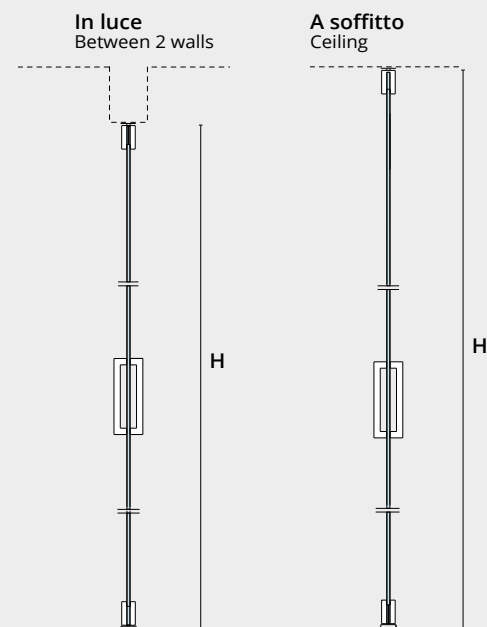
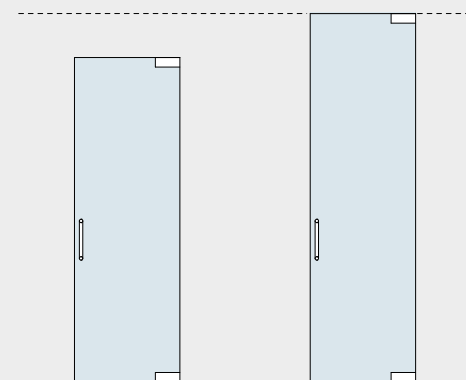

### Porta bidirezionale

Vitrum-Line Bilico ha un'apertura dell'anta bidirezionale, sia a tirare che a spingere, con possibilità di essere installata anche su struttura in cartongesso.

#### Bidirectional door

Vitrum-Line Pivot has a bidirectional opening, both pull and push, with the chance to be installed on plasterboard.

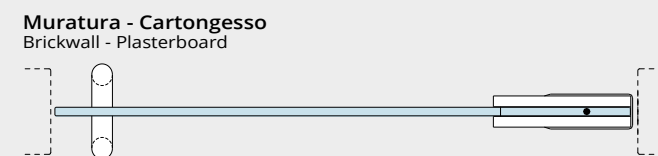
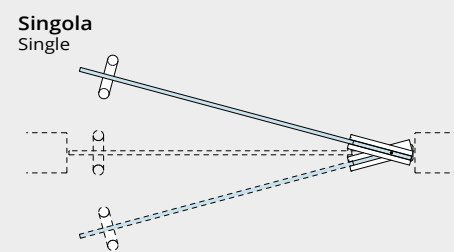

Altezze fino a 2700 mm / Larghezza fino a 1000 mm  
Height up to 2700 mm / Width up to 1000 mm

## Vitrum-Line Box | Box door

### Anta box in vetro

Anta Box in vetro con apertura bidirezionale, con cerniere oleodinamiche fissate a muro. Può essere installata in luce o a soffitto.

#### Glass box door

Glass box with bidirectional opening, with oleodynamic hinges hung to the wall. It can be installed between 2 walls or ceiling.

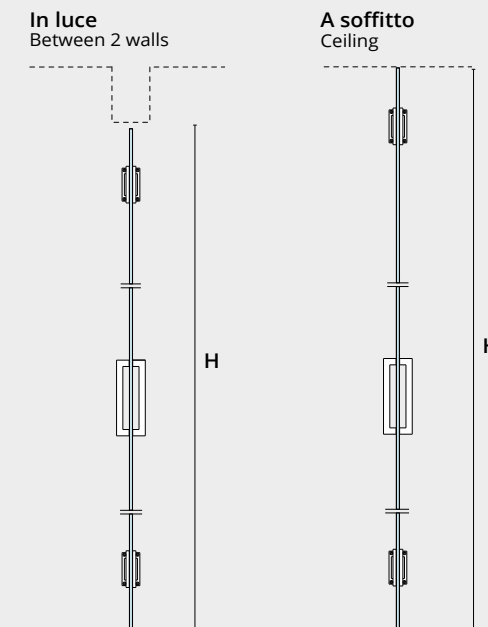
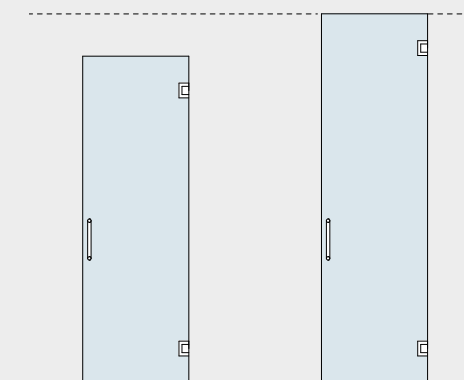

### Porta bidirezionale

Vitrum-Line Box ha un'apertura dell'anta bidirezionale, sia a tirare che a spingere, con possibilità di essere installata anche su struttura in cartongesso.

#### Bidirectional door

Vitrum-Line Box has a bidirectional opening, both pull and push, with the chance to be installed on plasterboard.

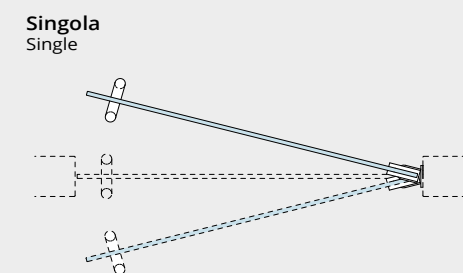

Altezze fino a 2700 mm / Larghezza fino a 1000 mm  
Height up to 2700 mm / Width up to 1000 mm

## Vitrum Move Scorrevole - Sliding system

### SKY

Singola o doppia  
con binario incassato.  
Single or double sliding  
door with built-in rail.



### LUCE-S

Doppia o  
singola + fissa con  
binario incassato  
a soffitto in luce.  
Double or single  
+ fix sliding door  
with built-in rail  
in the opening.

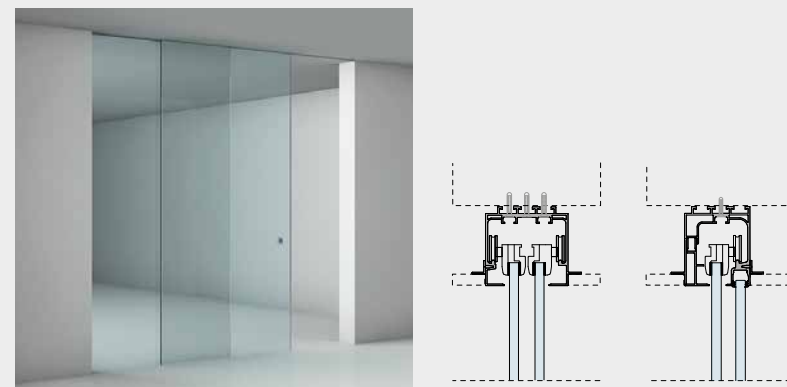

### LUCE-B

Doppia o  
singola + fissa  
con binario in  
luce con velette.  
Double or  
single + fix sliding  
door with rail in  
the opening and  
cover-profile

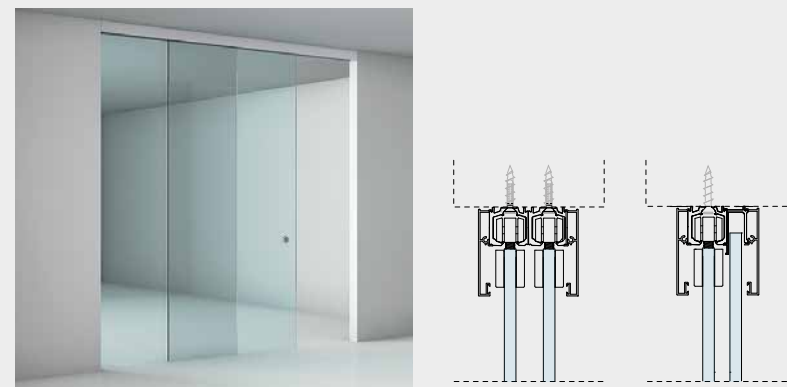

### BASIC

Singola o doppia  
con velette.  
Single or double  
sliding door with  
cover-profile.



### MINIMA

Singola o doppia  
a scomparsa  
interno muro.  
Single or double  
sliding door into  
the wall.



### MULTY 80

Singola o doppia con  
scorrimento a ruote  
e borchie a vista.  
Single or double  
with visible wheels  
and caps sliding  
mechanism.



### MULTY 81

Singola o doppia  
con scorrimento  
a ruote e veletta.  
Single or double  
with visible wheels  
and cover profile  
sliding mechanism.



### MAGIC

Singola o doppia con  
binario a scomparsa.  
Single or double sliding  
door with hidden rail.



## Quadro Maniglie - Handles

### Battenti - Swing doors



**Q-120**  
Serratura con maniglia  
Lock with handle

**Q-120WC**  
Serratura con maniglia e nottolino  
Lock with handle and latch

### Scorrevoli - Sliding doors



**L-50\***

**P-19**

**D-30\***

**F-27**



**Q-150WC**  
Serratura con nottolino  
Lock with latch

### Finiture maniglie - Handles finishes

\* **Essenza: solo per maniglie L-50 e D-30, porte scorrevoli Quadro** - Wood: only for handles L50 and D30 for Quadro sliding doors



**NC01**  
Noce Canaletto -  
American walnut

**FO01**  
Frassino Oliva -  
Olive ash

**RN01**  
Rovere Naturale -  
Natural oak

**RS01**  
Rovere Scuro -  
Dark oak

**Laccato per tutte le maniglie porte scorrevoli e battenti Quadro** - Lacquered for all handles for Quadro doors, sliding and swing



**LO01**  
Bianco - White

**LO20**  
Nuvola - Cloud

**LM33**  
Nichel - Nickel

**LM34**  
Bronzo - Bronze

**LM36**  
Grafite - Graphite

**LO12**  
Nero - Black

## Vitrum Maniglie - Handles

### Battenti - Swing doors



**V-750**  
Serratura con maniglia  
Lock with handle

**V-720UV**  
Serratura con maniglia e nottolino  
Lock with handle and latch

**R-10**  
Il modello R10 è disponibile:  
R10 handle is available:  
Ø25x300 - Ø25x650 - Ø30x1000

### Scorrevoli - Sliding doors

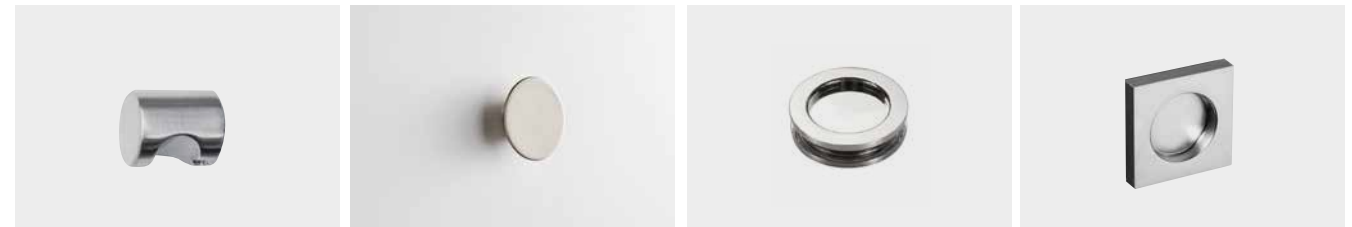

**B-168**

**P-19**  
Finitura laccata Bianco - Nero  
White - Black lacquered finishes

**V-524**

**V-522**

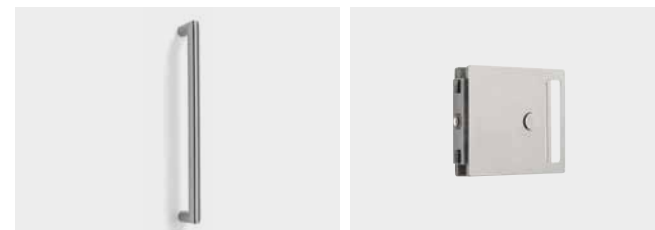

**R-10**  
Il modello R10 è disponibile:  
R10 handle is available:  
Ø25x300 - Ø25x650 - Ø30x1000

**V-150WC**  
Serratura senza chiave  
Lock without key

### Finiture maniglie - Handles finishes

**Finiture per tutte le maniglie porte scorrevoli e battenti Vitrum** - Finishing for all handles for sliding and swing Vitrum doors



**Cromo Lucido**  
Glossy Chrome

**Cromo Satinato**  
Chrome Satin

**Inox Satinato**  
Satin stainless steel

**Nichel Satinato**  
Satinized Nickel

**Alluminio Anodizzato**  
Anodized Aluminium

**V-750**  
**V-720UV**  
**B-168**  
**V-524**  
**V-522**

**V-750**  
**V-720UV**  
**B-168**

**R-10**  
**V-150WC**

**V-524**  
**V-522**

**V-524**  
**V-522**



### Vetri - Glass



**VV02**  
Extrachiaro Satinato  
Satin Extrachiaro

**VG02**  
Grigio Satinato  
Satin Smoked

**VB02**  
Bronzo Satinato  
Satin Bronzo

**VV01**  
Extrachiaro Trasparente  
Transparent Extrachiaro

**VG01**  
Grigio Trasparente  
Transparent Smoked

**VB01**  
Bronzo Trasparente  
Transparent Bronze

### Vetri texture - Texture glass



**VS01** Cyber

**VO06** Vintage

**VO07** Lino

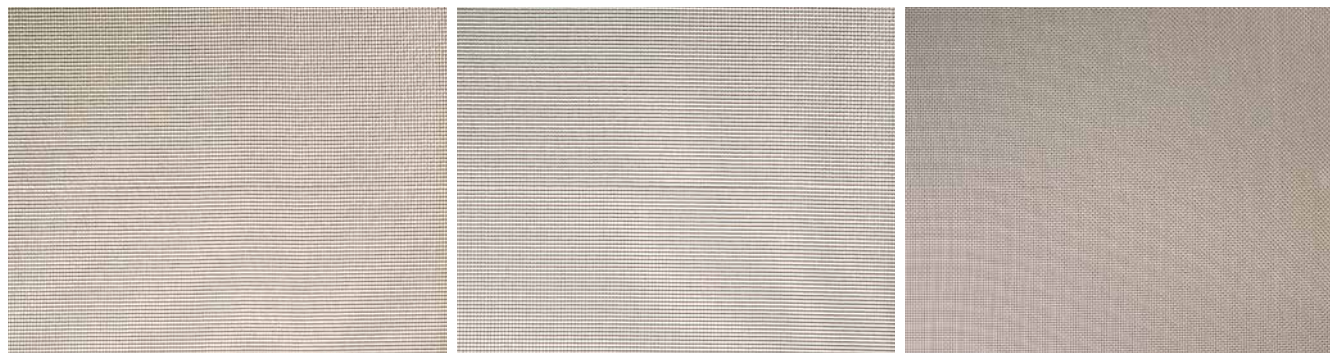

**VT02** Mesh Gold

**VT03** Mesh Silver

**VT04** Luxor

### Vetri laccati lucidi e satinati - Glossy and satin lacquered glass

### Finiture telaio - Frame finishes



**NC01**  
Noce Canaletto -  
American walnut

**FO01**  
Frassino Oliva -  
Olive ash

**RN01**  
Rovere Naturale -  
Natural oak

**RS01**  
Rovere Scuro -  
Dark oak

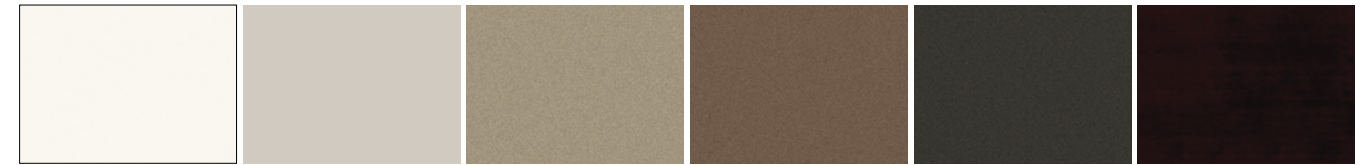

**LO01**  
Bianco - White

**LO20**  
Nuvola - Cloud

**LM33**  
Nichel - Nickel

**LM34**  
Bronzo - Bronze

**LM36**  
Grafite - Graphite

**LO12**  
Nero - Black

### Inserti telaio Quadro - Quadro frame inserts

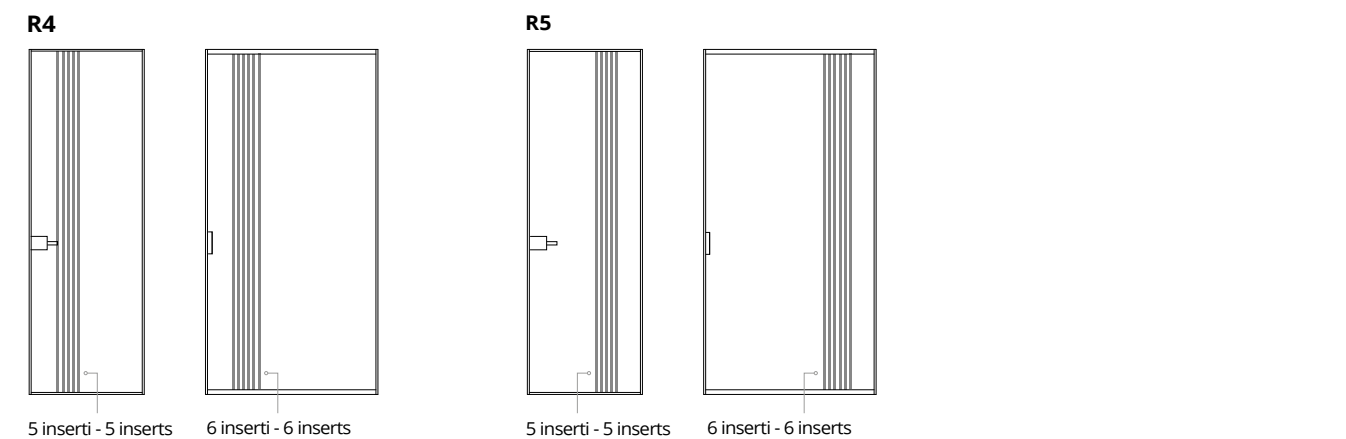
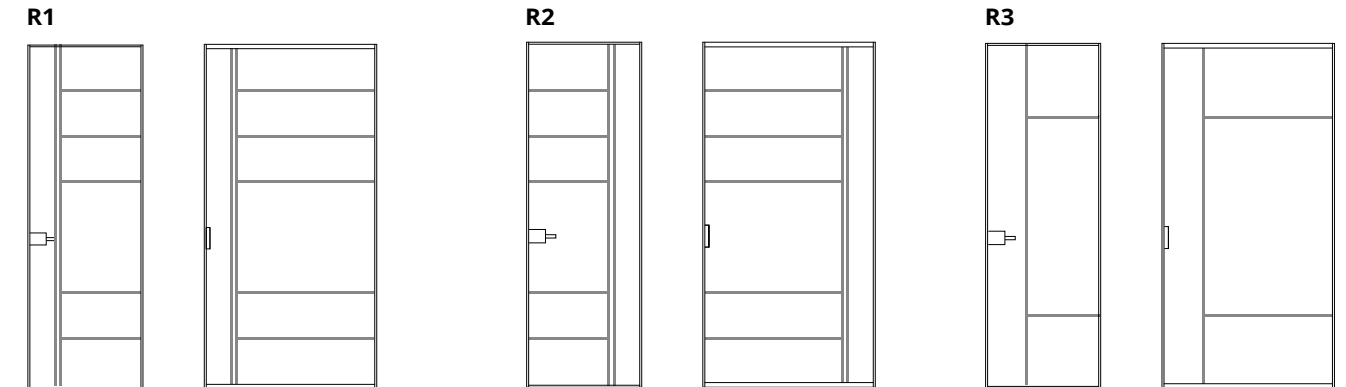

5 inserti - 5 inserts

6 inserti - 6 inserts

5 inserti - 5 inserts

6 inserti - 6 inserts

concept & graphic design  
**Lokomotiv**

photo & rendering  
**Indoor**

styling  
**Rossi & Co**

colour separation & print  
**Luce**

July 2020

**BLUINTERNI**  
ITALIAN ARCHITECTURAL DOORS

FIAM srl  
Via Castellana, 15  
31010 Cimadolmo (Tv) Italy  
T. +39 0422 748839  
[www.bluinterni.it](http://www.bluinterni.it) [info@bluinterni.it](mailto:info@bluinterni.it)

FIAM srl  
Via Castellana,15  
31010 Cimadolmo (TV) - Italy  
T. +39 0422 748839

[www.bluinterni.it](http://www.bluinterni.it) [info@bluinterni.it](mailto:info@bluinterni.it)