

MIE
and
my
systems

MisuraEmme®

INSTANCABILE E LABORIOSO CONTRIBUTO AI VALORI DEL "MADE IN ITALY".

IN MISURAEMME, LE DIMENSIONI E LE POTENZIALITÀ INDUSTRIALI DI OGGI COSTITUISCONO UN PATRIMONIO COSTRUITO NEL TEMPO. UN LUNGO PERIODO DEDICATO AD AFFINARE LA CONOSCENZA DEI MOLTEPLICI REQUISITI CHE FANNO DI UN'IMPRESA UNA GRANDE MARCA. TUTTE LE PROPOSTE MISURAEMME SONO CREAZIONI ORIGINALI PRODOTTE IN ITALIA. SONO IL RISULTATO DI MONITORAGGI ATTENTI AGLI SCENARI DELLA CONTEMPORANEITÀ E AI LORO CAMBIAMENTI, SONO IL FRUTTO DI UN ATTEGGIAMENTO COMPLESSIVO NEI CONFRONTI DELLE DIFFUSE QUALITÀ PERMEATO DI COMPETENZA, TENACIA E ENTUSIASMO, SONO MANUFATTI USCITI DALLA NOSTRA FABBRICA E NATI DA UNA COLLAUDATA RELAZIONE IN PONDERATO EQUILIBRIO TRA LE PERFORMANTI CAPACITÀ PRODUTTIVE TIPICHE DEI GRANDI NUMERI E LO SLANCIO PROGETTUALE DA STILISTA.

INDUSTRIOUS AND UNTIRING CONTRIBUTION TO "MADE IN ITALY" VALUES.

MISURAEMME'S CURRENT INDUSTRIAL DIMENSION AND POTENTIAL REPRESENT A STRONG HERITAGE THAT HAS BEEN BUILT OVER TIME. A LONG HISTORY DEDICATED TO A CONSTANTLY EVOLVING KNOW-HOW, DEFINING THE COMPANY AS AN INTERNATIONALLY-RECOGNIZED BRAND. ALL MISURAEMME DESIGNS ARE ORIGINAL "MADE IN ITALY" CREATIONS. THEY REPRESENT AN ATTENTIVE MONITORING OF MARKET TRENDS AND CHANGES; WELL-ROUNDED PRODUCTS WITH EXCLUSIVE QUALITY AS THEIR MAIN AMBITION, PERMEATED WITH THE COMPANY'S TENACIOUS ENTHUSIASM AND MANUFACTURED DIRECTLY ON OUR PREMISES-PART OF A TESTED BALANCE BETWEEN THE PERFORMANCE CAPACITIES TYPICAL OF SERIAL PRODUCTION AND STYLISTIC FLAIR OF A TRUE DESIGNER.

INTERIOR

INSPIRATION

TAO . CROSSING . URBAN

COLLEZIONE GIORNO

LIVING AREA COLLECTION

STILE ESSENZIALE, DESIGN CONTEMPORANEO E FUNZIONALITÀ SCANDISCONO LA ZONA GIORNO IN UN'ARMONIA RICERCATA TRA FORME, MATERIALI E FINITURE. GEOMETRIE LINEARI E VOLUMI SCULTOREI MODULANO LO SPAZIO LIVING CON SOBRIA ELEGANZA. PER UNA NUOVA FILOSOFIA DELL'ABITARE CHE RIASSUME QUALITÀ, INNOVAZIONE E RISPETTO PER L'AMBIENTE.

ESSENTIAL STYLE, CONTEMPORARY DESIGN AND FUNCTIONALITY ARE KEY CONCEPTS OF THE DAY AREA, IN PERFECT BALANCE BETWEEN FORMS, MATERIALS AND FINISHINGS. LINEAR GEOMETRIES AND SCULPTURAL VOLUMES MODULATE THE LIVING INTERIOR WITH SOBER ELEGANCE. FOR A NEW LIVING PHILOSOPHY, EMBRACING QUALITY, INNOVATION AND RESPECT FOR THE ENVIRONMENT.



In queste pagine e in quelle successive: composizione **Tao** con contenitori in finitura laccato lucido. Mensola top sp. 80 mm e boiserie in essenza Rovere Tinto Nero. Mensole in alluminio anodizzato con illuminazione LED Zaffiro. Sistema **Maggie** composto da bussolotti, teche e vani a giorno in legno o vetro, con cassettoni svuotatasche in cuoio. Contenitore sospeso rivestito in pelle scamosciata con cuciture a vista e top in marmo. Divano **Argo** con rivestimento in tessuto sfoderabile ed elementi libreria in finitura essenza Olmo Grey. Tavolini **Kessler** con base in metallo canna di fucile e piano in vetro grigio fumé. Pouf **Stone** imbottito e rivestito in pelle stampata canestrino. Poltroncina **Violetta** con base girevole in metallo e rivestimento bicolore.

On these and next pages: **Tao** composition with containers in glossy lacquered finishing. Shelf counter 80 mm thick and boiserie in Black Painted Oak. Shelves in anodised aluminium with LED Zaffiro lighting. **Maggie** system consisting of die boxes, display cases and wood or glass compartments, with small "pocket emptier" drawers in thick-leather. Suspended container covered in suede with visible stitching and marble top. **Argo** sofa with removable fabric cover and bookcase elements in Elm Grey wood finishing. **Kessler** side tables with gun metal base and Fumè grey glass top. Upholstered **Stone** Pouf covered in canestrino printed leather. **Violetta** armchair with metal rotating base and two-tone covering.





A fianco: dettaglio composizione **Tao** con boiserie e mensola top sp. 80 mm in essenza Rovere Tinto Nero. Sistema **Maggie** composto da bussolotti, teche e vani a giorno in legno o vetro, con cassettoni svuotatasche in cuoio. Pouf **Stone** imbottito e rivestito in pelle stampata canestrino.

To the side: detail of **Tao** composition with boiserie and shelf top 80 mm thick in Black Painted Oak. **Maggie** system consisting of die boxes, display cases and wood or glass compartments, with small "pocket emptier" drawers in thick-leather. Upholstered **Stone** Pouf covered in canestrino printed leather.





CONGON Amabile

In queste pagine: composizione **Tao** con boiserie e mensola top sp. 80 mm in essenza Rovere Tinto Nero. Sistema **Maggie** composto da bussolotti, teche e vani a giorno in legno o vetro, con cassettoni svuotatasche in cuoio. Tavolo **Gaudi** con base in massello Rovere Tinto Nero e piano in marmo Sahara Noir. Sedie **Bertha** con struttura in essenza Rovere Tinto Nero e sedile rivestito in tessuto.

On these pages: **Tao** composition with boiserie and shelf top 80 mm thick in Black Painted Oak. **Maggie** system consisting of die boxes, display cases and wood or glass compartments, with small "pocket emptier" drawers in thick-leather. **Gaudi** Table with base in solid Black Painted Oak and top in Sahara Noir marble. **Bertha** chairs with structure in Black Painted Oak and fabric clad seat.





A fianco: un dettaglio della composizione **Tao** con boiserie e mensola top sp. 80 mm in essenza Rovere Tinto Nero. Sistema **Maggie** composto da bussolotti, teche e vani a giorno in legno o vetro, con cassettini svuotatasche in cuoio. Tavolo **Gaudi** con base in massello Rovere Tinto Nero e piano in marmo Sahara Noir. Sedie **Bertha** con struttura in essenza Rovere Tinto Nero e sedile rivestito in tessuto e Pouf **Stone** imbottito e rivestito in pelle stampata canestrino.

On the side: detail of **Tao** composition with boiserie and shelf top 80 mm thick in Black Painted Oak. **Maggie** system consisting of die boxes, display cases and wood or glass compartments, with small "pocket emptier" drawers in thick-leather. **Gaudi** Table with base in solid Black Painted Oak and top in Sahara Noir marble. **Bertha** chairs with structure in Black Painted wood and fabric clad seat, along with the upholstered **Stone** Pouf covered in canestrino printed leather.



Nelle pagine precedenti e in queste: composizione **Crossing**, finitura struttura laccato opaco grigio lava, schienali in essenza Rovere Cenere, anta ribalta in essenza Rovere Fumè, raster sp.14 mm laccato opaco grigio lava ed elemento **Tao** integrato, in essenza Rovere Fumè. Divano **Argo** in tessuto sfoderabile. Tavolino foglia **Gramercy** con piano e sottopiano laccato lucido e base in massello Rovere Tinto Nero. Tavolino rotondo **Gramercy**, con struttura in massello in finitura Rovere Tinto Nero e piano in marmo Calacatta Oro. Poltrona **WM1**, disegnata da W. Max Moser della collezione *Atelier* di MisuraEmme® con struttura in metallo cromato e cuscini di seduta e schienale rivestiti in pelle sfoderabile. Tavolini **Ring**, con struttura in metallo satinato, piani in vetro grigio fumè e marmo Marquinia.

On previous and these pages: **Crossing** composition, matt lacquered lava grey structure finishing, backs in Oak wood, flap down door in Fumè Oak wood, raster 14 mm thick in matt lacquered lava grey and integrated **Tao** element, in Fumè Oak wood. **Argo** sofa in removable fabric. **Gramercy** leaf low table with glossy lacquered top and under top and base in solid Black Painted Oak. **Gramercy** round side table, with solid wood structure in Black Painted Oak finishing and top in Calacatta Gold marble. **WM1** armchair, designed by W. Max Moser from the *Atelier* collection by MisuraEmme® with chromed metal structure, seat cushions and back with removable leather cover. **Ring** side tables with structure in satin metal, Fumè grey glass and Marquinia marble top.



A sinistra: dettaglio della composizione **Crossing**, finitura struttura laccato opaco grigio lava, schienali in essenza Rovere Cenere, modulo in essenza Rovere Fumé, raster sp.14 mm laccato opaco grigio lava. Illuminazione LED Zaffiro. Divano **Argo** con rivestimento in tessuto sfoderabile e piedi in metallo nichel satinato.

To the left: detail of **Crossing** composition, matt lacquered lava grey structure finishing, backs in Oak wood, module in Fumé Oak wood, raster 14 mm thick matt lacquered lava grey. LED Zaffiro lighting. **Argo** sofa with removable fabric cover and brushed nickel metal feet.





In queste pagine: composizione **Crossing**, finitura struttura laccato opaco grigio lava, schienali in essenza Rovere Cenere, ante in essenza Rovere Fumè, raster sp.14 mm laccato opaco grigio lava, elemento integrato **Palo Alto Day** con ante **Teka** vetro fumè, montanti centrali con vetro fumè e luce LED Zaffiro. Tavolini quadrati **Gramercy** con struttura in massello finitura Rovere Tinto Nero, piano in marmo Marquinia ed essenza Rovere Cenere, sottopiano laccato lucido. Divano **Madison** con rivestimento in tessuto sfoderabile e piedi in metallo nichel satinato.

On these pages and on the previous ones: **Crossing** composition, structure mat lacquer grigio lava, back panels in wood veneer Oak Cenere, flap door in wood veneer Oak fumè, raster 14 mm thickness mat lacquer grigio lava, with **Palo Alto Day** unit equipped with **Teka** grey fumè glass doors with central uprights with insert in glass grey fumè and Zaffiro LED lights. **Gramercy** square small tables base in solid oakwood black stained and top in Marquinia marble and wood veneer Oak Cenere, undersurface glossy lacquer. **Madison** sofa with removable cover and feet in satinated metal.





Sopra: dettaglio dell'anta "Bar" del sistema **Crossing**. A destra e nelle pagine successive: composizione **Crossing**, finitura struttura laccato opaco grigio lava, schienali in essenza Rovere Cenere, ante in essenza Rovere Fumé, raster sp. 14 mm laccato opaco grigio lava, elemento integrato **Palo Alto Day** con ante **Teka** in vetro grigio Fumé, montanti centrali con vetro fumè e illuminazione LED Zaffiro. Tavolini quadrati **Gramercy** con struttura in massello finitura Rovere Tinto Nero, piano in marmo Marquinia ed essenza Rovere Cenere, sottopiano laccato lucido. Divano **Madison** con rivestimento in tessuto sfoderabile e piedi in metallo nichel satinato. Poltrona **Ermes** con rivestimento in tessuto e base girevole in acciaio.

Above: detail of "Bar" flap down door on **Crossing** system. On these pages and on the previous ones: **Crossing** composition, structure mat lacquer grigio lava, back panels in wood veneer Oak Cenere, flap door in wood veneer Oak fumé, raster 14 mm thickness mat lacquer grigio lava, with **Palo Alto Day** unit equipped with **Teka** grey Fumé glass doors with central uprights with insert in glass grey fumé and Zaffiro LED lights. **Gramercy** square small tables base in solid oakwood black stained and top in Marquinia marble and wood veneer Oak Cenere, undersurface glossy lacquer. **Madison** sofa with removable cover and feet in satinized metal. **Ermes** armchair with cover in fabric and swivel base in satinized stainless steel.

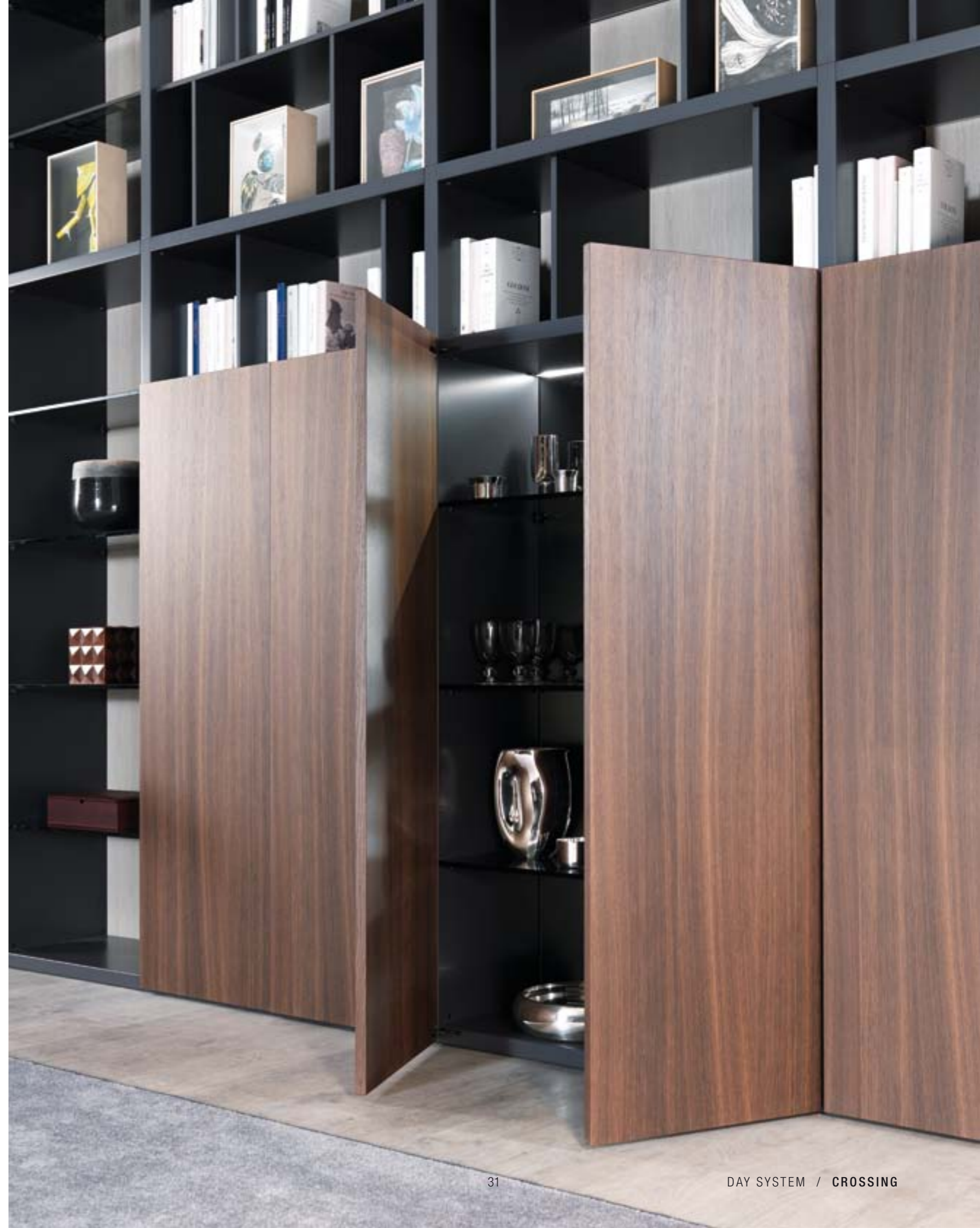



In queste pagine: divano **Madison** con rivestimento in tessuto sfoderabile e piedi in metallo nichel satinato. Tavolini **Kessler** con base in alluminio finitura canna di fucile e piano in marmo Calacatta Oro e vetro Fumè. Tavolini **Gramercy** con base in massello finitura Rovere Tinto Nero e piano in vetro grigio Fumè e marmo Marquinia. Su sfondo composizione **Crossing** con elementi libreria laccati opachi, schienale in essenza Rovere Cenere, elemento **Palo Alto Day** integrato con ante **Teka** vetro Fumè, schienali in essenza Rovere Cenere, montanti centrali con vetro grigio Fumè e luce LED Zaffiro.

On these pages: **Madison** sofa with removable fabric cover and brushed nickel metal feet. **Kessler** side tables with gun metal aluminium base and top in Calacatta Gold marble and Fumè glass. **Gramercy** tables with base in Black Painted Oak finishing solid wood and top in grey Fumè glass and Marquinia marble. In the background: **Crossing** composition with opaque lacquered bookcase elements, back in Oak Cenere wood, **Palo Alto Day** element integrated with Fumè glass Teka doors, Oak Cenere wood backs, central uprights with Fumè glass and LED Zaffiro light.





In queste pagine: composizione **Crossing**, finitura struttura laccato opaco grigio lava, schienali in essenza Rovere Cenere e Tecno-Marble, raster sp. 14 mm laccato opaco grigio lava, elemento integrato **Palo Alto Day** con ante **Teka** in vetro grigio Fumè, montanti con vetro grigio Fumè e luce LED Zaffiro e ripiani vetro grigio Fumè.

On these pages: **Crossing** composition with matt lacquered lava grey structure finishing, backs in Oak Cenere wood and Tecno-Marble, raster 14 mm thick matt lacquered lava grey, integrated element **Palo Alto Day** with grey Fumé glass **Teka** doors, uprights with grey Fumé glass and Zaffiro LED light and grey Fumé glass shelves.

In queste pagine: composizione **Crossing**, finitura struttura laccato opaco grigio lava, schienali in essenza Rovere Cenere, boiserie in finitura Tecno-Marble, materiale in gres porcellanato con un design naturale ispirato al marmo con mensole in alluminio anodizzato e illuminazione LED Zaffiro. Madia **Kessler** sospesa in essenza Rovere Fumè. Poltrone **Florentia** con rivestimento bicolore (pelle stampata sul retro e pelle liscia sulla parte anteriore), con base in massello Rovere Tinto Nero.

On these pages: **Crossing** composition with matt lacquered lava grey structure finishing, backs in Oak Cenere wood, boiserie in Tecno-Marble finishing, a material in porcelain stoneware with a natural design, inspired by marble, with shelves in anodized aluminium and Zaffiro LED lighting. **Kessler** suspended cabinet in Oak Fumè wood. **Florentia** armchairs with two-tone cover (printed leather on back and smooth leather on front), with base in solid Black Painted Oak wood.







Nelle pagine precedenti e in queste: composizione **Tao** con contenitori in finitura essenza Rovere Fumè e laccato opaco grigio lava, elementi libreria **Crossing** laccati opachi, Boiserie in laccato lucido e in finitura Tecno-Marble, materiale in gres porcellanato con un design naturale ispirato al marmo. Tavolino **Kessler** con base in alluminio satinato e piano in essenza Rovere Fumè. Divano **Argo** con rivestimento in tessuto sfoderabile.

On the preceding pages and on these pages: **Tao** composition with containers in veneered Oak Fumè and matt lacquer finishes, **Crossing** bookshelf elements in matt lacquered finish, paneling in Techno-Marble and glossy lacquered finishes. **Kessler** coffee table with base in satined aluminum and top in veneered Oak Fumè. **Argo** sofa with removable fabric cover.





A destra: dettaglio della composizione **Tao** con contenitori in finitura essenza Rovere Fumè, elementi libreria **Crossing** laccati opachi, Boiserie in finitura Tecno-Marble e laccato lucido. Sopra: dettaglio della Boiserie in finitura Tecno-Marble, materiale in gres porcellanato con un design naturale ispirato al marmo.

Right: details of the **Tao** composition with containers in veneered Oak Fumè, **Crossing** bookshelf elements in matt lacquered finish, paneling in Techno-Marble and glossy lacquered finishes. Above: details of the paneling in Techno-Marble finish, material is unglazed porcelain with a natural design inspired by marble.

In queste pagine e nelle pagine precedenti: sistema libreria a parete **Urban** in finitura laccato opaco grigio lava, frontali e pannello TV in essenza Rovere Fumè. Divano **Argo** con rivestimento in tessuto sfoderabile. Tavolino **Kessler** con base in alluminio satinato e piano in marmo Bianco Carrara. Pouf rettangolare **Cannes** con base in metallo nichel satinato e rivestimento in pelle.

In these pages and in the previous ones: **Urban** bookcase wall system in matt lacquered finish with front panels in veneered Oak fumè. **Argo** sofa with removable fabric cover. **Kessler** coffee table with base in satined aluminum and Bianco Carrara marble top. **Cannes** rectangular ottoman with leather cover and satin nickel metal base.







A sinistra: tavolo **Gramercy** con struttura in legno massello Rovere tinto nero e piano in vetro grigio Fumè distanziato dalla base attraverso nottolini in acciaio inox. Sopra: particolare del sistema libreria **Urban** con scatole in metallo verniciato di sp. 2 mm.

Left: **Gramercy** table with solid wood structure in stained black Oak finish and top in grey Fumé glass spaced from the base with stainless steel supports. Above: details of the **Urban** bookcase; the 2 mm thick painted metal boxes.



In queste pagine e in quelle precedenti: sistema libreria a parete **Crossing Teka** con finitura laccata opaca Cappuccino integrata a sistema bussolotti **Tao**, sospesi ad una Boiserie in essenza Rovere Fumè. Tavolo **Gramercy** con struttura in legno massello finitura Rovere tinto nero e piano in vetro grigio Fumè. Poltroncina **Archetto** con base in legno massello finitura Rovere tinto nero e rivestimento della seduta in velluto.

In these pages and in the previous ones: **Crossing Teka** wall bookcase system with matt lacquered finish and **Tao** cabinet system hanging on a fumè oak veneered paneling (Boiserie). **Gramercy** table with solid wood structure, black stained oak finish and grey Fumè glass top. **Archetto** small armchair with solid wood base, black stained oak finish and velvet seating cover.





In queste pagine: sistema libreria a parete **Urban** in finitura laccato opaco. Pannello TV e frontali in nobilitato Olmo Grey. Modulo centrale porta TV con ante scorrevoli in vetro grigio Fumè riflettente e maniglie in alluminio satinato. Illuminazione LED Zaffiro. Divano **Argo** con rivestimento in tessuto sfoderabile e piedi in metallo canna di fucile. Tavolini **Argo** in legno con finitura Rovere Fumè. Poltroncina **Archetto** con base in legno massello finitura Rovere Tinto Nero e rivestimento della seduta in velluto.

On these pages: **Urban** wall-mounted bookcase system in opaque lacquered finishing. TV and front panel in melamine Grey Elm finishing. Central TV module with sliding doors in grey Fumè reflective glass and brushed aluminium handles. LED Zaffiro lighting. **Argo** sofa with removable fabric cover and brushed nickel metal feet. **Argo** side tables in wood with Smoky Oak finishing. **Archetto** armchair with solid wood base in Black Painted Oak finishing and velvet clad seat.





Sopra: dettaglio maniglia in alluminio satinato per anta scorrevole. A fianco: dettaglio sistema libreria a parete **Urban** in finitura laccato opaco. Schienale e frontali in nobilitato Olmo Grey. Modulo centrale porta TV con ante scorrevoli in vetro grigio Fumè riflettente e maniglie in alluminio satinato. Vani contenitore a ribalta in nobilitato Olmo Grey. Illuminazione LED Zaffiro.

Above: detail of brushed aluminium handle for sliding door. To the side: detail of **Urban** wall-mounted bookcase system in matt lacquered finishing. Back and front parts in melamine Grey Elm. Central TV module with sliding doors in Fumè grey reflective glass and brushed aluminium handles. Drop front storage features in melamine Grey Elm. LED Zaffiro lighting.





Nelle pagine precedenti e in queste: composizione **Crossing Teka**, finitura struttura laccato opaco grigio pietra, schienale laccato opaco grigio lava, ante **Teka** in vetro grigio Fumè con ripiani vetro sp. 12 mm. Illuminazione faretto LED. Poltrona **Ermes** con base in massello Rovere Fumè e rivestimento in velluto. Chaise longue **Antibes** in tessuto sfoderabile con base in massello di Rovere Fumè e piedino rastremato. Tavolini quadrati **Hill**, con struttura in massello Rovere Fumè e piani in marmo Bianco Carrara e marmo Emperador.

On previous and these pages: **Crossing Teka** composition, matt lacquered stone-grey finishing structure, opaque lacquered lava grey back, **Teka** doors in grey Fumè glass with 12 mm glass tops. LED lighting. **Ermes** armchair with solid Oak Fumè base and velvet cover. **Antibes** chaise longue in removable fabric with solid Oak Fumè base and tapered foot. Square **Hill** side tables with structure in solid Oak Fumè and tops in White Carrara marble and Emperador marble.





A sinistra: dettaglio composizione **Crossing Teka**, finitura struttura laccato opaco grigio pietra, schienale laccato opaco grigio lava, ante **Teka** in vetro grigio Fumè con ripiani vetro sp. 12 mm. Illuminazione faretto LED.

To the left: detail of **Crossing Teka** composition, matt lacquered stone-grey finishing structure, opaque lacquered lava grey back, **Teka** doors in grey Fumè glass with 12 mm glass shelves. LED lighting.

In queste pagine e in quelle successive: sistema libreria a parete **Urban** in finitura laccato opaco. Frontali in finitura laccato lucido Cappuccino. Modulo porta TV con anta scorrevole in finitura vetro laccato Caolino. Scatole in metallo verniciato sp. 2 mm. Poltrona **Florentia** con struttura in acciaio e imbottitura in poliuretano schiumato a freddo, rivestimento in tessuto o pelle. Tavolino rotondo **Sushi** con struttura in metallo satinato e piano laccato opaco Cappuccino.

On these and following pages: **Urban** wall-mounted bookcase system in matt lacquered finishing. Front in glossy lacquered Cappuccino finishing. TV module with sliding door in lacquered glass Caolino finishing. Boxes in painted metal 2 mm thick. **Florentia** armchair with steel structure and upholstery in cold foamed polyurethane, fabric or leather cover. **Sushi** round table with satinated metal structure and matt lacquered Cappuccino top.





In queste pagine: Composizione **Crossing** sospesa con modulo porta TV, elementi libreria laccato opaco Argilla. Contenitori a ribalta 'UP' finitura laccato lucido Sepia. Mensola piano top sp. 80 mm finitura laccato lucido Argilla.

On these pages: Suspended **Crossing** compositions with TV module element, in matt lacquered Argilla. "UP" drop front containers with glossy lacquered Sepia finishing. Shelf counter top 80 mm glossy shiny lacquered Argilla finishing.





In queste pagine: composizione **Tao** con contenitori e mensola top sp. 80 mm laccato lucido Argilla. Boiserie in essenza Rovere Tinto Nero. Panca a terra sp. 80 mm in essenza Rovere Tinto Nero. Mensole in alluminio anodizzato. Poltrona **Quadria** con base in massello Rovere Tinto Nero e rivestimento in pelle.

On these pages: **Tao** composition with containers and shelf top 80 mm thick in matt lacquered Argilla. Boiserie in Black Painted Oak. Floor bench 80 mm thick in Black Painted Oak. Shelves in anodised aluminium. **Quadria** armchair with solid Black Painted oak base and leather cover.



FOCUS ON

TECHNICAL DETAILS

TAO . CROSSING . URBAN

TAO

ELEMENTI COSTITUTIVI / COMBINED ELEMENTS

PANNELLO TV CON LED
HANGING LED TV PANEL



MENSOLE IN ALLUMINIO
RETROILLUMINATE CON LUCI LED
LED HANGING WITH LED ALUMINIUM SHELVES



CASSETTI
DRAWERS



ANTE 'UP' E 'DOWN'
'UP' AND 'DOWN' DOORS



ANTA BATTENTE TOP 6 MM
HINGED DOOR TOP 6 MM



MENSOLE IN ALLUMINIO AD 'L'
'L' SHAPED ALUMINIUM SHELVES

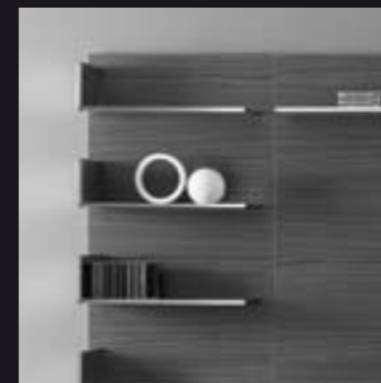

CONTENITORI MAGGIE CON CASSETTI
CONTAINERS MAGGIE WITH DRAWERS



CONTENITORI PENSILI
HANGING UNITS

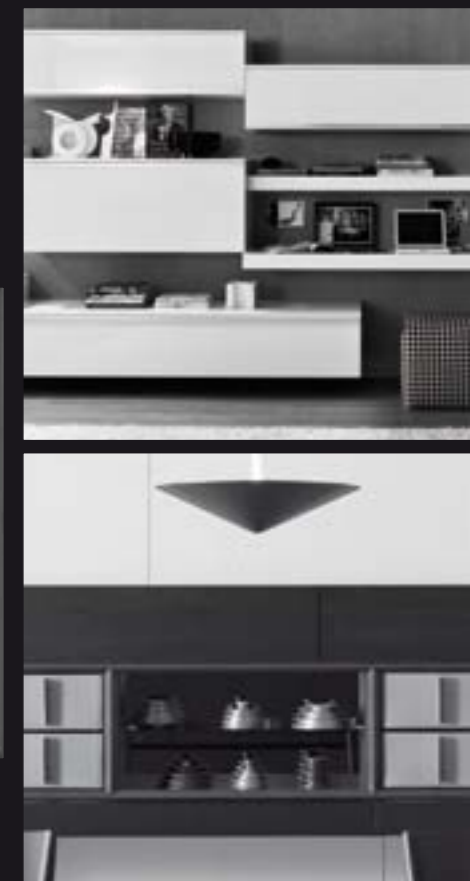

ANTA BATTENTE TOP 20 MM
HINGED DOOR TOP 20 MM



ANTA BATTENTE
HINGED DOORS



PANCHE A TERRA
FLOOR BENCHES



BOISERIE '00'
PANNELLING '00'



BOISERIE '80'
PANNELLING '80'



IMPIANTO PER LUCI LEDI INFERIORE O SUPERIORE
ALLA PANNELLATURA
LIGHTING PLANT TOP OR BOTTOM OF A PANEL

CONTENITORI BASE
BASE CONTAINERS



ANTA PROFILO '00'
PROFILE '00' DOOR



CONTENITORI MAGGIE DI VETRO
CONTAINERS MAGGIE WITH GLASS





COMPOSIZIONE CON PANNELLI BOISERIE SP. '80' E CONTENITORI SOSPESI, MENSOLE SP. '38' E SP. '80' E MENSOLE IN ALLUMINIO.

COMPOSITION WITH PANELLING BOISERIE TH.80 AND HANGING CONTAINERS, SHELVES TH. 38 AND 80 AND SHELVES IN ALUMINUM.



COMPOSIZIONE CON BOISERIE SOSPESA '00', CONTENITORI PENSILI, MENSOLE IN ALLUMINIO, PANNELLO TV E PANCA A TERRA.

COMPOSITION WITH HANGING PANELLING BOISERIE '00', HANGING CONTAINERS, SHELVES IN ALUMINUM, TV PANEL AND FLOOR BENCH.



PRECISIONE COMPOSITIVA E CURA PER I DETTAGLI DEFINISCONO LE SOLUZIONI MISURAEEMME. UN APPROCCIO PRODUTTIVO ISPIRATO ALLE NECESSITÀ DELL'ABITARE CONTEMPORANEO IN CUI L'ECCELLENZA MADE IN ITALY SI DECLINA IN UNA PROGETTUALITÀ TRASVERSALE CAPACE DI FORGIARE PROPOSTE GLAMOUR E FUNZIONALI ALLO STESSO TEMPO.

COMPOSITIONAL PRECISION AND ATTENTION TO THE FINEST OF DETAILS DEFINE MISURAEEMME COMPOSITIONS. A PRODUCTION APPROACH INSPIRED BY CONTEMPORARY LIVING NECESSITIES, WHERE MADE IN ITALY EXCELLENCE IS EXPRESSED THROUGH TRANSVERSE PROJECT DEVELOPMENT PROCESSES CAPABLE OF FORGING GLAMOROUS YET FUNCTIONAL SOLUTIONS.



COMPOSIZIONE CON BOISERIE '00', CONTENITORI SOSPESI E A TERRA, MENSOLE IN ALLUMINIO A 'L' E PANCA A TERRA.

COMPOSITION WITH PANELLING BOISERIE '00', HANGING AND FLOOR BASED CONTAINERS, "L" SHELVES IN ALUMINUM, TV PANEL AND FLOOR BENCH.



COMPOSIZIONE CON BOISERIE '00', CONTENITORI SOSPESI E A TERRA, MENSOLE SP. '80' E MENSOLE IN ALLUMINIO.

COMPOSITION WITH PANNELLING BOISERIE '00', HANGING AND FLOOR BASED CONTAINERS, SHELVES TH.80 AND SHELVES IN ALUMINUM.

UN DESIGN LINEARE ESALTATO DALL'ACCOSTAMENTO DI MATERIALI DIVERSI. LA NOBILE VENATURA DEL LEGNO INCONTRA L'ESSENZIALE LEGGEREZZA DEL METALLO IN UN SISTEMA GIORNO DALLA SPICCATATA PERSONALITÀ.

A LINEAR DESIGN ENHANCED BY THE MATCHING OF DIFFERENT MATERIALS. THE NOBLE VEINING OF WOOD MEETS THE ESSENTIAL LIGHTNESS OF METAL IN A LIVING AREA SYSTEM BRIMMING WITH PERSONALITY.





COMPOSIZIONE CON PANCA A TERRA, CONTENITORI SOSPESI E A TERRA, MENSOLE IN ALLUMINIO.

COMPOSITION WITH FLOOR BENCH, HANGING AND FLOOR BASED CONTAINERS, SHELVES IN ALUMINUM.



COMPOSIZIONE CON CONTENITORI SOSPESI DESTRUTTURATI E CONTENITORI A CASSETTONI A TERRA.

COMPOSITION WITH HANGING DESTRUCTURED CONTAINERS AND FLOOR BASED CONTAINERS WITH BIG DRAWERS.



COMPOSIZIONE CON CONTENITORI SOSPESI E CONTENITORI CON CASSETTI A TERRA E SCRITTOIO SP. '80'.

COMPOSITION WITH HANGING AND FLOOR BASED CONTAINERS WITH DRAWERS, WRITING DESK TH.80.

TAO

MODULARITÀ / MODULARITY

Anta battente - ribalta up - ribalta down - cassetto
Hinged door - flap door up - flap door down - drawer



Anta battente - ribalta down - cassetto
Hinged door - flap door down - drawer



Anta battente - ribalta up
Hinged door - flap door up



Contentori Maggie a giorno, con cassetti e in vetro / prof. 304 mm - H. 326 mm
Containers Maggie with drawers and glass / D. 304 mm - H. 326 mm



L. 320 mm L. 640 mm.



L. 320 mm L. 640 mm.

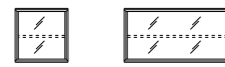

L. 320 mm L. 640 mm.



L. 320 mm L. 640 mm.

Mensole alluminio a L
Aluminium shelves 'L'

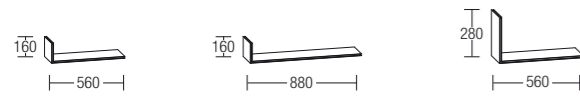

Mensole - panche a terra - piani top sp. 80mm / prof. 300 - 436 - 516 mm
Shelves - floor bench - top Th. 80mm. / D. 300 - 436 - 516 mm

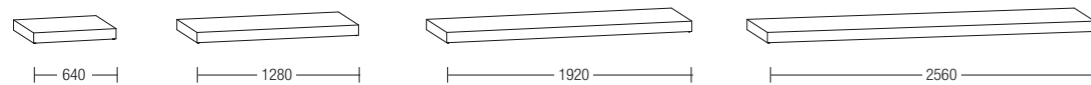

Mensole sp.38mm prof. 304 - 380 mm / Shelves Th. 38mm. D. 304 - 380 mm

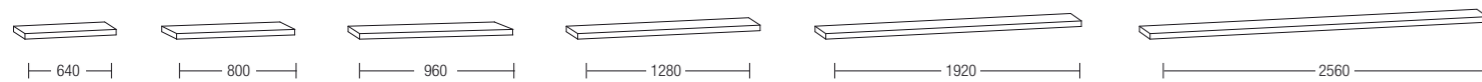

Mensole alluminio con e senza luci LED Zaffiro prof. 213 mm / Aluminium shelves with or without LED Zaffiro D. 213 mm

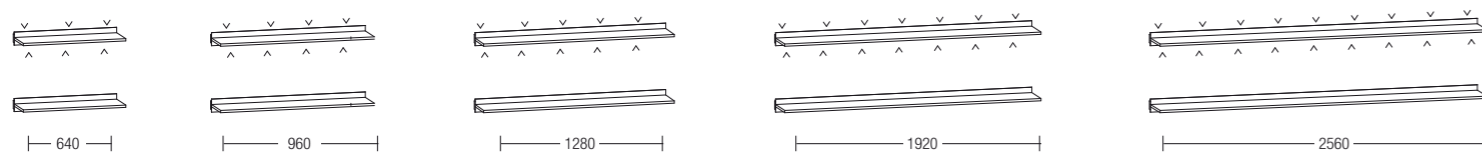

Contentori base e pensili, standard e TV P. 384 mm - P. 490 mm / Base containers and hanging containers, standard and TV D. 384 mm - D. 490 mm
Contentori base, standard e TV - P. 490 mm / Base containers, standard and TV - D. 490 mm

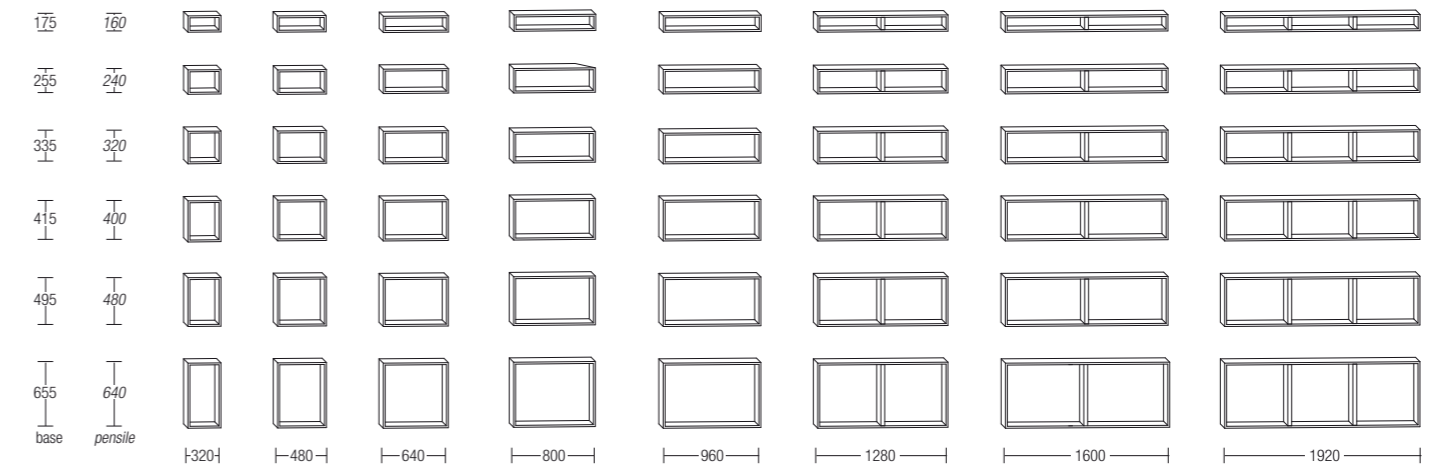

Contentori base e pensili, standard e TV P. 384 mm - P. 490 mm / Base containers and hanging containers, standard and TV D. 384 mm - D. 490 mm

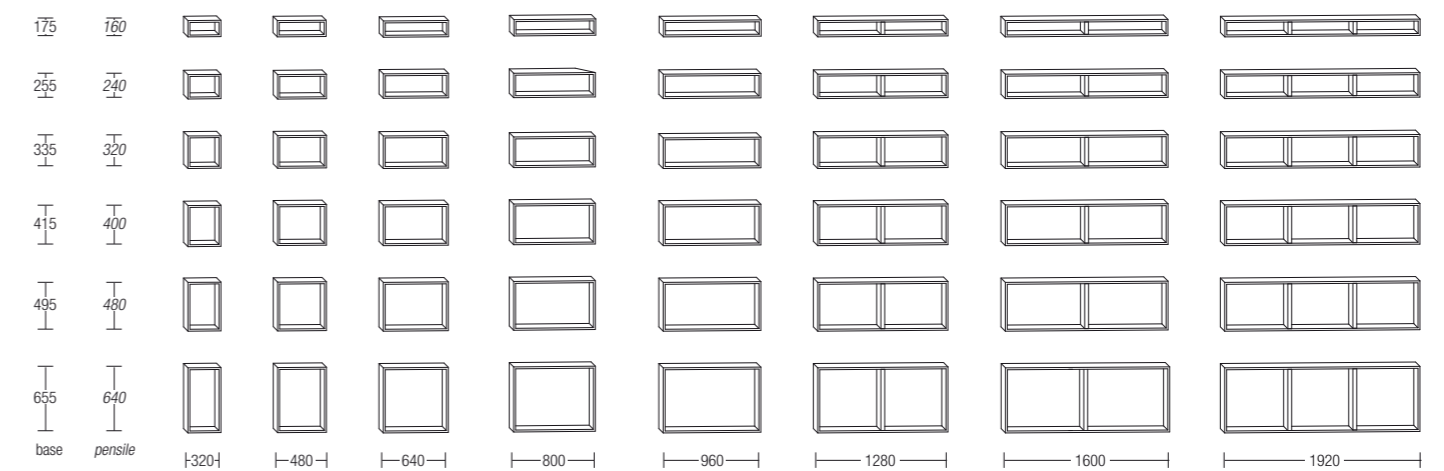

Contentori base e pensili, standard P. 384 - P. 490 mm / Base containers and hanging containers, standard D. 384 mm - D. 490 mm

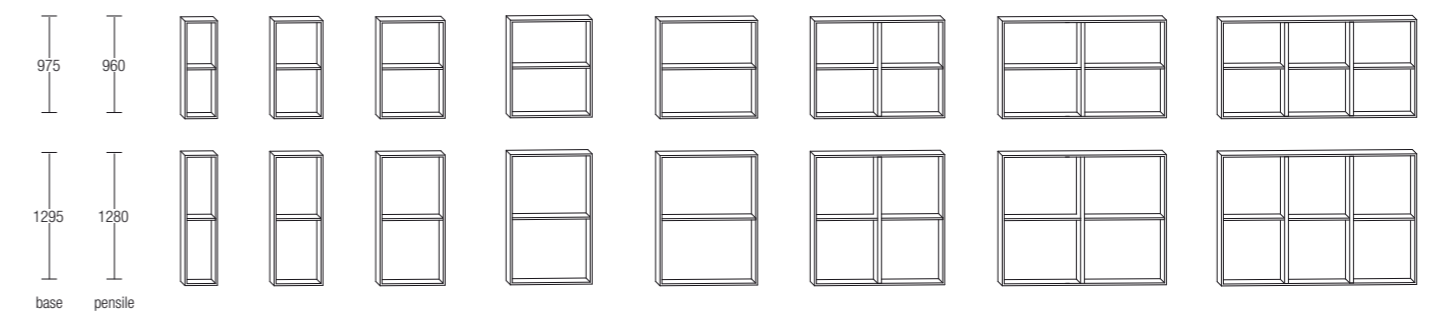

Contentori base standard P. 490 mm / Base containers standard D. 490 mm

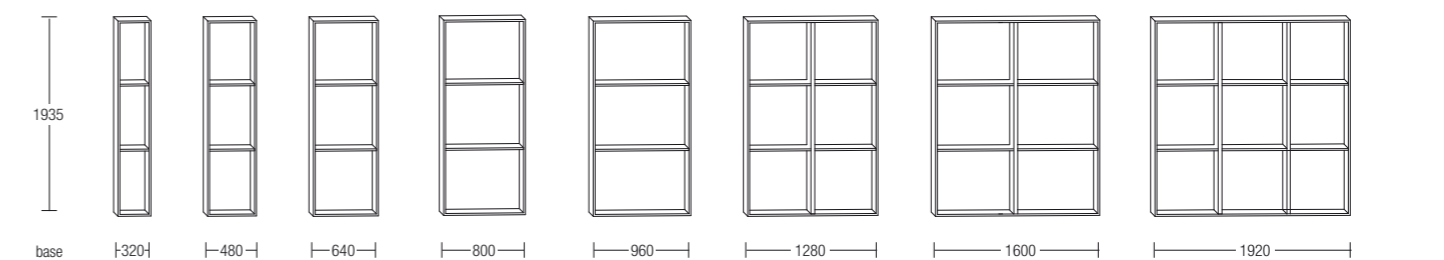

CROSSING

ELEMENTI COSTITUTIVI / COMBINED ELEMENTS

BIFACCIALE
DOUBLE SIDE



RIPIANI AD ANGOLO
CORNER SHELVES



SPALLE SOSPESSE A MURO
HANGING SIDE PANELS



ANTE TEKA
TEKA DOORS



SPALLE SOSPESSE DESTRUTTURATE
HANGING DESTRUCTURED SIDE PANELS



TEKE



BOISERIE TECNO-MARBLE



RASTER



INTEGRAZIONE CONTENITORE
INSERTED CONTAINERS



PALO ALTO DAY E TEKE
PALO ALTO DAY AND TEKE



ANTA RIBALTA BAR
'BAR' FLAP DOWN DOOR

ANTE VETRO SCORREVOLI
SLIDING GLASS DOORS



ANTE BATTENTI
HINGED DOORS



COMPOSIZIONE CON SCRITTOIO
COMPOSITION WITH WRITING DESK





COMPOSIZIONE A LIBRERIA SPALLE A TERRA CON CONTENITORI CHE SI COMPENETRANO.

BOOKSHELF COMPOSITION WITH BASE SIDE PANELS AND CONTAINERS.



COMPOSIZIONE A LIBRERIA CON SPALLE SOSPESSE E A TERRA, PANNELLO TV CON ANTE VETRO SCORREVOLI.

BOOKSHELF COMPOSITION WITH HANGING AND BASE SIDE PANELS, TV PANEL WITH SLIDING GLASS DOORS.



UNA VERA INNOVAZIONE REINVENTA IL CONCETTO LIBRERIA. I PANNELLI CHE LA COMPONGONO, LIBERANDOSI DAL LORO PESO, CONSENTONO ALLE SCAFFALATURE DI POTER ESSERE SOSPESSE, DANDO UN NUOVISSIMO SENSO DI "LEGGEREZZA VISIVA". IL NOSTRO CENTRO RICERCHE HA INDIVIDUATO UN MATERIALE DOTATO DI MASSIMA STABILITÀ E INDISCUTIBILE LEGGEREZZA: UN LISTELLARE DI PIOPPA A 3 STRATI TRA DI LORO INCROCIATI, PLACCATO TRA DUE STRATI DI MDF E IMPIALLACCIATO.

A REAL INNOVATION REFRESHES THE CONCEPT OF BOOKCASES. THE PANELS OF WHICH IT CONSISTS, WITH LESS WEIGHT, ALLOW THE BOOKCASE TO BE HANGING GIVING A VERY NEW SENSE OF "VISIBLE LIGHTNESS". OUR RESEARCH CENTRE HAS FOUND A MATERIAL OF HIGH STABILITY AND UNDENIABLE LIGHTNESS: THREE CROSSING LAYERS OF SOLID POPLAR WOOD IN BETWEEN TWO LAYERS OF MDF AND VENEERED.



COMPOSIZIONE A LIBRERIA CON SPALLE SOPPESE E A TERRA IN VERSIONE DESTRUTTURATA.

BOOKSHELF COMPOSITION WITH HANGING AND BASE SIDE PANELS, DESTRUCTURED VERSION.



COMPOSIZIONE A LIBRERIA CON SPALLE SOSPESI E CONTENITORI SOSPESI, PANNELLO TV, BOISERIE SP. '80' CON MENSOLE IN ALLUMINIO.

BOOKSHELF COMPOSITION WITH HANGING SIDE PANELS AND CONTAINERS, TV PANEL, PANNELLING BOISERIE TH. '80' WITH SHELVES IN ALUMINUM.



COMPOSIZIONE A LIBRERIA CON SCRITTOIO INTEGRATO.

BOOKSHELF COMPOSITION WITH WRITING DESK.

LA RISPOSTA ALLE NUOVE ESIGENZE DELLA TECNOLOGIA DEI FLAT TV. ESSENDO SEMPRE PIÙ RIDOTTE LE PROFONDITÀ DEGLI SCHERMI E DELLE APPARECCHIATURE, ANCHE LE PROFONDITÀ DELLE SPALLE, SOPRATTUTTO I VANI INTERNI, DIVENTANO MENO PROFONDI PER ALLOGGIAMENTI PIÙ FUNZIONALI ED ESTETICAMENTE PIÙ CORRETTI RISPETTO AI PRECEDENTI PORTALI.

THE REPLY TO THE NEW REQUIREMENTS OF FLAT SCREEN TV TECHNOLOGY. AS THE DEPTHS OF THE SCREENS AND EQUIPMENTS ARE GETTING SLIMMER AND SLIMMER, ALSO THE DEPTH OF SIDE PANELS AND ESPECIALLY THE INTERNAL SPACES HAVE BEEN DECREASED AS WELL, TO CREATE A MORE FUNCTIONAL AND AESTHETICAL SURROUNDING.





COMPOSIZIONE A LIBRERIA CON SPALLE SOSPESSE E A TERRA, CONTENITORI SOSPESI.

BOOKSHELF COMPOSITION WITH HANGING AND BASE SIDE PANELS, HANGING CONTAINERS.



COMPOSIZIONE A LIBRERIA AD ANGOLO CON SPALLE SOPPESE E PANCA A TERRA.

CORNER BOOKSHELF COMPOSITION WITH HANGING SIDE PANELS AND FLOOR BENCH.



IL PIOPPO È UN LEGNO ESTREMAMENTE LEGGERO, FACILMENTE LAVORABILE E DI AGEVOLE REPERIBILITÀ SUL TERRITORIO. UN LEGNO “POPOLARE” CHE NON IMPATTA NEGATIVAMENTE SULL’AMBIENTE GRAZIE AD UNA RICRESCITA PIÙ VELOCE DI ALTRE ESSENZE. UTILIZZANDO IL NUOVO MATERIALE SIAMO IN GRADO DI SOSPENDERE ANCHE LE SOLUZIONI ANGOLARI.

POPLAR WOOD IS AN EXTREMELY LIGHT TYPE OF WOOD, EASILY WORKABLE AND FOUND WITHOUT DIFFICULTIES ON THE MARKET. A “POPLAR” WOOD, WHICH HAS NO NEGATIVE IMPACT ON THE ENVIRONMENT AS IT GROWS QUICKER THAN OTHER TYPES OF WOOD. THANKS TO THIS NEW MATERIAL IT IS POSSIBLE TO CREATE HANGING CORNER ELEMENTS.



COMPOSIZIONE A LIBRERIA CON SPALLE SOSPese E MENSOLE SP. '80', BOISERIE '00' CON TV E CONTENITORE A TERRA CON CASSETTONI.

BOOKSHELF COMPOSITION WITH HANGING SIDE PANELS AND SHELF TH 80, TV PANELLING BOISERIE '00' AND FLOOR BASED CONTAINER WITH BIG DRAWERS.



COMPOSIZIONE A LIBRERIA DESTRUTTURATA CON SPALLE A TERRA BIFACCIALI.

DESTRUCTURED BOOKSHELF COMPOSITION WITH BASE SIDE PANELS, 2 SIDED.



COMPOSIZIONE A LIBRERIA CON SPALLE A TERRA, ANTA SCORREVOLE E ANTA BATTENTE IN VETRO.

BOOKSHELF COMPOSITION WITH BASE SIDE PANELS, SLIDING DOOR AND HINGED DOOR IN GLASS.

SE AGGIUNGIAMO ALLE CARATTERISTICHE CHE ABBIAMO GIÀ CITATO, IL FATTO CHE MISURAEMME UTILIZZA VERNICI ALL'ACQUA, IL NOSTRO SISTEMA DIVENTA UNO DEI "MOBILI PIÙ VERDI" IMMESSI SUL MERCATO.

ADDING TO THE PREVIOUS MENTIONED CHARACTERISTICS THE FACT THAT MISURAEMME USES WATER-SOLUBLE BASED VARNISH, OUR FURNITURE BECOMES ONE OF THE MOST "ENVIRONMENTALLY FRIENDLY" EVER PUT ON THE MARKET.





COMPOSIZIONE A LIBRERIA CON SPALLE SOSPESA A SCALARE E CONTENITORI SOSPESI.

BOOKSHELF COMPOSITION WITH CLIMBING HANGING SIDE PANELS AND HANGING CONTAINERS.



COMPOSIZIONE A LIBRERIA CON SPALLE SOSPese, ANTE A RIBALTA E CASSETTI.

BOOKSHELF COMPOSITION WITH HANGING SIDE PANELS, FLAP DOWN DOORS AND DRAWERS.

CROSSING

MODULARITÀ / MODULARITY

altezza per moduli a terra / heights for floor-based modules

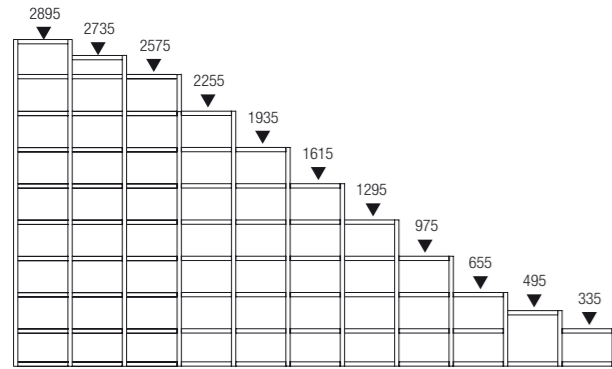

profondità / depth

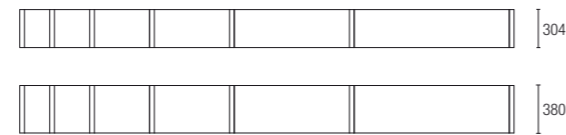

raster / raster

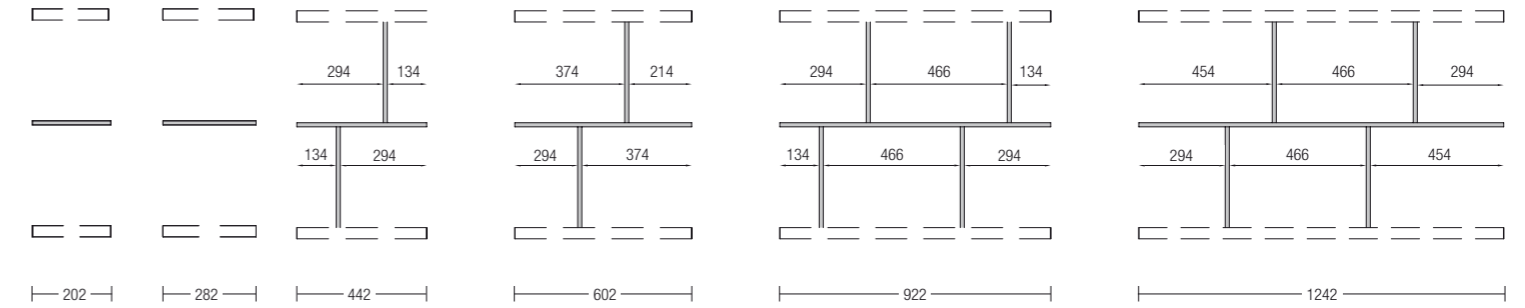

altezza per moduli sopraelevati su contenitori / heights for overhanging modules on containers

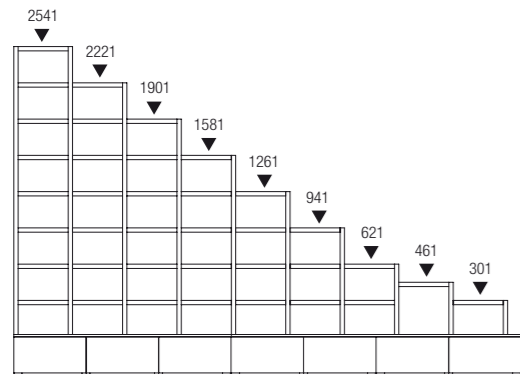

altezza per moduli pensili / heights for hanging modules

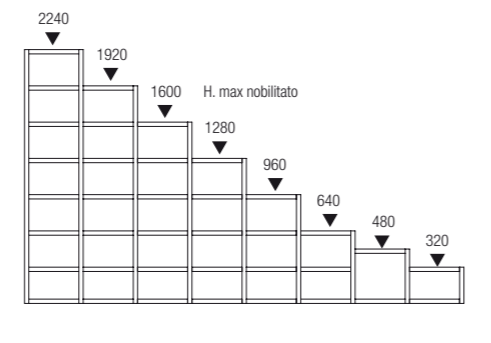

altezza vani / compartment height

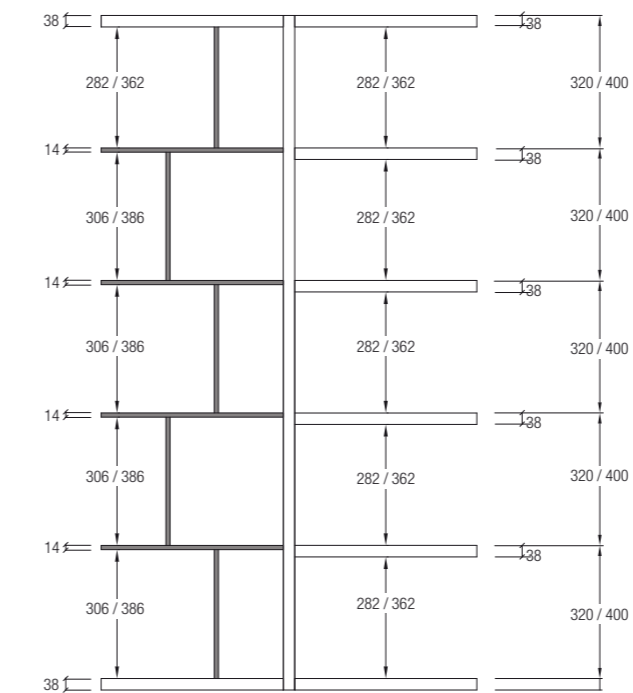

larghezza / width

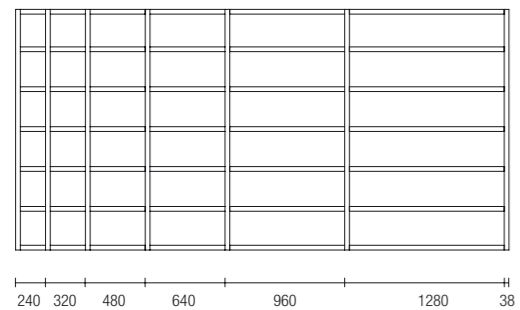

spalle da inserimento sp.38mm. / insertion panels Th. 38 mm

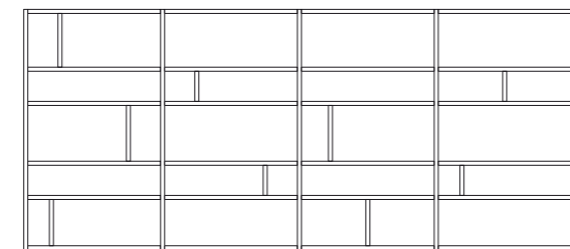

URBAN

ELEMENTI COSTITUTIVI / COMBINED ELEMENTS

CONTENITORI 'UP' E 'DOWN'
CONTAINERS 'UP' AND 'DOWN'



SCATOLE IN METALLO
METAL BOXES



SPALLETTE AD INSERIMENTO
SIDE PANELS TO BE INSERTED



MANIGLIE ANTE SCORREVOLI
HANDLES FOR SLIDING DOORS



BIFACCIALE
DOUBLE SIDE



ANTE SCORREVOLI DI VETRO
SLIDING GLASS DOOR



PANNELLO TV
TV PANEL



UNA GEOMETRIA D'INSIEME IN CUI RISALTANO I CONTRASTI MATERICI. LA LIBRERIA URBAN È UN CONNUBIO DI QUALITÀ ESTETICHE E CAPACITÀ FUNZIONALI, GRAZIE A UNA STRUTTURA LEGGERA IN LEGNO ARRICCHITA DA SCATOLE METALLICHE DAL GUSTO MINIMALE.

AN OVERALL GEOMETRY WHERE TACTILE CONTRASTS STAND OUT. URBAN BOOKCASE IS A TRIUMPH OF AESTHETIC QUALITY AND FUNCTIONAL CAPACITY, WITH A LIGHT WOODEN STRUCTURE ENRICHED BY METAL BOXES EXUDING MINIMAL FLAVOUR.



COMPOSIZIONE A LIBRERIA BIFACCIALE CON PIANI ORIZZONTALI DI GRANDI DIMENSIONI E SCATOLE IN METALLO.

2 SIDED BOOKSHELF COMPOSITION WITH HORIZONTAL LONG SHELVES AND METAL BOXES.



COMPOSIZIONE A LIBRERIA CON PIANI ORIZZONTALI DI GRANDI DIMENSIONI, SCATOLE IN METALLO, ANTE RIBALTA E PANNELLO TV.

BOOKSHELF COMPOSITION WITH HORIZONTAL LONG SHELVES, METAL BOXES, FLAP DOWN DOORS AND TV PANEL.



COMPOSIZIONE A LIBRERIA CON PIANI ORIZZONTALI DI GRANDI DIMENSIONI, SCATOLE IN METALLO, ANTE RIBALTA E PANNELLO TV.

BOOKSHELF COMPOSITION WITH HORIZONTAL LONG SHELVES, METAL BOXES, FLAP DOWN DOORS AND TV PANEL.



COMPOSIZIONE A LIBRERIA BIFACCIALE CON PIANI ORIZZONTALI DI GRANDI DIMENSIONI, SCATOLE IN METALLO, ANTE RIBALTA.

2 SIDED BOOKSHELF COMPOSITION WITH HORIZONTAL LONG SHELVES, METAL BOXES, FLAP DOWN DOORS.

PROPORZIONI EQUILIBRATE E LINEE NITIDE SI ESPRIMONO ATTRAVERSO CONTENITORI A RIBALTA ALTERNATI A RIPIANI A GIORNO. UNA CIFRA PROGETTUALE INEQUIVOCABILE DALL'ALLURE CONTEMPORANEA.

WELL-BALANCED PROPORTIONS AND CLEAR LINES ARE EXPRESSED THROUGH DROP FRONT CONTAINERS ALTERNATED WITH OPEN-FRONTED SHELVES. AN UNEQUIVOCAL PROJECT STYLE EXUDING CONTEMPORARY ALLURE.



URBAN

MODULARITÀ / MODULARITY

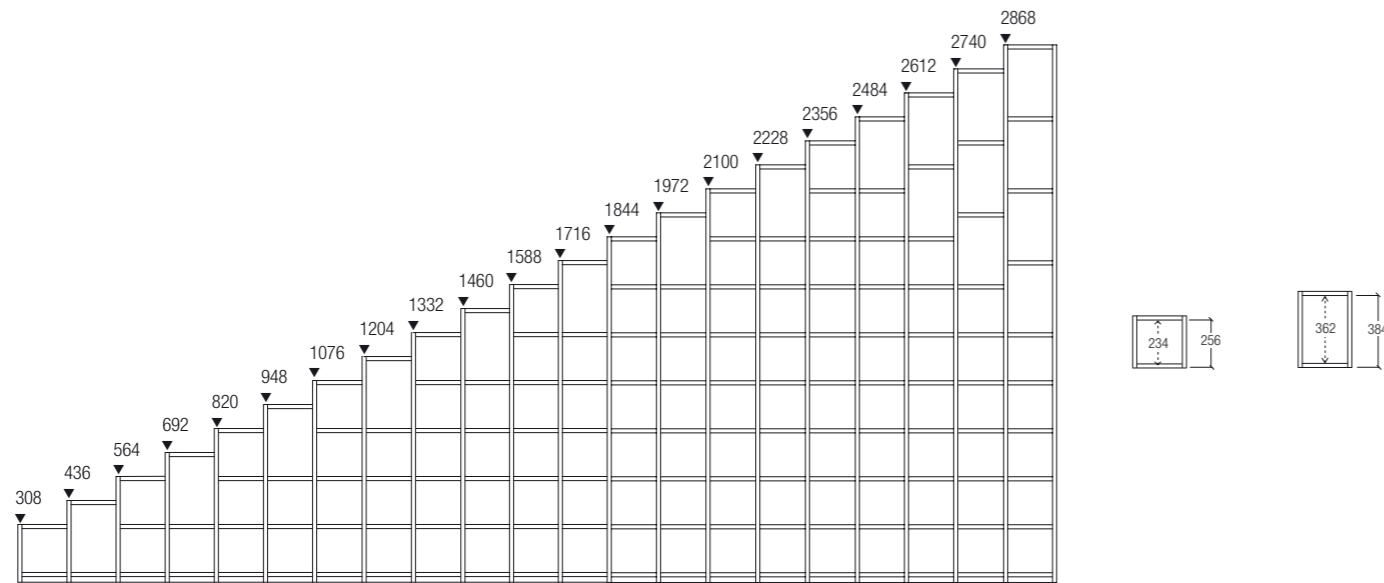

Contenitore frontale a "FILO LIBRERIA": anta ribalta down e cassetto
Container with front "FLUSH TO THE BOOKCASE": flap down and drawer

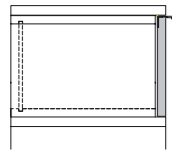

Contenitore frontale "BATTUTA 3 LATI": anta ribalta down - cassetto (no push)
Container with front "WITH DOOR STOP ON 3 SIDES": flap down and drawer (no push)

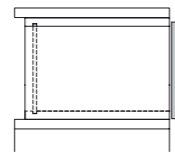

SCHEMA DI UTILIZZO CONTENITORI CON ANTE SCORREVOLI / DIAGRAM ON THE USE OF CONTAINERS WITH SLIDING DOORS

Contenitore con frontale "A FILO LIBRERIA"
Container with front panel "ALIGNED TO THE BOOKCASE"

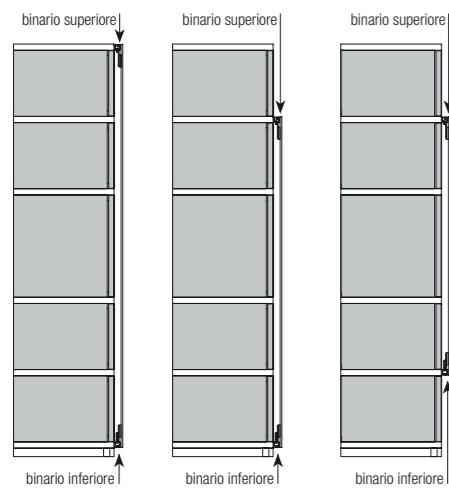

Contenitore avanzato per frontale "CON BATTUTA 3 LATI"
Container with external front "WITH REBATE ON 3 SIDES"

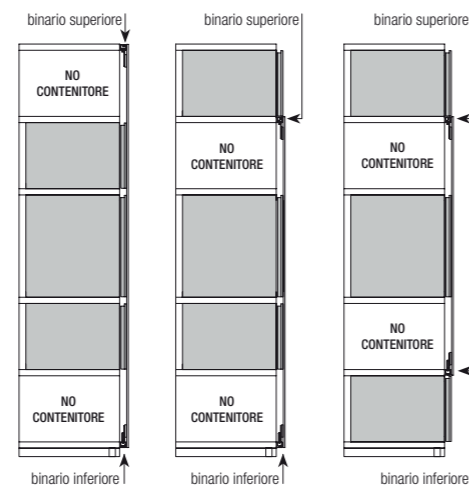

Griglia di sistema / Grid system

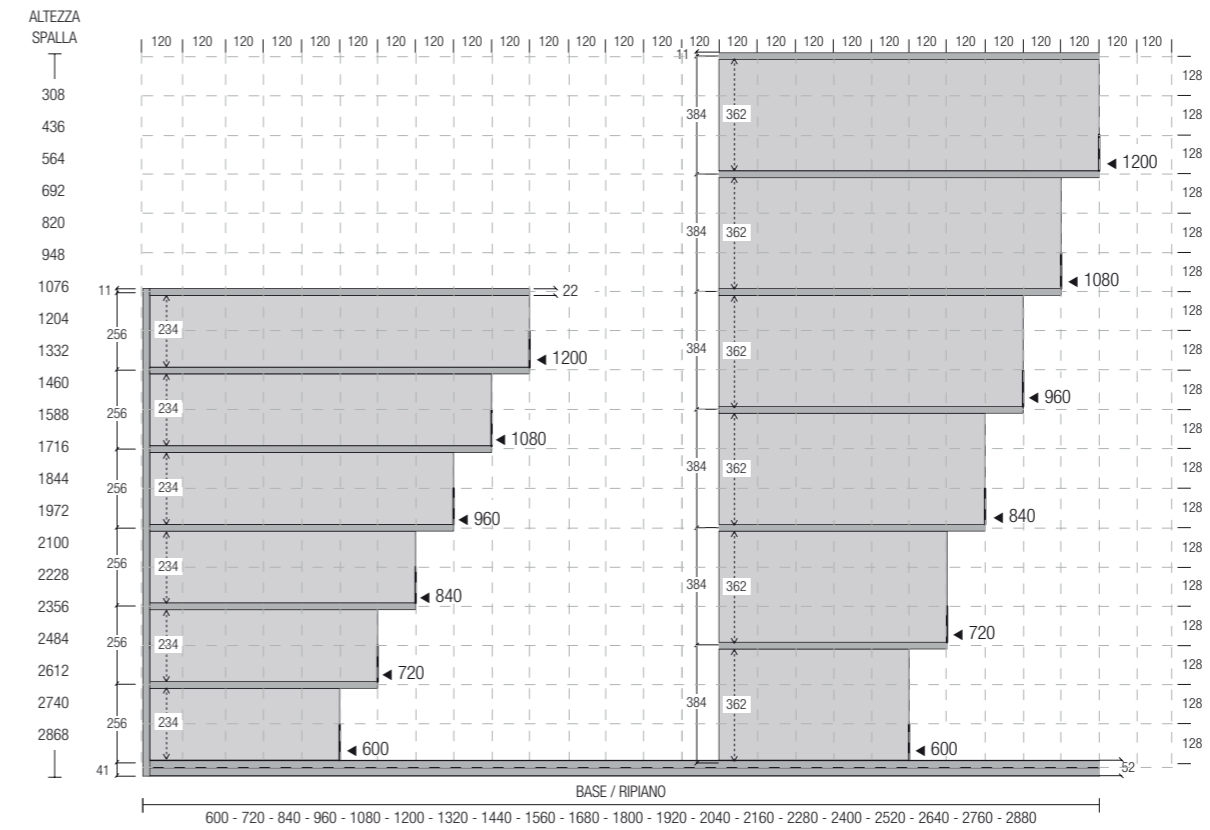

REGOLE DI COMPONIBILITÀ / COMPOSITION RULES

Posizionamento scatole e spallette per l'inserimento in griglia / Examples of use, of how the boxes and risers must be "placed" to be entered in the grid

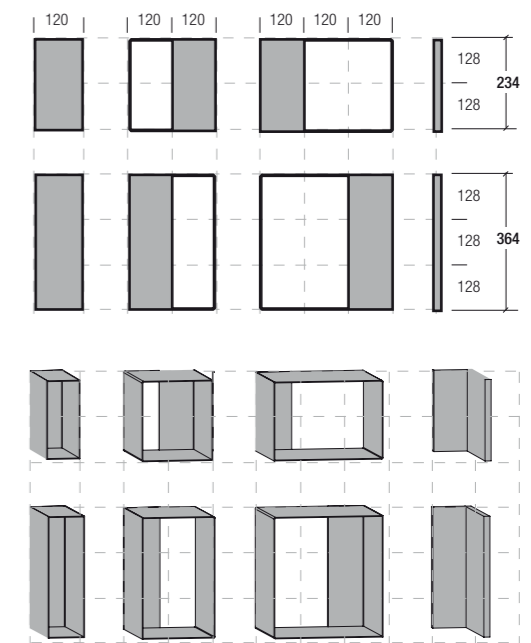
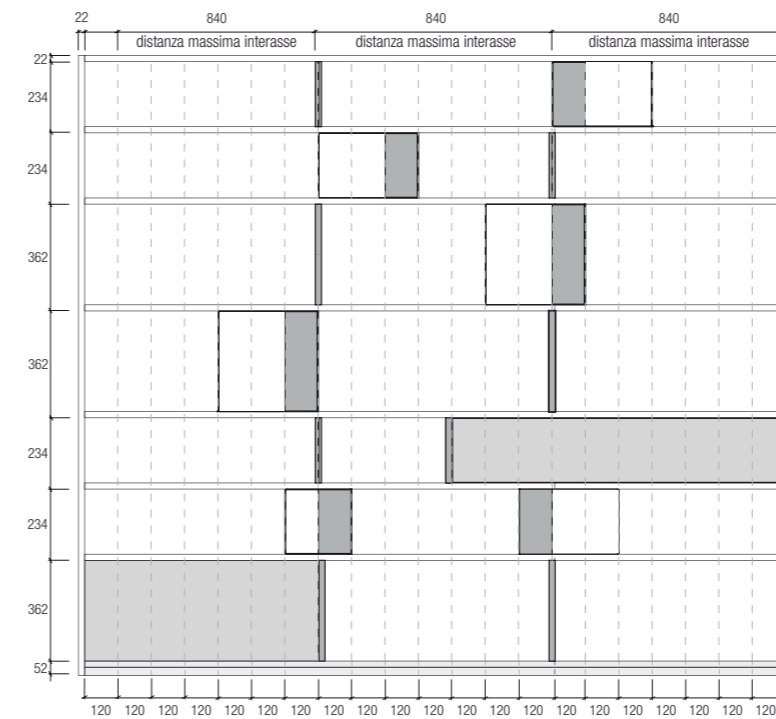





















MATERIALS

FINISHINGS . OUR VALUES

FINITURE

FINISHINGS

MisuraEmme® offre un'ampia gamma di finiture per creare sempre differenti soluzioni:

5 essenze che interpretano la verità stilistica del legno / 37 laccature di laccati opachi e lucidi, grazie alla nuova tecnologia di verniciatura all'acqua / 37 colori di vetri verniciati e di vetri verniciati acidati / 13 nobilitati sintesi delle più avanzate ricerche tecnologiche.

MisuraEmme® offers a wide range of finishings to create always different solutions:

5 wood veneer types to express the realism of wood / 37 colors matt or glossy lacquered, thanks to the new water-based lacquering technology / 37 colors are available for varnished or varnished and frosted glasses / 13 melamine finishes obtained from the synthesis of the most technologically advanced research.

COLORI LACCATI OPACHI E LUCIDI / MATT AND GLOSSY LACQUERED COLORS

VETRI VERNICIATI-VETRI ACIDATI VERNICIATI / VARNISHED GLASS-FROSTED VARNISHED GLASS

| | | | | |
|--------------|-------------|--------------------|------------------|----------------------|
| 02 TALCO | 9F SAND | 9G OSTRICA | 01 ALLUMINIO ▲ | 8W ANICE ▲ |
| 72 SABBIA | 8A BEIGE | 7B ROSA GIACINTO ▲ | 8C CAPPUCCINO | 8M LICHENE ▲ |
| 8B CAOLINO | 4G ARGILLA | 9T TOFFEE | 6B GRIGIO PIETRA | 8N OTTANIO ▲ |
| 8L GLICINE ▲ | 8I MALVA ▲ | 8H PRUGNA ▲ | 93 MELANGE | 9E DEEPBLU ▲ |
| 9A TERRA ▲ | 67 ROSSO ▲ | 81 FUOCO ▲ | 95 RUGGINE ▲ | 9H PETROLIO ▲ |
| 9B SENAPE ▲ | 7A FELCE ▲ | 13 SEPIA ▲ | 5B GRIGIO LAVA | 96 CANNA DI FUCILE ▲ |
| 8S GIALLO ▲ | 8P AZALEA ▲ | 8G IRIS ▲ | 8F FIORDO ▲ | 7D POLVERE ▲ |
| 01 GESSO | 14 NERO ▲ | LEGENDA / LEGEND | | |

vetro verniciato - prezzo fascia A / varnished glass - price category A
 vetro acidato - prezzo fascia C / frosted glass - price category C
 addebito del +15% / consider +15% surcharger ▲

NOBILITATI STRUTTURE / MELAMINE STRUCTURE

| | | | | |
|--------------------------------|-------------------------|--|------------------------------------|------------------------------------|
| 877 AMBIENCE AMBIENCE | 871 GREIGE GREIGE | 879 SHANTUNG DI SETA SILK SHANTUNG | 850 ROVERE CENERE OAK CENERE | 878 OLMO TRANCHE ELM TRANCHE |
| 852 ROVERE FUMÉ OAK FUMÉ | | | | |

ESSENZE / WOODS

| | | | | |
|----------------------|-----------------------------------|-------------------------------|--|-----------------------------|
| 49 NOCE WALNUT | 50 ROVERE CENERE OAK CENERE | 52 ROVERE FUMÉ OAK FUMÉ | 51 ROVERE TINTO NERO OAK STAINED BLACK | 53 OLMO GREY ELM GREY |
|----------------------|-----------------------------------|-------------------------------|--|-----------------------------|

NOBILITATI FACCIATE / MELAMINE DOORS

| | | | | |
|-----------------------------------|-----------------------------------|----------------------------------|------------------------------|-----------------------------------|
| 876 ROVIX GESSO ROVIX GESSO | ROVIX LACCATO U ROVIX LACQUER | 882 OLMO PALUDE ELM PALUDE | 881 OLMO GREY ELM GREY | 883 FUMÉ ROCK OAK FUMÉ ROCK |
| 88B CAOLINO CAOLINO | 85B GRIGIO LAVA GRIGIO LAVA | | | |

FINITURE

FINISHINGS

MisuraEmme® offre un'ampia gamma di finiture per creare sempre differenti soluzioni:
3 metalli / 3 vetri trasparenti / 3 vetri trasparenti acidati / 3 vetri riflettenti / 3 tipologie di specchi nella finitura lucida, acidata e temperata.
Infine MisuraEmme® propone 8 tipologie di marmo che arricchiscono e completano la gamma di finiture.

MisuraEmme® offers a wide range of finishings to create always different solutions:
3 metals / 3 transparent glasses / 3 transparent frosted glasses / 3 reflective glasses / 3 types of glossy, frosted and tempered mirrors /
8 types of marble enriches and complete the wide range of finishings.

METALLI / METALS

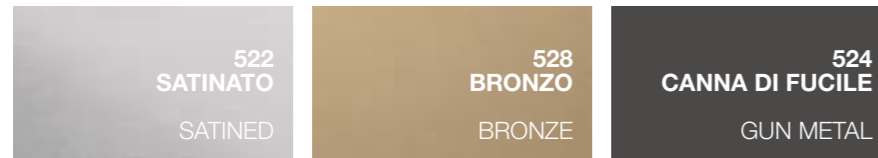

VETRI TRASPARENTI / TRANSPARENT GLASS

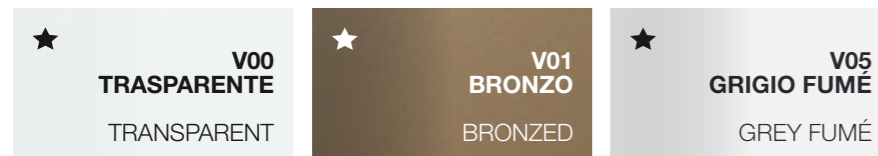

VETRI ACIDATI / FROSTED GLASS

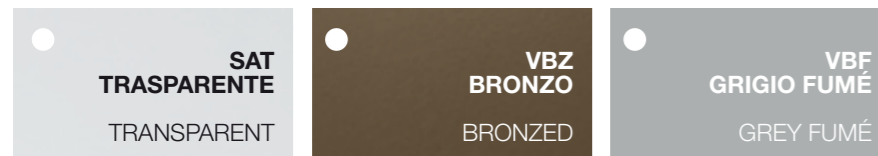

SPECCHI / MIRRORS

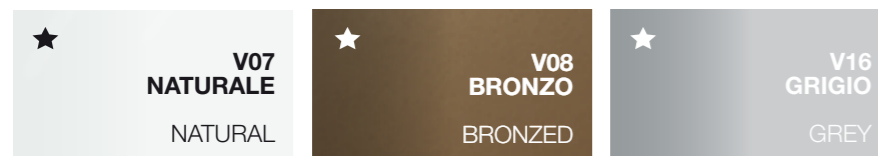

SPECCHI TEMPERATI / TEMPERED MIRRORS

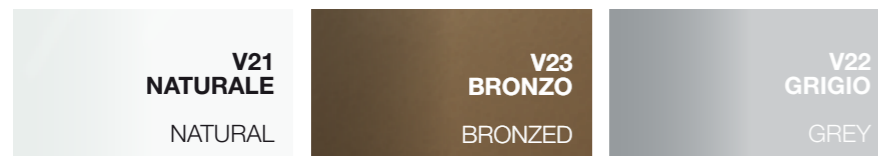

per applicazioni e prezzi consultare l'azienda / consult the company for applications and prices

VETRI RIFLETTENTI / REFLECTING GLASS

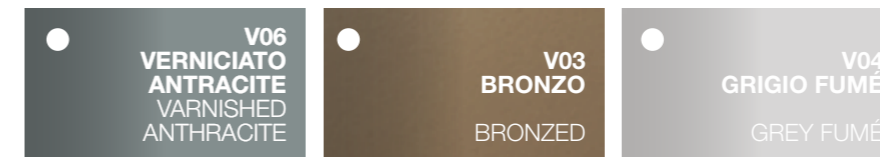

SPECCHI ACIDATI / FROSTED MIRROR

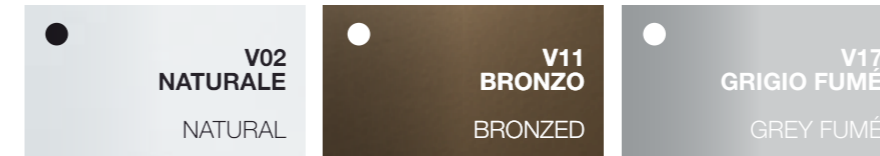

MARMI / MARBLES

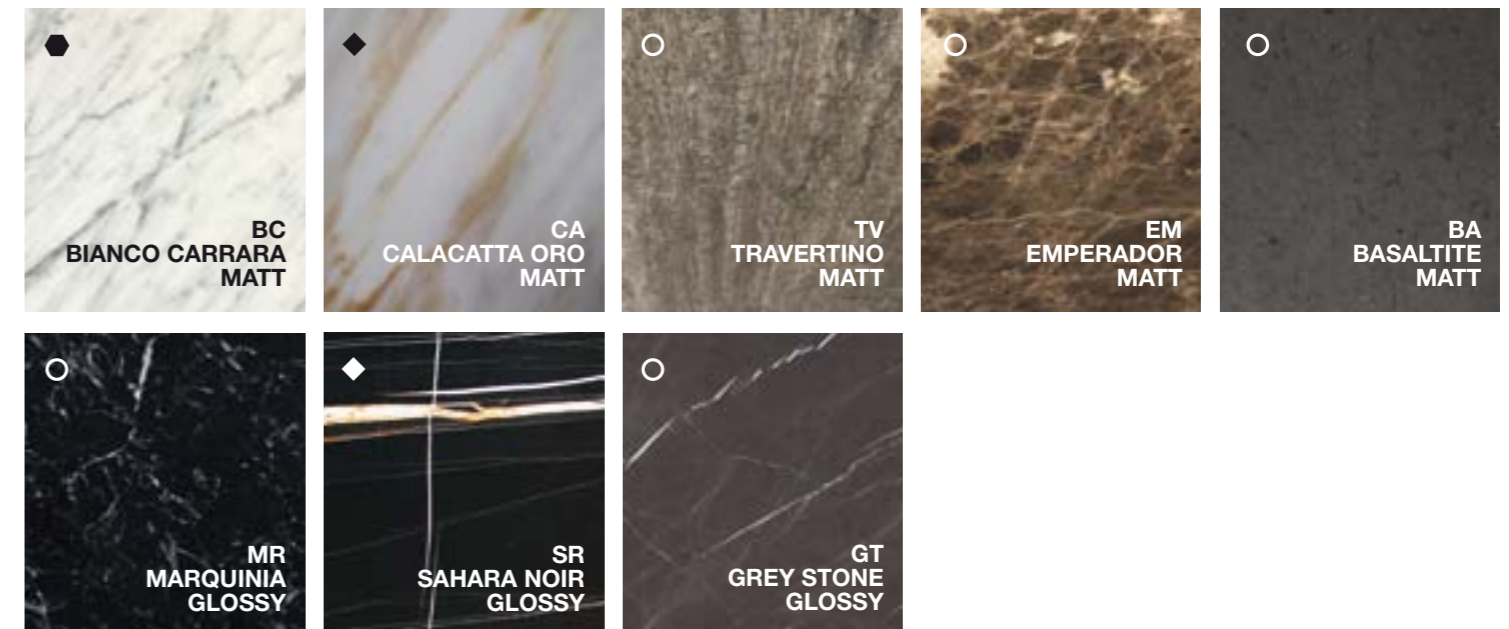

TECNOMARBLE



LEGENDA / LEGEND

- marmo M1 / marble M1
- marmo M2 / marble M2
- ◆ marmo M3 / marble M3

- ★ vetro prezzo fascia A / price glass category A
- vetro prezzo fascia C / price glass category C

I NOSTRI VALORI

OUR VALUES



UNA STORIA SENZA TEMPO

La storia di MisuraEmme ha inizio nei primi anni del secolo scorso, grazie a Giovanni il padre di Giuseppe e Luigi Mascheroni, il quale nel 1902 pose le basi del primo stabilimento dell'azienda a Mariano Comense, nel cuore del prolifico distretto brianzolo del mobile, conosciuto per la sua eccellenza manifatturiera. Oggi lo stabilimento ha una superficie di 35.000 mq. Trasmesso attraverso generazioni, il knowhow di MisuraEmme è l'esito di una sapienza consolidata nel tempo e fedele a valori forti e inderogabili. 100% Made in Italy, progettati da rinomati architetti e realizzati con cura artigianale da abili professionisti brianzoli, i prodotti MisuraEmme coniugano tradizione e avanguardia. L'azienda è in grado non solo di proporre linee di arredo caratterizzate da un alto tasso di personalizzazione e concepite one-to-one con il cliente, ma anche di esportare i suoi valori oltre i confini nazionali, ideando soluzioni in sintonia con i diversi contesti internazionali.

A TIMELESS STORY

The history of MisuraEmme started in the early years of the last century by Giovanni the father of Giuseppe and Luigi Mascheroni, who in 1902 founded the base of the company in Mariano Comense in the heart of the prolific district of furniture Brianza, well known for its excellent manufacturing. Today the establishment has a surface of 35.000 mq. Passed on by generations, the know-how of MisuraEmme is the result of consolidated knowledge over time and loyalty to strong and imperative values. 100% made in Italy, designed by famous architects and realised making use of the artisan culture of professionals of the Brianza area. The products of MisuraEmme embody the wish to combine tradition with innovation. Today the company is not only capable of proposing furniture characterised by a high level of personalisations and one-on-one designs with the client, but also to export these values, designing solutions in tune with different international requirements.

DETTAGLI CHE NON PASSANO INOSSERVATI

La cura per i dettagli è un imperativo di MisuraEmme. Essa si vince non solo dalla scelta di materiali di eccellente qualità - dal marmo di Carrara al legno massello di rovere, passando per i tessuti made in Italy o le pelli di provenienza europea - ma anche dal ricorso a lavorazioni speciali e di impronta artigianale che conferiscono un valore aggiunto ai complementi d'arredo. Tale accuratezza emerge, per esempio, nell'abile sagomatura dei piedi dei letti in massello di rovere; nelle pieghe eleganti e sinuose delle testate imbottite; nella preziosa fattura di maniglie che hanno la parvenza di un gioiello; nella minuziosa realizzazione di pezzi come lo storico e ineguagliabile carrello bar di Alfred Roth. E poi, ancora, nella speciale smussatura e bisellatura che rende i piani dei tavoli leggeri e raffinati; nella forma ergonomica e avvolgente delle sedute; nelle cuciture a vista dal sapore sartoriale; nella finitura interna di vani e cassetti; nelle luci LED a risparmio energetico allocate con cura e nell'ampia cartella colori.

EYE CATCHING DETAILS

Culture of details is culture of quality. This gives us the opportunity, in the world of contract, to be competitive in high level furnishing hotels preserving good value for money. Care for details is a must for MisuraEmme. This does not only show through the choice of first-class materials - from Carrara marble to solid oak wood, fabrics made in Italy to European leathers - but also customised processing and craftsmanship give added value to our products. Such high accuracy shows, for example, in the shaped solid oak feet of the beds: in the elegant and sinuous pleats of the padded headboard; preciously made handles that look like jewellery; in the storic and incomparable bar trolley of Alfred Roth. And then, again, the special chamfering that makes the table tops light and refined; the ergonomic shape of the seat; tailored visible stitches; the internal finish of units-drawers; in the energy saving LED lights and with ample colour chart.



C'È UNA TECNOLOGIA CHE NON INQUINA



Per MisuraEmme produttività e rispetto dell'ambiente sono concetti inscindibili. Grazie al forte investimento di risorse e lavoro, oggi l'azienda dispone di un rivoluzionario impianto di verniciatura all'acqua, che le ha consentito di ottenere per prima nel settore dell'arredamento il prestigioso marchio Aquaver® e nel 2014 il premio "GrandesignEtico". In virtù di questo innovativo sistema, i laccati opachi di MisuraEmme sono eco-friendly e atossici, valori spendibili nelle installazioni di Hotel per attrarre maggiormente una clientela sensibile ai problemi dell'inquinamento.

THERE IS A TECHNOLOGY THAT DOES NOT POLLUTE

For MisuraEmme productivity and respect for the environment are inseparable. Because of intense efforts both in time and resources, the company now disposes of a revolutionary water-soluble based lacquer system, for which it was awarded with the first prestigious mark Acquaver® and also in 2014 the "GrandesignEtico" International Awards. Thanks to this innovative system, the matt lacquer finishes of MisuraEmme are environmentally friendly and non-toxic, values to be spent by hotels to attract people particularly sensitive to pollution problems.

QUALITÀ CHE NON SI VEDONO

Gli arredi per gli Hotel sono sottoposti ad un intenso utilizzo, da qui la necessità di creare dei prodotti opportunamente studiati per resistere ad ogni tipo di usura. I prodotti MisuraEmme si distinguono non solo per l'alto valore estetico ma anche per l'elevata qualità progettuale e ingegneristica. Il sistema Crossing, con tripla anima in listellare di pioppo, il sistema a telaio (antiribaltamento) passacavi per l'aggancio dei pannelli TV e pensili o gli schienali avanzati ad incastro con i contenitori, che permettono il passaggio dei cablaggi a qualsiasi altezza siano sistemati, sono solo alcune delle virtù nascoste e altamente innovative progettate da MisuraEmme per adeguarsi alle moderne tecnologie.

HIDDEN QUALITIES

Hotel furnitures are subjected to an heavy-duty use, so we need to provide solutions and products studied to be long-lasting and which can with stand daily customer use. The products of MisuraEmme distinguish themselves not only through their high aesthetic value but also for the high quality of projecting and engineering. Crossing system, with three crossing layers of poplar blockboard, the hanging frame with cable-passage for fitting TV panels and hanging units to the wall (with roll over protection system) or the back panels placed between containers, that allow the passing of cables at any height, are only some of the hidden and highly innovative qualities designed by MisuraEmme to adapt to modern technologies.



CREDITS

Concept, art direction
MisuraEmme® studio

Photography
Michele Poli Mascheroni

Styling
Studio Rossella Battaglia
MisuraEmme® studio

Printing
Pigini Group Printing Division
Tecnostampa® Loreto – Trevi

Copyright
MisuraEmme®

Thanks to
ATIPICO
ARTEMIDE
ILLULIAN
KARMAN ITALIA
MAISON FIRE
NAHOOR Limelight
VENICEM
WISSENBACH

Made in Italy - OIBOAG

MisuraEmme® S.p.A.

Via IV Novembre, 72
22066 Mariano Comense (CO)
Tel. +39 031.754111
Fax. +39 031.744437
info@misuraemme.it
www.misuraemme.it

MisuraEmme® si riserva il diritto di apportare ogni modifica mirata al miglioramento funzionale e qualitativo dei propri prodotti.
Testi e disegni presenti in questo stampato hanno scopo divulgativo, per ogni aspetto tecnico e dimensionale fare riferimento ai listini aziendali e relativi aggiornamenti.

MisuraEmme® reserves the right at all time to apply modifications for the functional or qualitative improvement of its products. Text and drawings present in this brochure have a divulgative purpose, for every technical and dimensional aspect please refer to the company's price lists and their relative updatings.



The mark of
responsible forestry

Cerca prodotti certificati
FSC®



