



noken  
showers



## **showers** 2012

La gama para la ducha de Noken le ofrece una amplia variedad de productos, que gracias al poder del agua le permitirá disfrutar de placenteros momentos. Para cada situación, un producto específico; ¿sentir una experiencia sensorial en una cabina o una enérgica ducha que te aporte vitalidad? Noken le presenta una amplia gama de productos para cuidar de usted y de los suyos.

The Noken shower program offers you a wide variety of products, that will allow you to enjoy pleasant moments thanks to the revitalizing energy of water. For each situation, a specific product; whether you prefer a relaxing experience of the senses or a powerful shower that brings you vitality. Noken boasts a wide range of shower items to take care of you.



BY APPOINTMENT TO  
H.R.H. THE PRINCE OF WALES  
MANUFACTURER AND DISTRIBUTOR  
OF CERAMIC TILES AND BUILDING PRODUCTS.  
PORCELANOSA GROUP LIMITED

PORCELANOSA Grupo

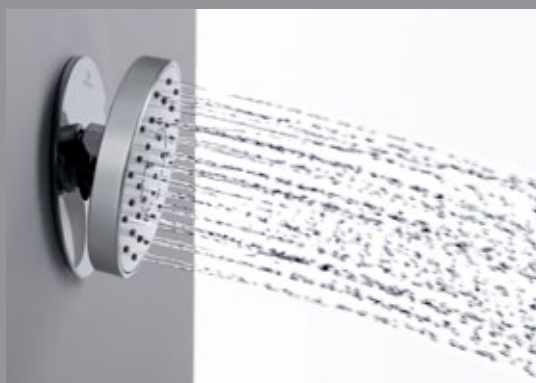

La ducha, como la entiende NOKEN, es un objeto de placer por las sensaciones que nos debe transmitir, tanto a nivel funcional como a nivel estético. La tecnología aplicada a la ducha, consigue duchas con múltiples funciones, capaces de seducir a los más exigentes, para buscar lo que necesitamos en cada momento del día, ducha relajante por la noche, ducha rápida por la mañana, masaje intenso para después de un esfuerzo... Todo ello acompañado por un desarrollo de materiales para combatir la cal y para el tan necesario, a día de hoy, ahorro del agua sin perder la satisfacción de una buena ducha.

The shower interpreted by NOKEN is a haven of pleasure because of the senses it transmits, both from a functional and aesthetic perception. The technology applied to the shower, presents showering with multiple functions, able to seduce the most demanding, to meet what you need in every moment of the day, a quick morning shower, a relaxing evening shower, or an intense massage shower after a difficult day... All these sensations are accompanied by technical aspects like the development of materials to beat lime-scale or energy-saving solutions that are fundamental nowadays, but without losing the essence of a satisfying shower experience.

# noken

---

**showers** 2012

---

SHOWER-CONCEPTS	10
essence-c	12
lounge	14
giro	16
soft	17
imagine-n	18
forma	19
ROCIADORES / SHOWER HEADS	20
essence-c	22
lounge	24
imagine-n	26
soft	27
giro	28
nk logic	32
urban	34
libra	36
programa neptune slim	38
programa encastrés	42
programa clásicos	44
programa brazos	46
JETS / BODY JETS	48
TERMOSTÁTICAS / THERMOSTATIC VALVES	54
TELEDUCHAS / SHOWER HANDSETS	60
PACKS DE DUCHA / SHOWER PACKAGES	74
COMPLEMENTOS / SHOWER ACCESSORIES	80
INSTALACIONES / INSTALLATIONS	82

MULTISPRAY

**LLUVIA:** El chorro más completo, que envuelve y acaricia el cuerpo.

**VAPOR:** Agua vaporizada que produce un efecto relajante sobre la piel, ideal para aliviar el cansancio muscular.

**MASAJE:** Una vigorosa modalidad de chorro, específica para estimular la piel.

**SOFT:** Para una ducha relajante. Combina el efecto vigorizante y el reparador.

**LLUVIA+VAPOR:** Un flujo constante con efecto refrescante y relajante.

**LLUVIA+MASAJE:** Un activo efecto masaje para una agradable ducha vigorizante.

**LLUVIA+SOFT:** Efecto con una caída de agua condensada en diferentes puntos que permite transportar la presión sobre una zona más amplia.

**SISTEMA ANTICAL:** Limpieza fácil para un chorro perfecto. Los depósitos de cal se eliminan fácilmente frotando con el dedo, lo que garantiza el buen funcionamiento y la conservación de los productos durante años.

**AIR ECO:** Mayor placer de ducha con la incorporación de aire en los chorros de agua. Se mezclan el agua y las burbujitas de aire (3 litros de aire por cada litro de agua). El resultado: millones de gotas de lluvia suaves y cálidas.

Más ahorro, más placer. Duchas y grifería que ahorran agua y energía.

**XXL:** El tamaño cuenta. Cabezales de ducha de gran tamaño para una experiencia de ducha única.

MULTISPRAY

**RAIN:** The complete water stream that covers and caresses our body.

**MIST:** vaporised water that produces an relaxing effect on the skin, ideal for relieving muscle fatigue.

**MASSAGE:** A vigorous form of body jet, specifically to stimulate the skin.

**SOFT:** For a relaxing shower. It combines the invigorating effect with skin repair.

**RAIN+MIST:** A steady water stream with refreshing and relaxing effect.

**RAIN+MASSAGE:** An active effect to a pleasant invigorating shower massage.

**RAIN+SOFT:** Shower effect with a stream of condensed water at different points that allows transporting the pressure over a wider area.

**ANTI-LIMESTONE:** Easy cleaning for a perfect stream. Lime deposits are removed easily by rubbing with your finger, ensuring the proper functioning and maintenance of the product for years.

**AIR ECO:** A greater shower pleasure because of the incorporation of air in the water spray. Mix water and air bubbles (3 litres of air per litre of water) and the result: is millions of soft, warm rain drops. More savings, more pleasure.

Showers and mixers to save water and energy.

**XXL:** Size counts. Heads of large for a single shower experience shower.

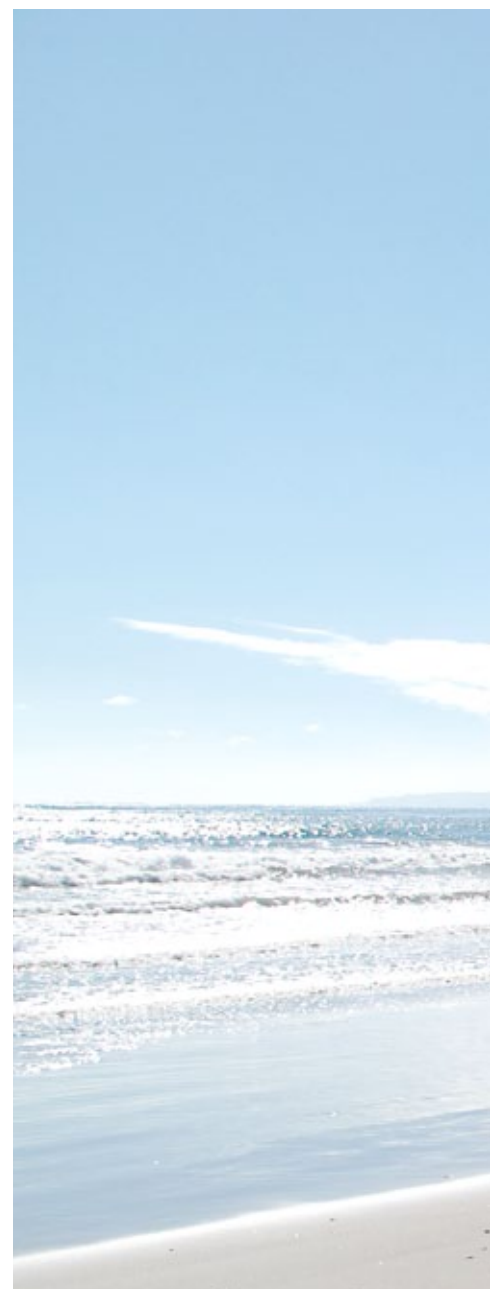

TOMA DE AGUA / SHOWER OUTLET ELBOW	FLEXIBLE / FLEXI SHOWER	BARRA DE DUCHA / SLIDE RAIL	TELEDUCHA / HANDSHOWER	DUCHA ORIENTABLE / ADJUSTABLE SPRAY	CASCADA / CASCADE	GRAN FORMATO / BIG SIZE FORMAT	AIR ECO	SISTEMA ANTICAL / ANTI-LIME	LLUVIA+SOFT / RAIN+SOFT	LLUVIA+MASAJE / RAIN+MASSAGE	LLUVIA+VAPOR / RAIN+MIST	SOFT / SOFT	MASAJE / MASSAGE	VAPOR / MIST	LLUVIA / RAIN	
						XXL	AIR ECO									ROCIADORES / SHOWER HEADS
						XXL	AIR ECO									JETS / BODY JETS
H <sub>2</sub> O						XXL	AIR ECO									TELEDUCHAS / HANDSHOWERS







Mejorar, renovar, perfeccionar, reinventar, innovar. En Noken somos inconformistas. Éste es el espíritu que nos lleva a imaginar los nuevos espacios de baño. Creados pensando en ti, como pequeños universos privados donde reponer tu cuerpo y tu espíritu del trepidante ritmo de vida que nos envuelve. El agua, las formas, los espacios y colores, los materiales y las soluciones, están estudiados para ayudarte a encontrar el relax o el estímulo, el descanso o la inspiración que necesitas para vivir el día a día. De la mano de los grandes diseñadores y arquitectos, Noken nos propone soluciones atrevidas e innovadoras, desarrolladas con los materiales y los componentes más avanzados, aplicados con última tecnología.

Noken te ayuda también a mantener tu compromiso con el medio ambiente ofreciéndote soluciones para que reduzcas el consumo de agua y energía. En Noken reinventamos, innovamos y perfeccionamos los espacios de baño para que tú puedas sentir.

Improve, renew, progress, reinvent, and innovate. Noken are non-conformists. This is the spirit which brings us to design new bathroom spaces. Creative thinking for small private universes where you replenish your body and your spirit of the fast pace of life that surrounds us. Water, forms, spaces and colours, materials and solutions, are studied to help you find relaxation or stimulation, rest or the inspiration you need to for everyday life. From the hand and mind of great designers and architects, Noken proposes bold and innovative, developed solutions with the materials and the most advanced components, applied with latest technology. Noken also helps you to maintain your commitment to the environment offering you solutions to reduce water and energy consumption. Noken reinvents, innovates and improves bathroom spaces so you can feel the sensations.

# CONCEPTOS DE DUCHA SHOWER CONCEPTS

Noken ha concebido Shower Concepts con productos diseñados para estimular y mejorar la arquitectura de el baño, dando gran importancia a la creación de entornos con una integridad visual estética de alto valor. La búsqueda de nuevos enfoques e interpretaciones para la configuración de salas de baño ha conducido a la creación de nuestro actual catálogo de ducha, una firme y prestigiosa declaración de diseño, combinando exquisito estilo con la más alta calidad. Las últimas creaciones de Noken han revolucionado concepciones tradicionales. Cada diseño es único debido a la expresión de los valores de la investigación, la creatividad y la funcionalidad.

Noken conceived Shower Concepts with products designed to stimulate and improve the bathroom architecture, giving great importance to the creation of bathroom environments with a high value visual aesthetic integrity. The search for new approaches and interpretations for bathroom configuration has led to the creation of our Shower Catalogue, a strong and prestigious design statement, combining exquisite style with the highest quality. The latest creations of Noken have revolutionized traditional conceptions. Each design is unique due to the expression of the values of research, creativity and functionality.





shower concepts  
**essence-c**









shower concepts  
**lounge**





shower concepts  
**giro**





shower concepts  
**soft**



shower concepts  
**imagine-n**



shower concepts  
**forma**





# ROCIADORES

## SHOWER HEADS

Sentir la suave caricia del agua de lluvia, el estimulante masaje que nos proporcionan los chorros de agua o el cálido abrazo con la que nos envuelve el agua nebulizada. Incluso puedes disfrutar de la nueva sensación AIR ECO, que ahorra en el consumo de agua. Todo un repertorio de emociones te aguardan al entrar en contacto con el agua, a través de las duchas, los jets y los rociadores Noken.

Feel the gentle touch of rainwater, stimulating massage provided by water sprays or the warm embrace that surrounds us with water mist function. You can even enjoy the new AIR ECO sensation, which saves water. A complete repertoire of sensations awaits you to come into contact with Noken body jets, hand showers and showers.







Conocer la fuerza natural del agua, el rociador Essence-c ofrece una experiencia especial en todos los aspectos. Panel de lluvia horizontal montado en pared, impresiona gracias a su imagen totalmente nueva. El tablero liso, montado a ras de la pared, destaca en el baño. Se crea una sensación de ducha totalmente nueva, con mucha libertad de movimiento gracias a los dos tipos de chorro. La ducha fija de 300 mm. ofrece una lluvia de ducha de dimensiones especialmente grandes. El amplio aluvión en cascada sale del panel como una catarata de agua. Placer de ducha extra para disfrutar de una forma totalmente diferente.

Experience the natural power of water, the Essence-c shower offers a special all-round experience. A horizontal shaped rain shower mounted on wall, impresses with its completely new image. The smooth shower head, mounted flanking the wall, really stands out in the bathroom. It creates a sense of a completely new shower, with freedom of movement because of the two types of water streams. The rain shower area of 300 mm offers a particularly shower. A spacious alluvial cascading drops out of the shower as a authentic waterfall of water. Extra shower pleasure to enjoy a totally different way.

ROCIADORES / SHOWER HEADS

# essence-c

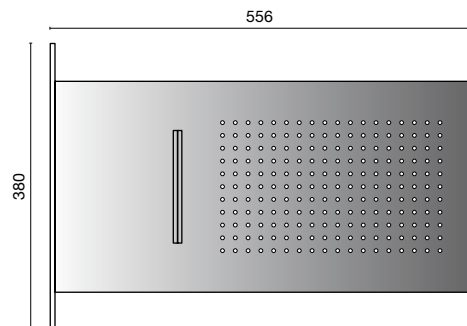

Rociador función lluvia + cascada con conexiones de 1/2".  
*Rain+cascade shower head with 1/2" connectors.*

espejo - mirror 100093583 - N183050311

Sentir el agua en toda su fuerza primitiva.

El modelo Lounge con doble función es en todos los sentidos una experiencia verdaderamente incomparable. La seducción de este panel de lluvia horizontal radica en su inédito diseño. Regálese con una sensación completamente nueva bajo la ducha, con total libertad de movimiento.

La ducha fija de 180 mm. con función lluvia le invita a experimentar una experiencia especialmente extensa o bien dejar que el singular y abundante salto de agua le infunda el poder de una maravillosa cascada. Mayor comodidad de uso: con la grifería adecuada de la colección Lounge el manejo es sumamente confortable. Los tipos de chorro se pueden regular cómodamente desde la pared.

Feel the water in all its primitive strength.

The Lounge shower with dual function is in every sense a truly seamless experience. The seduction of this horizontal rain shower lies in its unique design. Treat yourself with a completely new sensation under the shower, with total freedom of movement.

The fixed showerhead of 180 mm with rain function invites you to have a particularly extensive experience or either choose to enjoy the unique and abundant water cascade to feel the power of a wonderful waterfall. Greater ease of use: with the matching mixers from the Lounge series for extremely easy operation. The types of water stream can be regulated comfortably from the wall.





# lounge

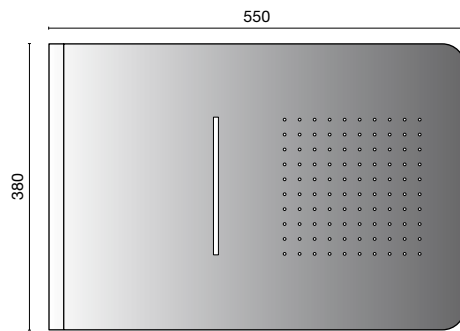

Rociador función lluvia + cascada con conexiones de 1/2".  
*Rain+cascade shower head with 1/2" connectors.*

espejo - mirror 100089933 - N199999811

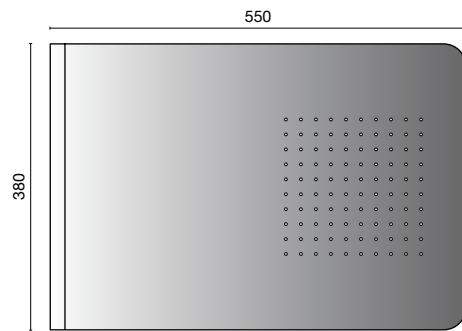

Rociador función lluvia con conexiones de 1/2".  
*Rain shower head with 1/2" connectors.*

espejo - mirror 100063526 - N199999988  
blanco - white 100082392 - N199999861

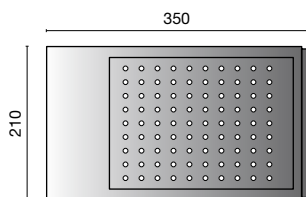

ROCIADORES / SHOWER HEADS

**imagine-n**

Rociador función lluvia + cascada con conexiones de 1/2".  
*Rain+cascade shower head with 1/2" connectors.*

chromo - chrome 100093584 - N169760039  
 oro - gold 100093585 - N169760040

ROCIADORES / SHOWER HEADS

**soft**

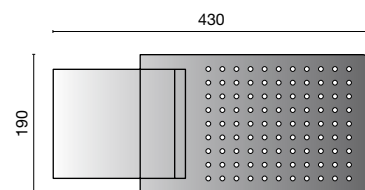

Rociador función lluvia + cascada con conexiones de 1/2".  
*Rain+cascade shower head with 1/2" connectors.*

chromo - chrome 100093586 - N196599506

Con el rociador Giro hemos reinventado la ducha. El diseño extraplano y el extraordinario rociador de doble función de ducha son los ingredientes de su éxito. Duchas fijas con 225 mm proporcionan un manto de lluvia fina que envuelve todo el cuerpo bajo la ducha. Una experiencia extraordinaria en su versión de doble salida, es el aluvión en cascada, que intensifica al máximo la ducha diaria, convirtiéndose en un festival de sensaciones para los sentidos.

With the GIRO model Noken has reinvented the shower. An Ultra-flat design and the extraordinary double function shower spray are the ingredients of its success. A fixed shower with 225 mm dimension provides a blanket of fine rain that wraps your body with water underneath the shower. Another amazing experience is the waterfall shower, which intensifies to the maximum extend your daily shower, becoming a gala of sensations for the senses.

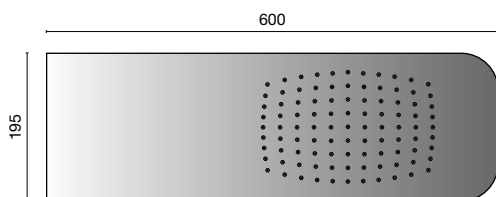

Rociador Cantos redondeados 60 cm.  
Round edge 60 cm rain shower head.

espejo - mirror 100089932 - N199999801

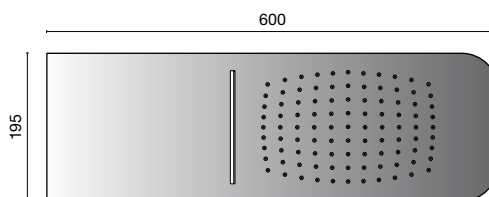

Rociador Cantos redondeados 60 cm. lluvia + cascada.  
Round edge 60 cm rain + cascade shower head.

espejo - mirror 100089931 - N199999802

ROCIADORES / SHOWER HEADS

**giro**



A mayor tamaño, mejor.

El tamaño de un rociador será proporcional al placer que se experimenta bajo la ducha. Así nace la idea de los rociadores XXL: cuanto mayor sea el disco de salida, mayor será la lluvia de ducha. Con un consumo equivalente de agua, se logra una distribución más eficaz del agua, envolviendo mejor el cuerpo. No sólo hemos ampliado las dimensiones de las teleduchas: también en rociadores se despunta hasta llegar a la imponente ducha de 500 mm, que sienta las bases de una categoría de producto enteramente nueva. Los rociadores Giro son amplios y redondos. Por un lado, se han adaptado a la pauta de los movimientos del ser humano, y es que incluso en la ducha, hay movimiento en juego. Y ya que el ser humano describe un círculo al rotar sobre sí mismo, Noken ha creado los rociadores Giro en forma circular.

The bigger, the better.

The size of a showerhead will be proportional to the pleasure experienced under the shower. This is how the idea to create Extra-Large showers found its way through: the bigger the shower rose, the greater will be the rain shower experience. A more effective water distribution is achieved with an equivalent water consumption, enveloping the entire body with water. We have not only expanded the dimensions of the hand showers, also in shower heads the variety of sizes grows up to an impressive shower of 500 mm, which lays the foundations of an entirely new product category. The Giro showers are large and round-shaped. On the one hand, they have adapted to the movement pattern of human being, where even in the shower, there is a pre-defined outline. And because human rely on a circle movement to rotate on its own, Noken created Giro showers with circular forms.

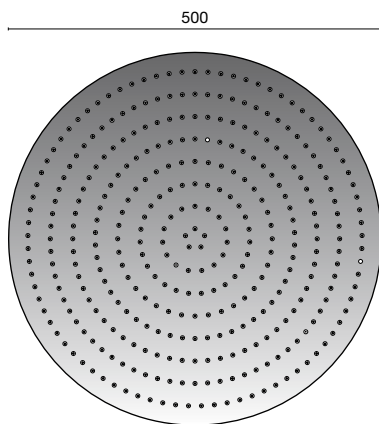

Rociador Rondo 50 cm., sin rótula.

*Rondo 50 cm rain shower head, without ball joint.*

espejo - mirror 100090441 - N199999807

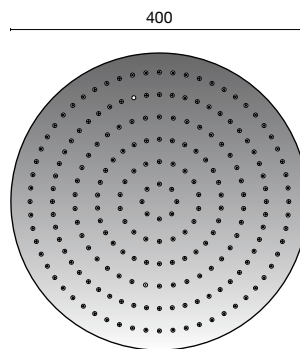

Rociador Rondo 40 cm., sin rótula.

*Rondo 40 cm rain shower head, without ball joint.*

espejo - mirror 100090133 - N199999806



ROCIADORES / SHOWER HEADS

**giro**

La nueva gama de rociadores NK Logic superará todo lo que conocía hasta ahora sobre la ducha. Ofrece una lluvia generosa; con su increíble tamaño de 500 mm, NK Logic es, ya por su estética, mucho más que un rociador normal, pese a su tamaño, su diseño se caracteriza por su reducido perfil de tan solo 3 mm, lo que convierte a esta gama de rociadores en un atractivo elemento arquitectónico. Y, una vez en acción, no hay quien la pare: agua por todas partes. La carga de la vida cotidiana desaparece, la vitalidad y la energía regresan y el cuerpo y el alma por fin encuentran su espacio.

The new range of NK Logic showers will surpass every shower experience known so far. It offers a generous rain shower; with its incredible size of 500 mm, NK Logic is only for its aesthetic, already much more than a normal showerhead. Despite its size, its design is characterized by its low profile of just 3 mm, which adds an attractive architectural element to this shower range. And, once in action, there is no stopping: enjoy water everywhere. The burden of everyday life disappears, the vitality and energy return and the body and soul at last found its space.

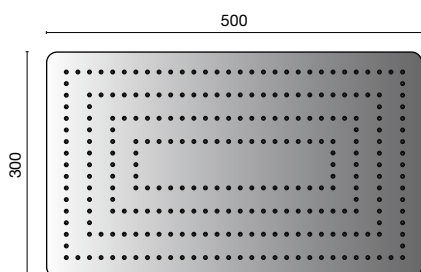

Rociador Recto 50x30 cm., sin rótula.

*Recto 50 x 30 cm rain shower head, without ball joint.*

espejo - mirror 100090135 - N199999803

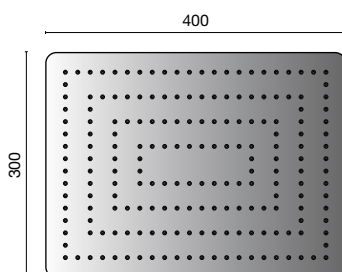

Rociador Recto 40x30 cm., sin rótula.

*Recto 40 x 30 cm rain shower head, without ball joint.*

espejo - mirror 100090134 - N199999809

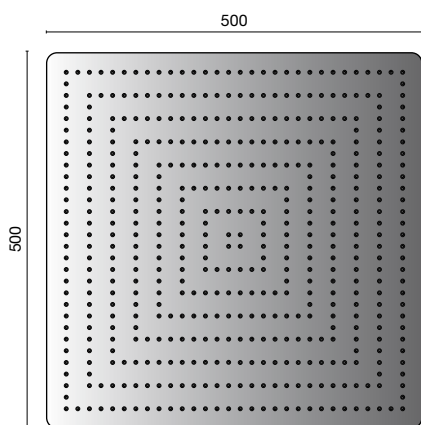

Rociador Square 50 cm., sin rótula.

*Square 50 cm rain shower head without ball joint.*

espejo - mirror 100090137 - N199999810

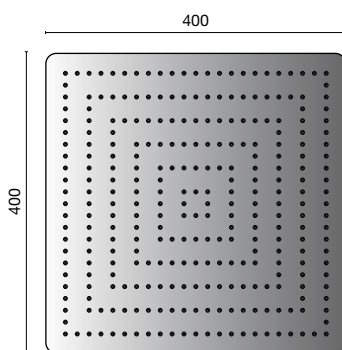

Rociador Square 40 cm., sin rótula.

*Square 40 cm rain shower head without ball joint.*

espejo - mirror 100090136 - N199999804





ROCIADORES / SHOWER HEADS

**nk logic**

# AIR ECO

## Tecnología AIR ECO

Agua + aire = lluvia natural

La lluvia natural es el modelo para el desarrollo de la innovadora tecnología AIR ECO de Noken. Y es que el agua sólo puede desplegar su efecto similar a la lluvia si corre en un movimiento circular libre, y al hacerlo absorbe suficiente aire, tal como ocurre en la naturaleza. Es en este principio natural en el que se basan las duchas AIR ECO de Noken: el aire se aspira en el cabezal de la ducha y se mezcla con el agua en una relación de 3:1, arremolinándose a continuación. Las burbujitas de aire en la ducha interrumpen los chorros formados por hilos de agua. Se generan así millones de grandes gotas de agua perladas, que además reproducen también el sonido característico de la lluvia natural.

## Technology AIR ECO

Water + air = natural rain

Natural rain was the mindset for the development of the innovative technology AIR ECO. And water can only deploy a similar effect to rain when it runs in a free circular motion and by doing so absorbing air, just like in nature. It is exactly in this principle of nature that Noken presents its AIR ECO showers: air is aspirated into the shower head and is mixed with water in a ratio of 3:1, to create a swirling effect. These air bubbles interrupt the solid water stream and generate millions of large water drops, which in addition also reproduce the sound of the natural rain.

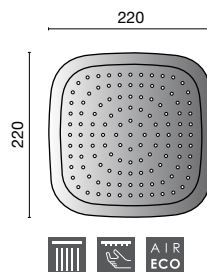

Rociador 20 cm. con rótula, función lluvia.  
20 cm. rain shower head, with ball joint.

chromo - chrome 100094135 - N199999729  
chromo/blanco - chrome/white 100094136 - N199999727



ROCIADORES / SHOWER HEADS

urban



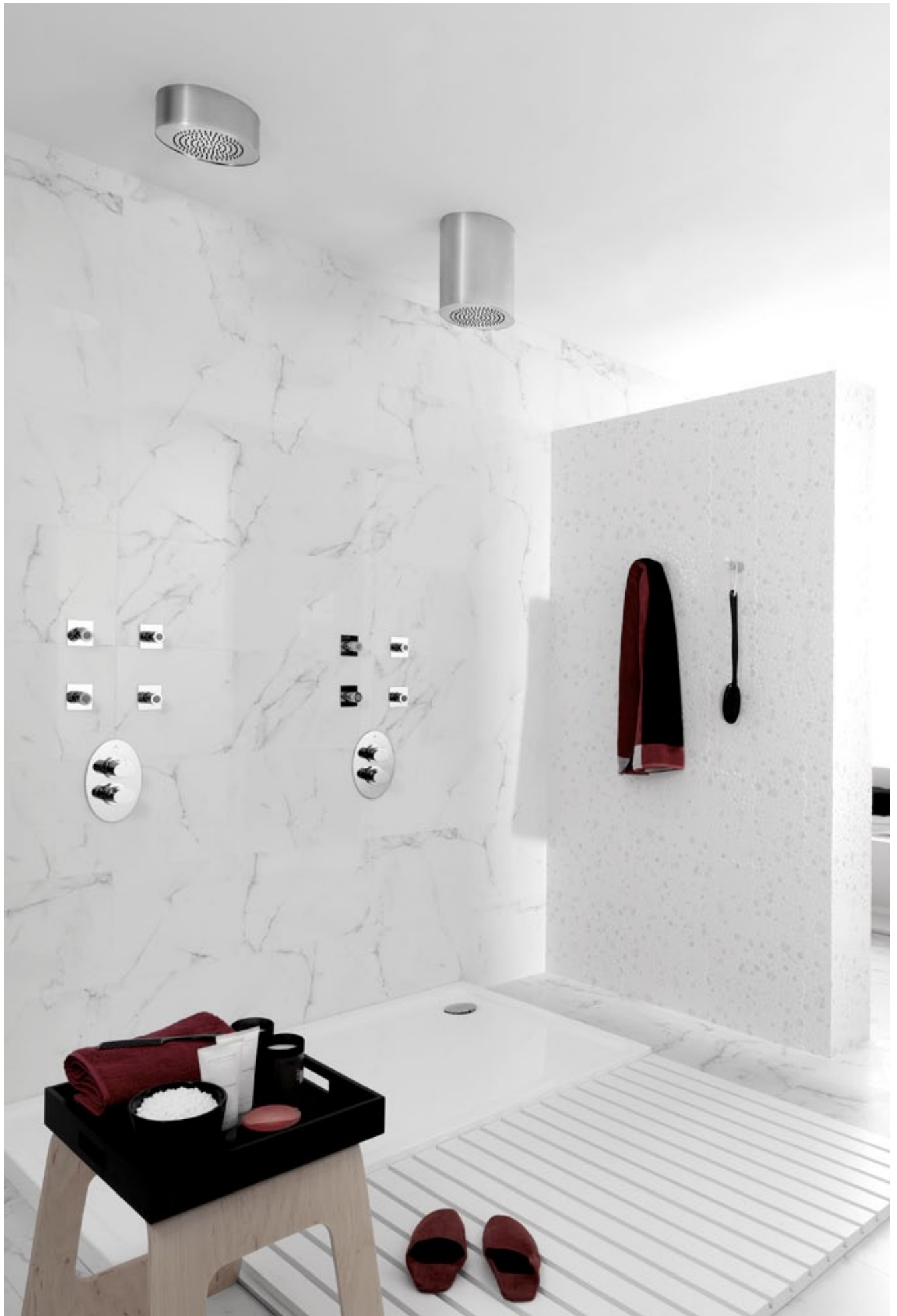

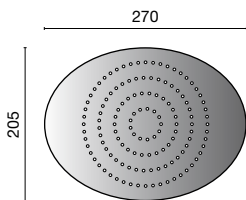

Rociador instalación a techo 9 cm.  
9 cm. Shower head.

chromo - chrome 100038681 - N160458501

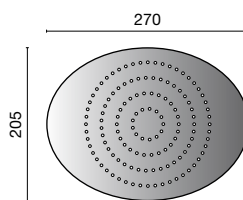

Rociador instalación a techo 30 cm..  
30 cm. Shower head.

chromo - chrome 100038680 - N160450001



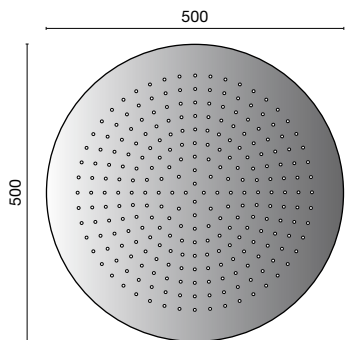

Rociador Rondo 50 cm., sin rótula.  
Rondo 50 cm rain shower head, without ball joint.

chromo - chrome 100090358 - N192579922

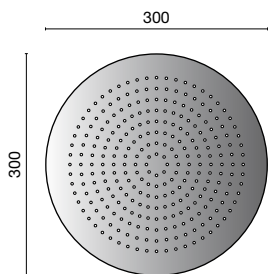

Rociador Rondo 30 cm., con rótula (7) (8).  
Rondo 30 cm rain shower head, with ball joint (7) (8).

chromo - chrome 100090796 - N192579931

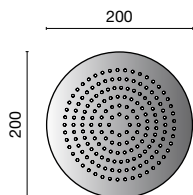

Rociador Rondo 20 cm., con rótula (7) (8).  
Rondo 20 cm rain shower head, with ball joint (7) (8).

chromo - chrome 100090795 - N192579930

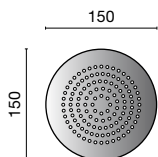

Rociador Rondo 15 cm., con rótula (1) (2).  
Rondo 15 cm rain shower head, with ball joint (1) (2).

chromo - chrome 100090334 - N192579920

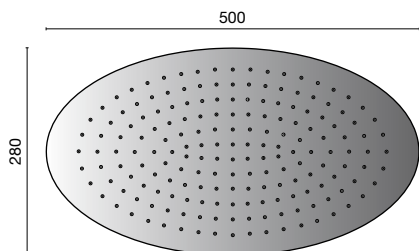

Rociador Oval 50x28 cm., sin rótula (5) (6).  
Oval 50x28 rain shower head, without ball joint (5) (6).

chromo - chrome 100098844 - N192579936

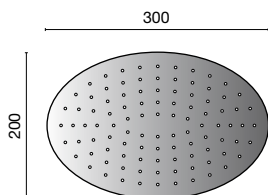

Rociador Oval 30x20 cm., con rótula (5) (6).  
Oval 30x20 rain shower head, with ball joint (5) (6).

chromo - chrome 100090355 - N192579923



ROCIADORES / SHOWER HEADS

# neptune

slim



- (1) Recomendamos para la instalacion a pared el brazo 100090430 o 100039088
- (2) Recomendamos para la instalacion a techo el brazo 100090331
- (5) Recomendamos para la instalacion a pared el brazo 100063878
- (6) Recomendamos para la instalacion a techo el brazo 100090331
- (7) Recomendamos para la instalacion a pared el brazo 100039088
- (8) Recomendamos para la instalacion a techo el brazo 100090331

- (1) We recommend for wall installation, the arm 100090430 or 100039088
- (2) We recommend for ceiling installation the arm 100090331
- (5) We recommend for wall installation, the arm 100063878
- (6) We recommend for ceiling installation the arm 100090331
- (7) We recommend for wall installation, the arm 100039088
- (8) We recommend for ceiling installation the arm 100090331

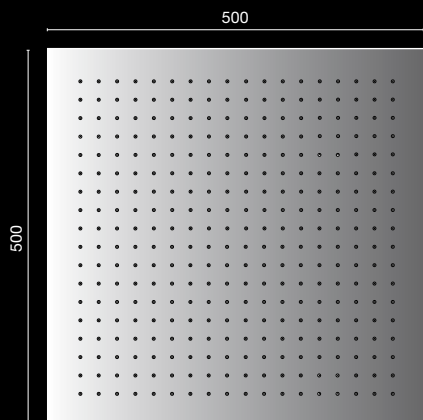

Rociador Square 50x50 cm., sin rótula (1) (2).  
*Square 50x50 cm. rain shower head, without ball joint (1) (2).*

chromo - chrome 100102276 - N192579938

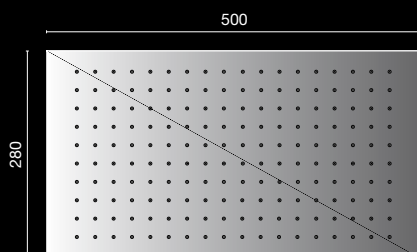

Rociador Recto 50x28 cm., sin rótula (3) (4).  
*Recto 50x28 shower head, without ball joint (3) (4).*

Chromo - Chrome 100098845 - N192579937

Diseño atractivo y tamaño considerable son los requisitos mínimos que debe reunir una ducha hoy en día. Gracias a su diseño y funcionalidad, el rociador Neptune Square 50 cm. es desde hace años un modelo de éxito entre las duchas Noken. Con un tamaño de 500 mm, esta ducha reparte el agua ampliamente por todo el cuerpo. Su diseño definido y atemporal la convierte en un elemento perfectamente combinable en cualquier baño.

Attractive design and considerable size are the minimum requirements that must meet a today shower experience. Thanks to its design and functionality, the Neptune Square 50 cm. overhead shower has been a successful model for years. With a generous dimension of 500 mm, this shower distributes water widely over the body. Defined and timeless design makes it a perfectly combined element in any bathroom.

(1) Para la instalacion a pared sólo es compatible con el brazo 100102273

(2) Recomendamos para la instalacion a techo el brazo 100047346

(1) If installing it to the wall, only compatible with arm 100102273

(2) We recommend for ceiling instalation the arm 100047346

(3) Recomendamos para la instalacion a pared el brazo 100090428, 100039090 o 100090332

(4) Recomendamos para la instalacion a techo el brazo 100047346

(3) We recommend for wall installation, the arm 100090428, 100039090 or 100090332

(4) We recommend for ceiling instalation the arm 100047346



# neptune

slim

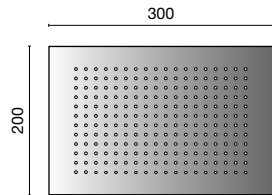

**Rociador Recto 30x20 cm., con rótula.**  
*Recto 30 x 20 shower head, with ball joint.*

chromo - chrome 100090357 - N192579924

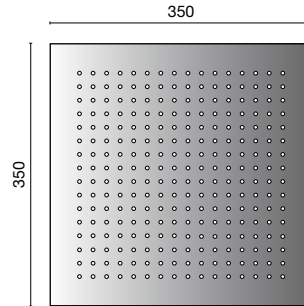

**Rociador Square 35 cm., con rótula.**  
*Square 35 cm rain shower head, with ball joint.*

chromo - chrome 100090359 - N192579925

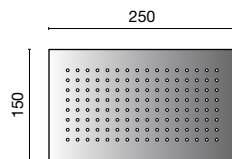

**Rociador Recto 25x15 cm., con rótula.**  
*Recto 25 x 15 rain shower head, with ball joint.*

chromo - chrome 100090356 - N192579926

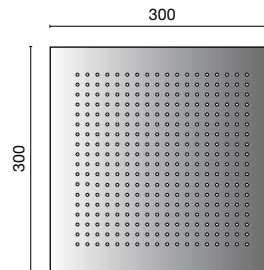

**Rociador Square 30 cm., con rótula.**  
*Square 30 cm rain shower head, with ball joint.*

chromo - chrome 100090329 - N192579916

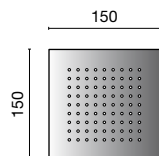

**Rociador Square 15 cm., con rótula.**  
*Square 15 cm rain shower head, with ball joint.*

chromo - chrome 100090328 - N192579917

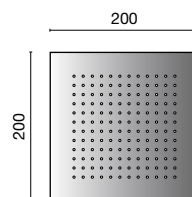

**Rociador Square 20 cm., con rótula.**  
*Square 20 cm rain shower head, with ball joint.*

chromo - chrome 100090335 - N192579921



# encastres

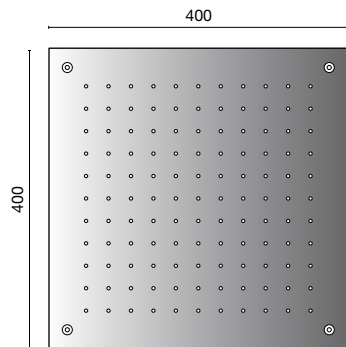

**NK LOGIC**  
Rociador encastre techo Square 40 cm.  
*Ceiling mounted Square 40 cm rain shower head.*

espejo - mirror 100090738 - N186490002

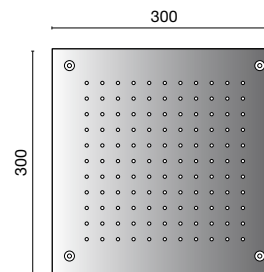

**NK LOGIC**  
Rociador encastre techo Square 30 cm.  
*Ceiling mounted Square 30 cm rain shower head.*

espejo - mirror 100090737 - N186490003

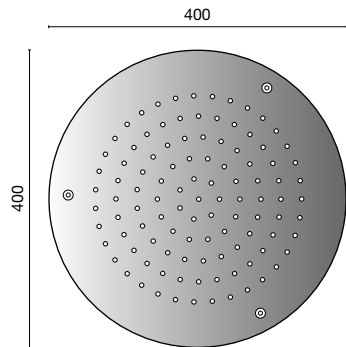

**BELA**  
Rociador encastre techo Rondo 40 cm.  
*Ceiling mounted Rondo 40 cm rain shower head.*

espejo - mirror 100090721 - N185709903

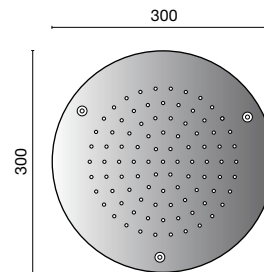

**BELA**  
Rociador encastre techo Rondo 30 cm.  
*Ceiling mounted Rondo 30 cm rain shower head.*

espejo - mirror 100090720 - N185709904



**FORCE**  
Brazo y rociador.  
*Shower arm and shower head.*

chromo - chrome 100083442 - N153410595  
oro brillo - polished gold 100083443 - N153410594



**CENTURY**  
Brazo y rociador.  
*Shower arm and shower head.*

chromo - chrome 100083440 - N156416572  
oro brillo - polished gold 100083441 - N156416573



**FUTURE**  
Kit Future rociador 20 cm.+brazo.  
*Future 20 cm rain shower head + arm kit.*

chromo - chrome 100082839 - N134650016  
oro PVD - gold PVD 100082840 - N134650018



**NOSTALGIA**  
Brazo y rociador.  
*Shower arm and shower head.*

chromo - chrome 100083444 - N124131572  
oro brillo - polished gold 100083445 - N124131573



**DINASTY**  
Rociador 22 cm., con rótula.  
*22 cm rain shower head with ball joint.*

chromo - chrome 100090440 - N199999805

ROCIADORES / SHOWER HEADS

# clásicos



## PROGRAMA BRAZOS / SHOWER ARM PRODUCT RANGE



Brazo rociador Square de 45 cm especial gran carga para instalación a pared.  
*Square 45 cm. shower head arm for special wall installation.*

chromo - chrome 100102273 - N199999675



Brazo rociador Extraplano de 40 cm a pared.  
*Extra Slim 400 mm shower head arm, wall connection.*

chromo - chrome 100090428 - N192579935



Brazo rociador Recto de 40 cm a pared.  
*Recto 400 mm shower head arm, wall connection.*

chromo - chrome 100039090 - N192452501



Brazo rociador Square de 40 cm a pared.  
*Square 400 mm shower head arm, wall connection.*

chromo - chrome 100090332 - N192579918



Brazo rociador Oval de 40 cm a pared.  
*Oval 400 mm shower head arm, wall connection.*

chromo - chrome 100063878 - N192579908



Brazo rociador Rondo de 40 cm a pared.  
*Rondo 400 mm shower head arm, wall connection.*

chromo - chrome 100039088 - N192452301



URBAN - Brazo rociador de 40 cm. a pared.  
*URBAN - Shower head arm, wall connection.*

chromo - chrome 100094150 - N199999733



Brazo rociador Clasico de 40 cm a pared.  
*Classic 400 mm shower head arm, wall connection.*

chromo - chrome 100039089 - N192452401



Brazo rociador Square de 18 cm a pared.  
*Square 180 mm shower head arm, wall connection.*

(1) chromo - chrome 100090431 - N192579933



Brazo rociador Rondo de 18 cm a pared.  
*Rondo 180 mm shower head arm, wall connection.*

(1) chromo - chrome 100090430 - N192579934



Brazo Square 20 cm a techo.  
*Square 200 mm shower head arm, ceiling connection.*

chromo - chrome 100047346 - N192459501



Brazo Rondo 20 cm a techo.  
*Rondo 200 mm shower head arm, ceiling connection.*

chromo - chrome 100090331 - N192579919





# JETS

## BODY JETS

Una apuesta segura a la hora de equipar el espacio de baño de forma simple, elegante y funcional es optar por la combinación de plato de ducha y mampara. Ambos elementos, se adaptan a las necesidades del espacio con un planteamiento dinámico, fresco y vanguardista. Y es que los hábitos diarios hacen de la ducha, una pieza básica dentro de la estancia, capaz de rendir tributo a la funcionalidad a partir de un diseño puro, sereno y minimalista. Además, la posibilidad de ir acompañadas de griferías termostáticas así como de diferentes modelos de jets o rociadores aumenta considerablemente sus cualidades con un plus de bienestar y confort. Basta con valorar las posibilidades que nos brinda la estancia, elegir entre toda la gama de propuestas de Noken y disfrutar de una placentera ducha.

A safe bet to use the bathroom space in a simple, elegant and functional way is opting for the combination of shower tray and screen. Both elements are adapted to the needs of a dynamic, fresh, avant-garde approach of space.

As showering is daily habit, the shower is a basic piece in our bathroom, able to pay tribute to the functionality as a pure, serene and minimalist design. In addition, the possibility to be accompanied by thermostatic mixers and multi-function hand showers with hydro-massage significantly increases its qualities with a plus of comfort and well-being. Just value the opportunities that the bathroom provides us and choose from the vast range of shower proposals from Noken to enjoy a pleasant shower experience.







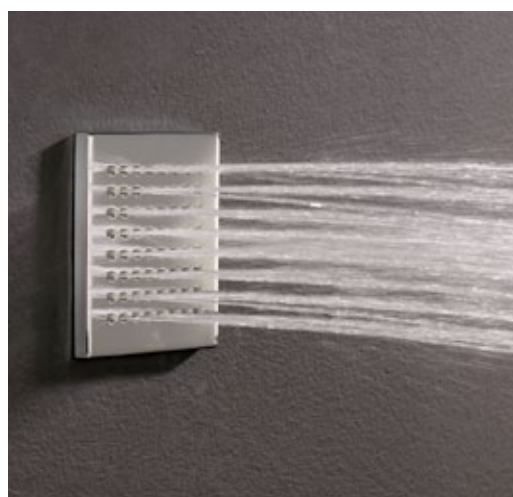
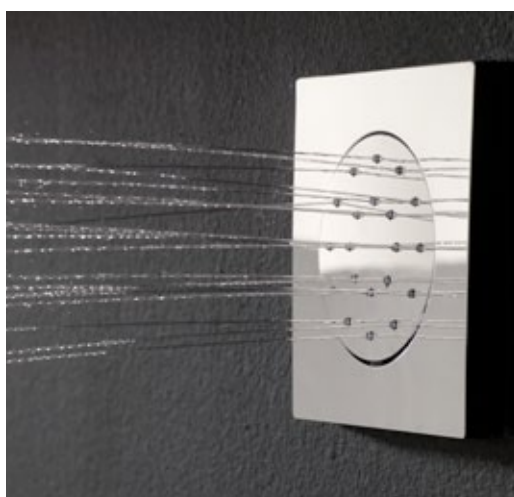
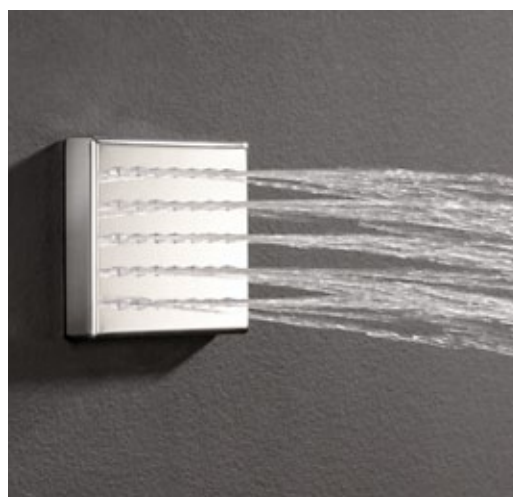
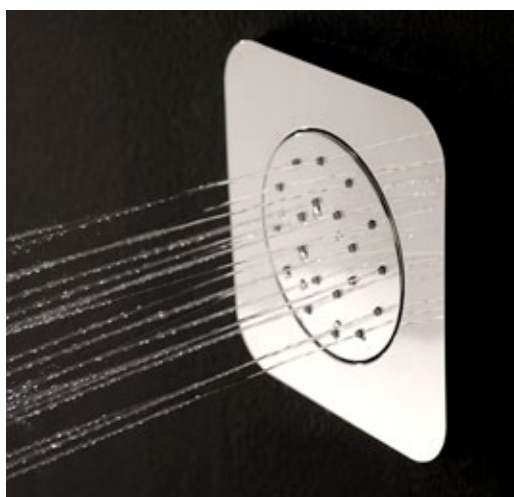
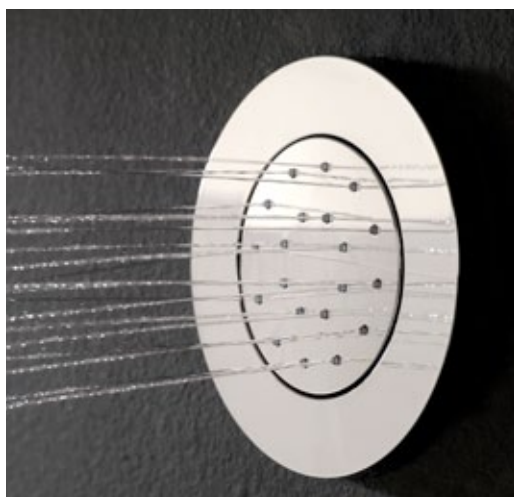



130

130



**ESSENCE-C**  
 Jet lateral de ducha orientable con conexiones de 1/2".  
*1/2" concealed body jet.*

Cromo - chrome 100093548 - N183050312

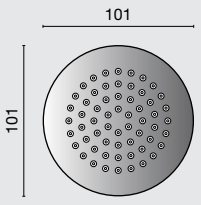

101

101



**GIRO**  
 Jet con conexiones de 1/2".  
*Wall mounted body jet 1/2".*

Cromo - chrome 100063836 - N199999975



125

125



**LOUNGE**  
 Jet lateral de ducha orientable con conexiones de 1/2".  
*1/2" concealed body jet.*

Cromo - chrome 100093549 - N199999773

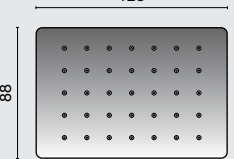

128

88



**LOUNGE**  
 Jet acero inox de conexión 1/2".  
*Wall mounted body jet 1/2".*

espejo - mirror 100063835 - N199999974  
 blanco - white 100093573 - N199999769



125

125



**SOFT**  
 Jet lateral de ducha orientable con conexiones de 1/2".  
*1/2" concealed body jet.*

Cromo - chrome 100093550 - N196599512

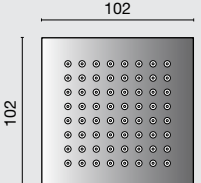

102

102



**NK LOGIC**  
 Jet con conexiones de 1/2".  
*Wall mounted body jet 1/2".*

Cromo - chrome 100065936 - N140140023



# AIR ECO

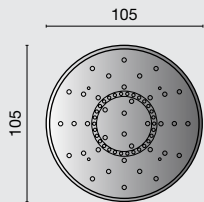

## HOTELS

Jet lateral ducha orientable con sistema AIR ECO, conexión 1/2".  
Adjustable side shower jet with AIR ECO system, 1/2" connection.

chromo - chrome 100093572 - N19999768

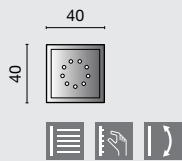

## SQUARE

Jet lateral de ducha orientable.  
Concealed body jet.

chromo - chrome 100039216 - N199617701

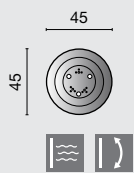
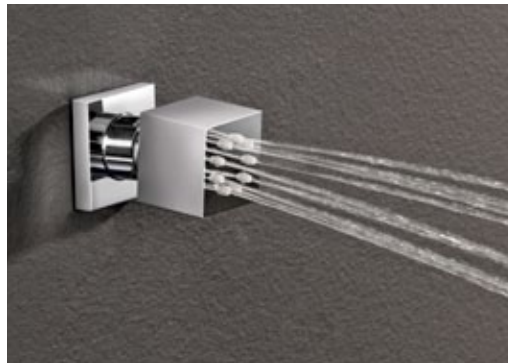

## BELA

Jet con función masaje.  
Wall mounted body jet massage.

chromo - chrome 100069248 - N168199920

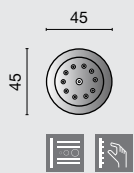

## BELA

Jet con función lluvia + vapor.  
Wall mounted body jet rain mist.

chromo - chrome 100069249 - N168199919





# TERMOSTÁTICAS

## THERMOSTATIC VALVES

El sistema termostático presenta la ventaja de mantener constante la temperatura del agua elegida gracias a la sincronización del mando con el cartucho. Es ideal instalarlo en instalaciones con acumulación de agua caliente, ya sea tanto termos eléctricos, calderas de gas o calentadores de gas con acumulador. También son compatibles con calentadores instantáneos, ya sean de gas o eléctricos, aunque el rendimiento de la termostática dependerá de la calidad de la instalación. Las termostáticas tienen además un sistema de protección anti quemadura por cortes de suministro de agua fría o caliente.

Siguiendo con nuestra política de mejora continua, en los últimos años hemos rediseñado totalmente nuestros productos para acelerar la velocidad de mezclado y el tiempo que necesita el sistema para reaccionar a cambios repentinos de temperatura. Consiguiendo de esta forma un ahorro en el consumo de agua.

No podemos olvidar una de las características más relevantes de nuestras termostáticas, su comodidad. La temperatura, siempre constante, evita el riesgo de quemaduras. Relacionado con la seguridad, tenemos que destacar el hecho de que ante un corte en el suministro de agua fría, el cartucho de la termostática cierra automáticamente el agua caliente, evitando una vez más el riesgo de quemaduras.

Además, este producto es el ideal para aquellas familias que tienen niños en casa. Ya que, nuestros modelos incluyen el botón de seguridad que limita la temperatura a 38 grados, evitando así cualquier accidente.

A thermostatic system offers the advantage of maintaining a pre-selected constant water temperature thanks to the synchronization of the command button with the cartridge. It is ideal to install in facilities with accumulation of hot water, whether by electric water heaters, gas boilers or accumulator gas heaters. It is also compatible with instantaneous heaters, whether gas or electric, although the performance of the thermostatic will depend on the quality of the installation.

Continuing with our policy of continuous improvement, in recent years we have redesigned completely our products to accelerate the speed of mixing and the time necessary for the system to react to sudden temperature changes and this contribute to saving water consumption.

We must not forget that one of the major characteristics of our thermostatic mixer is comfort. Moreover, a constant water temperature avoids the risk of burns. Related to security, we must underline the fact that a failure in the cold water supply will automatically closes the hot water entry to the thermostatic cartridge, once again avoiding the risk of burns.

In addition, this product is ideal for those families who have children at home. Since, our models include a safety button that limits the temperature at 38 degrees to avoid domestic accidents.







TERMOSTÁTICAS / THERMOSTATIC VALVES

## giro

Gracias a la innovadora tecnología que poseen las griferías termostáticas de Noken, podrás disfrutar del agua a la temperatura constante que pide tu cuerpo, desde la primera a la última gota y justo con el caudal de agua que te gusta. Esta es la base para gozar de una excelente ducha. Con las griferías termostáticas de Noken tus estimulantes duchas y tus relajantes baños van a rozar la perfección.



**GIRO**  
Llave de paso con conexiones de 3/4".  
*Wall mounted stop valve 3/4"*

chromo - chrome 100063492 - N199999979



**GIRO**  
Termostática encastre con termoelemento de cera incorporado.  
Conexiones de 3/4". Incluye válvula anti-retorno y stop de seguridad a 38°C.  
*Concealed thermostatic 3/4" with wax thermostatic element. Built in non-return valve, safety stop at 38°C (for a correct use this item needs to be combined with a deckmounted control).*

(1) chromo - chrome 100063485 - N299999891

(1)  
Es obligatorio pedir este artículo junto con una llave de paso como mínimo 100063492-N199999979  
*Is required to order this item with a 3/4" wall mounted stop valve at least 100063492-N199999979.*





Thanks to innovative technology with Noken thermostatic mixers, you can enjoy water at a constant temperature, from the first to the last drop and only at the flow rate you like. This is the basis for an excellent shower. Noken thermostatic mixers will make your shower stimulating and relaxing, as close to perfection as possible.



**SOFT**

Llave de paso con conexiones de 3/4". El caudal a 3 bares (con agua mezclada) es de 73 l/min.

*Wall mounted stop valve 3/4". Flow rate (mixed water) 73 l/min. at 3 bar.*

chromo - chrome 100093574 - N196599514



**SOFT**

Termostática encastre 1 salida con termoelemento de cera incorporado. Conexiones de 3/4". Incluye válvula anti-retorno y stop de seguridad a 38°C. El caudal a 3 bares (con agua mezclada) es de 60 l/min.

*Concealed thermostatic 1 way 3/4" with wax thermostatic element. Built in non-return valve. Safety stop at 38°C. Flow rate (mixed water) 60 l/min. at 3 bar.*

(1) chromo - chrome 100093579 - N196599513

**(1)**

Es obligatorio pedir este artículo junto con una llave de paso como mínimo 100093574 - N196599514.

*Is required to order this item with a 3/4" wall mounted stop valve at least 100093574 - N196599514.*

## TERMOSTÁTICAS / THERMOSTATIC VALVES

**BASIC**

Termostática externo ducha con termoelemento de cera incorporado. Conexiones de 1/2". Incluye válvula anti retorno, stop de seguridad a 38° y ECOSTOP.

*Wall mounted exposed thermostatic shower mixer 1/2" with wax thermostatic element. Built in non-return valve. Safety stop at 38°C and ECOSTOP button.*

chromo - chrome 100059722 - N199999995

**BASIC**

Termostática encastre 1 salida con termoelemento de cera incorporado. Conexiones de 1/2". El caudal a 3 bares (con agua mezclada) es de 25 l/min. Incluye válvula anti-retorno y stop de seguridad a 38°C.

*Concealed thermostatic 1 way 1/2" with wax thermostatic element. Flow rate 25 l/min. at 3 bar. Built in non-return valve. Safety stop at 38°C.*

chromo - chrome 100059730 - N299999963

**BASIC**

Termostática encastre 2 salidas con termoelemento de cera incorporado. Conexiones de 1/2". Inversor regulador de caudal. El caudal a 3 bares (con agua mezclada) es para el baño de 24,5 l/min. y para la ducha 15 l/min. Incluye válvula anti-retorno y stop de seguridad a 38°.

*Concealed thermostatic 2 ways 1/2" with wax thermostatic element. Diverter valve with integrated shut off 1/2". Flow rate bath 24,5 l/min. at 3 bar and flow rate shower 15 l/min. at 3 bar. Built in non-return valve. Safety stop at 38°C.*

chromo - chrome 100059732 - N299999969

**URBAN**

Termostática encastre 2 salidas con termoelemento de cera incorporado. Conexiones de 1/2" - 3/4" según plano. Inversor regulador de caudal. El caudal a 3 bares (con agua mezclada) es de 1 salida 26 l/min. y de la otra 13 l/min. Incluye válvula anti retorno y stop de seguridad a 38°.

*Concealed thermostatic 2 ways 1/2"-3/4" (like technical drawing) with wax thermostatic element. Diverter valve with integrated shut off 1/2". Flow rate bath 26 l/min. at 3 bar and flow rate shower 13 l/min. at 3 bar. Built in non-return valve. Safety stop at 38°C.*

chromo - chrome 100063403 - N111390004

**URBAN**

Termostática encastre 3 salidas (2 manetas) con termoelemento de cera incorporado. Conexiones de 1/2" - 3/4" según plano. Inversor regulador de caudal. Incluye válvula anti retorno y stop de seguridad a 38°C.

*Concealed thermostatic 3 ways 1/2"-3/4" (like technical drawing) with wax thermostatic element. Diverter valve with integrated shut off 1/2". Built in non-return valve. Safety stop at 38°C.*

chromo - chrome 100063389 - N111390002

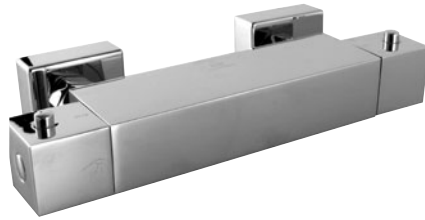

**ACRO-N**  
 Termostática externo ducha con termoelemento de cera incorporado. Conexiones de 1/2". Incluye válvula anti retorno, stop de seguridad a 38° y ECOSTOP. Distancia excéntricas 150 +/-20 mm.  
*Wall mounted exposed thermostatic bath shower mixer 1/2" with wax thermostatic element. Built in non-return valve, safety stop at 38°C and ECOSTOP button. Centre distance 150 +/-20 mm.*

chromo - chrome 100038886 - N172390001



**URBAN**  
 Termostática encastre 3 salidas (3 manetas) con termoelemento de cera incorporado. Conexiones de 1/2" - 3/4" según plano. Inversor regulador de caudal. El caudal a 3 bares (con agua mezclada) es de 1 salida 26 l/min., otra de 16 l/min. y la última 45,5 l/min. Incluye 1 salida de gran caudal con maneta independiente, válvula anti retorno y stop de seguridad a 38°C.  
*Concealed thermostatic 3 ways 1/2"-3/4" (like technical drawing) with wax thermostatic element. diverter valve with integrated shut off 1/2". flow rate (one outlet) 26 l/min.at 3 bar, flow rate (other outlet) 16 l/min. at 3 bar and flow rate (the last one is high flow outlet) 45,5 l/min. at 3 bar. Built in non-return valve. Safety stop at 38°C..*

chromo - chrome 100063400 - N111390003



**NK LOGIC**  
 Termostática encastre 3 salidas (3 manetas) con termoelemento de cera incorporado. Conexiones de 1/2" - 3/4" según plano. Inversor regulador de caudal. El caudal a 3 bares (con agua mezclada) es de 1 salida 26 l/min, otra de 16 l/min. y la última 45,5 l/min. Incluye 1 salida de gran caudal con maneta independiente, válvula anti retorno y stop de seguridad a 38°C.  
*Concealed thermostatic 3 ways 1/2"-3/4" (like technical drawing) with wax thermostatic element. Diverter valve with integrated shut off 1/2". Flow rate (one outlet) 26 l/min.at 3 bar, flow rate (other outlet) 16 l/min. at 3 bar and flow rate (the last one is high flow outlet) 45,5 l/min.at 3 bar. Built in non-return valve. Safety stop at 38°C.*

chromo - chrome 100063401 - N172390002



**NK LOGIC**  
 Termostática encastre 2 salidas con termoelemento de cera incorporado. Conexiones de 1/2" - 3/4" según plano. Inversor regulador de caudal. El caudal a 3 bares (con agua mezclada) es de 1 salida 26 l/min. y de la otra de 13 l/min. Incluye válvula anti retorno y stop de seguridad a 38°C..  
*Concealed thermostatic 2 ways 1/2"- 3/4" (like technical drawing) with wax thermostatic element. Diverter valve with integrated shut off 1/2". Flow rate bath 26 l/min. At 3 bar and flow rate shower 13 l/min.at 3 bar. Built in non-return valve. Safety stop at 38°C..*

chromo - chrome 100063404 - N140140008



**NK LOGIC**  
 Termostática encastre 3 salidas (2 manetas) con termoelemento de cera incorporado. conexiones de 1/2" - 3/4" según plano. Inversor regulador de caudal. incluye válvula anti retorno y stop de seguridad a 38°C.  
*Concealed thermostatic 3 ways 1/2"- 3/4" (like technical drawing) with wax thermostatic element. Diverter valve with integrated shut off 1/2". Built in non-return valve. Safety stop at 38°C.*

chromo - chrome 100063402 - N172390003

# TELEDUCHAS SHOWER HANDSETS

pasión por  
**el agua**

El agua forma parte de todas las cosas que amamos y de las que tanto nos gusta rodearnos. Se encuentra ornamentando, en forma de nube, la bóveda azul que nos envuelve. Es el elemento esencial en mares y ríos y sin ella no podríamos disfrutar ni de la fragancia de una flor ni del tonificante placer del baño. Nada seríamos sin ella. Amamos el agua y la respetamos como el bien más preciado. Por eso, ponemos todo nuestro empeño en obtener del mínimo consumo, el máximo de prestaciones.

passion for  
**the water**

Water is part of all the things we love and that we like to surround ourselves with. It can be found ornamenting, in the form of a cloud, the Blue Dome that surrounds us. It is the essential element in seas and rivers, and without it we could not enjoy nor of the fragrance of a flower or the toning showering pleasure. We would be nothing without it. We love and respect water as the most precious asset. For this reason, we put all our efforts to obtain the minimum consumption with the maximum of benefits.

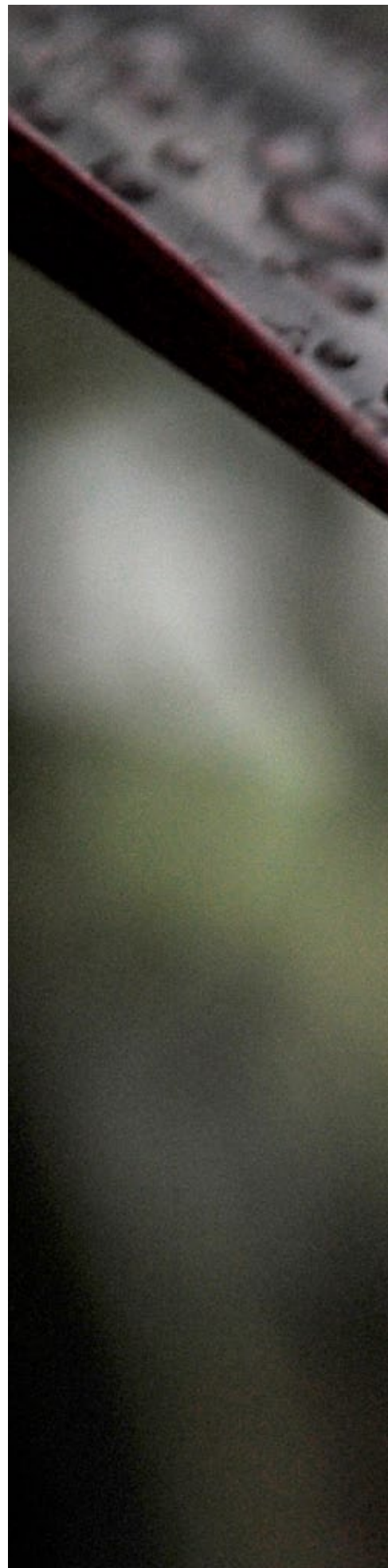



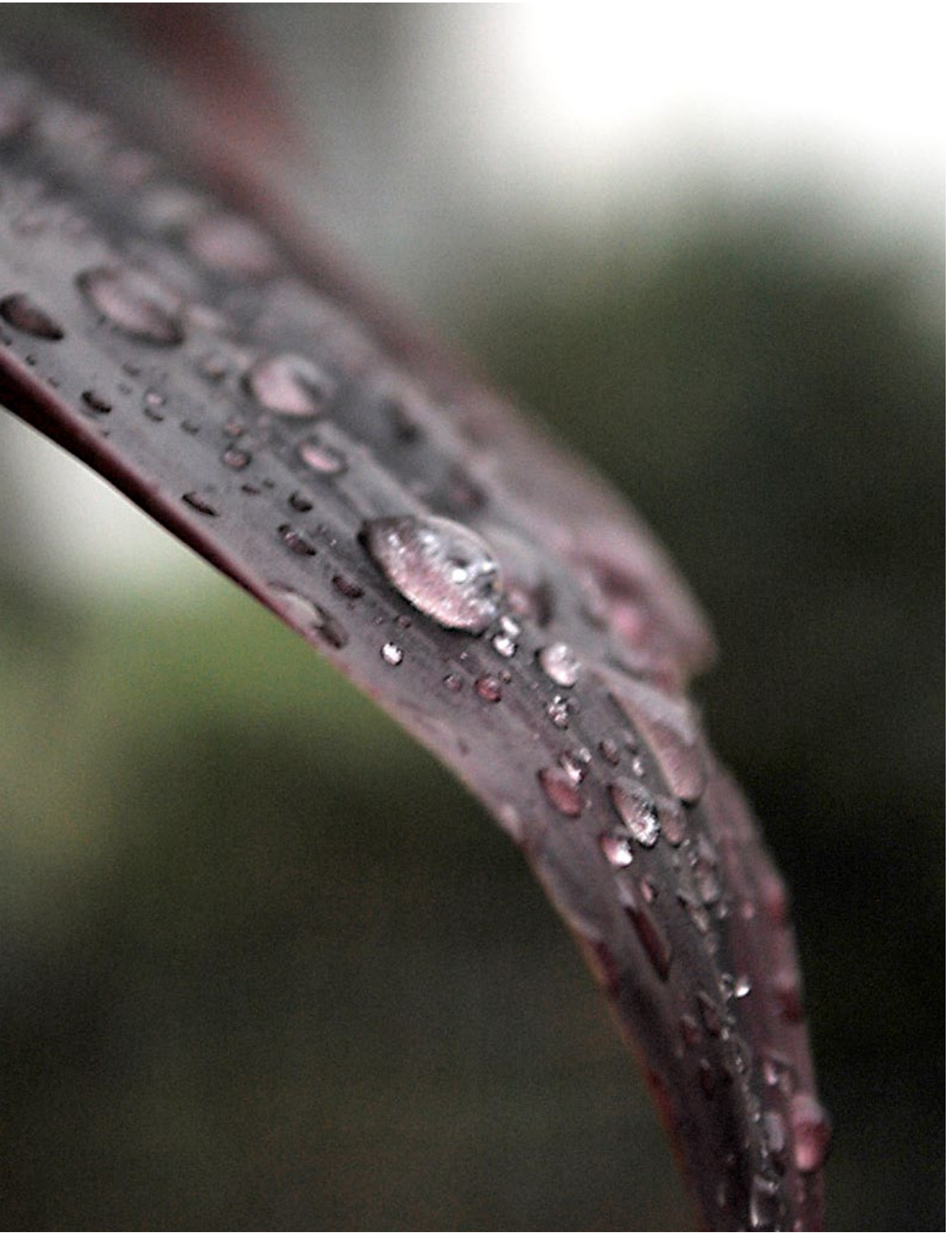



62

noken **showers** 2011



CAZ  
Teleducha 5 funciones con conexiones de 1/2".  
5 spray handshower anti-limescale system.

chromo - chrome 100040338 - N299279401

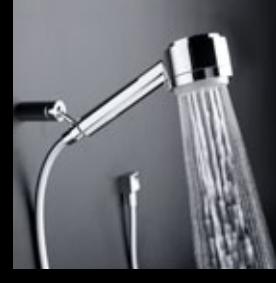
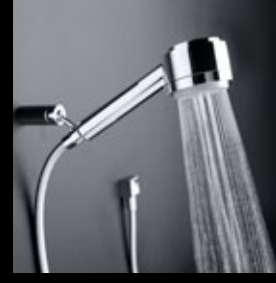
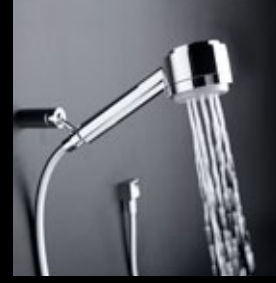

TELEDUCHAS / SHOWER HANDSETS

caz



noken showers 2011



### Tecnología Eco

Menos agua, menos energía y menos CO2

¿Cómo se puede conseguir que menos agua cunda mucho más? Muy sencillo, con la tecnología Eco de Noken. Un ingenioso limitador de caudal, unas toberas especiales y la incorporación de aire hacen posible que el consumo de agua se reduzca a 6 o a 12 l/min sin alterar el elevado nivel de confort de ducha. Una técnica que permite además ahorrar energía puesto que el volumen de agua que se debe calentar es menor. Así, ya desde la ducha empezamos a contribuir a la protección del medio ambiente.

### Eco Technology

Less water, less energy and less CO2.

How do we achieve that less water becomes more? It is very simple, with the ECO technology. A clever flow restrictor, a special spray nozzle and the incorporation of air make it possible that water consumption is reduced to 6 or 12 l/min without altering the high level of comfort of showering. It concerns a technique that also allows energy saving because the volume of water that needs heating is lower. A small contribution to the protection of the environment starts with an ECO technology shower.



El limitador se puede montar en la conexión entre el grifo y el flexible o entre el flexible y la teleducha.

El limitador se puede montar en la conexión entre el grifo y el flexible o entre el flexible y la teleducha.

The water restrictor can be used in the connection between the mixer and the flexi hose or between the flexi hose and the hand shower.

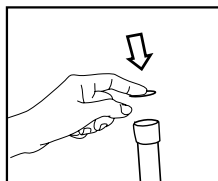
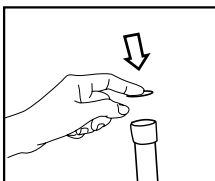
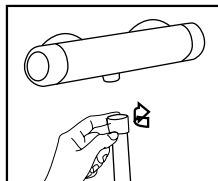
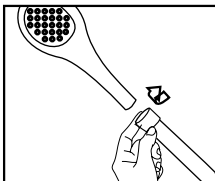

# AIR ECO

“AIR ECO” también significa que el agua, al mezclarse con el aire, se aprovecha mejor, por lo que se contrarresta la alta demanda de agua de las duchas grandes. En las duchas con el sistema AIR ECO se reduce el consumo de agua incluso en un 10 % y la calidad del chorro mejora. Comparándola con la tecnología en duchas convencionales, se tiene la impresión de un volumen de agua incluso superior.



“AIR ECO” also means that the water, when mixed with air, is more beneficial, which offsets the high demand for big size rain showers. The showers equipped with an ECO AIR system reduce the consumption of water even at and improves the quality of the water flow. When compared to the technology in conventional showers, the perception of a water volume is even higher.



AIR  
ECO

Seguramente hemos despertado su curiosidad. ¿Cómo funciona la innovadora técnica AIR ECO? ¿Cómo penetra el beneficioso aire en el agua de la ducha? Se lo explicamos: gracias a un orificio en el centro del cabezal de la teleducha se succiona el aire y se mezcla con el agua saliente. ¡A un litro de agua le corresponden 3 litros de aire! La consecuencia: mientras se aumenta el volumen de las gotas de agua, éstas tienen al mismo tiempo un efecto más ligero y suave. En lugar del típico chorro de ducha en forma de hilos, millones de gotas de lluvia voluminosas acarician la piel y el cuerpo se ve completamente envuelto en una agradable película de agua y aire.

Surely we have aroused your curiosity. How does the innovative AIR ECO technology works? How does air enters inside the shower head and becomes mixed with water? The explanation is very simple, air is absorbed by a specially designed conduct in the centre of the shower head or hand shower and gets mixed with the outgoing water spray. One litre of water transforms as much as 3 litres of air! The result is that when you increase the volume of water droplets, they become more lightweight and have a softer effect. Instead of the typical water spray in the form of thread, millions of voluminous raindrops caress the skin and your body becomes completely wrapped in a nice cover of water and air.





Nos hemos vuelto más sensibles con todo lo relacionado con nuestros cuerpos y su cuidado. Por ello, festejamos lo cotidiano para enriquecer nuestra vida. Gracias a AIR ECO de Noken la ducha diaria se convierte en un placer para los sentidos. Para la vista:

las voluminosas gotas permiten reconocer el aire envuelto en las mismas.

Para el oído: Las gotas de agua tienen el mismo efecto que el de la lluvia tranquilizante y revitalizante.

Y para la piel, nuestro órgano sensorial más extenso: el agua enriquecida con aire no es sólo más suave,

sino que también puede transmitir mucho mejor su calor al cuerpo. De esta forma AIR ECO mima nuestros sentidos y acaricia nuestra alma.

AIR ECO marca la diferencia: sin aire el chorro "rebota", con AIR ECO se produce un contacto suave y así el agua puede distribirse mejor por toda la piel.

# AIR ECO



#### URBAN

Teleducha 2 funciones con inversor para funciones lluvia y masaje.

*Dual function hand shower with diverter for rain and massage functions.*

chromo - chrome 100094156 - N199999731

chromo/blanco - chrome/white 100094155 - N199999732



# urban



We all have become more sensitive with everything related to body care. Noken AIR ECO transforms your daily shower into a festival for the senses. Sight: bulky water drops with air wrapped inside. Hearing: you will experience water droplets creating the same effect of rain, calming and revitalising. Touch: our skin will enjoy that water enriched with air is not only softer, but it also transmits far better heat to our body. In short, AIR ECO takes care of our senses and soul..

AIR ECO makes a difference: without air the water spray "bounces back", the AIR ECO technology provides a softer touch and water can become distributed gentle at your skin.



**HOTELS**  
Teleducha 1 posición con sistema AIR ECO.  
*Single position hand shower with AIR ECO system.*

chromo - chrome 100093575 - N199999765



**HOTELS**  
Teleducha 2 funciones con sistema AIR ECO.  
Funciones: lluvia y Masaje.  
*Dual function hand shower with AIR ECO system.  
Funcions: rain & massage.*

chromo - chrome 100093576 - N199999767



# hotels



**HOTELS**  
Maneta ducha 1 posición con sistema AIR ECO.  
*Single position hand shower with AIR ECO system.*

cromo - chrome 100093577 - N199999766



**HOTELS**  
Teleducha 2 funciones con sistema AIR ECO.  
Funciones: lluvia y Masaje.  
*Dual function hand shower with AIR ECO system.  
Functions: rain & massage.*

cromo - chrome 100093578 - N199999764



BELA  
Teleducha 1 posición.  
*Single position hand shower.*

chromo - chrome 100093553 - N196599510



BELA  
Teleducha 1 posición.  
*Single position hand shower.*

chromo - chrome 100093554 - N196599515





TELEDUCHAS / SHOWER HANDSETS

**bela**

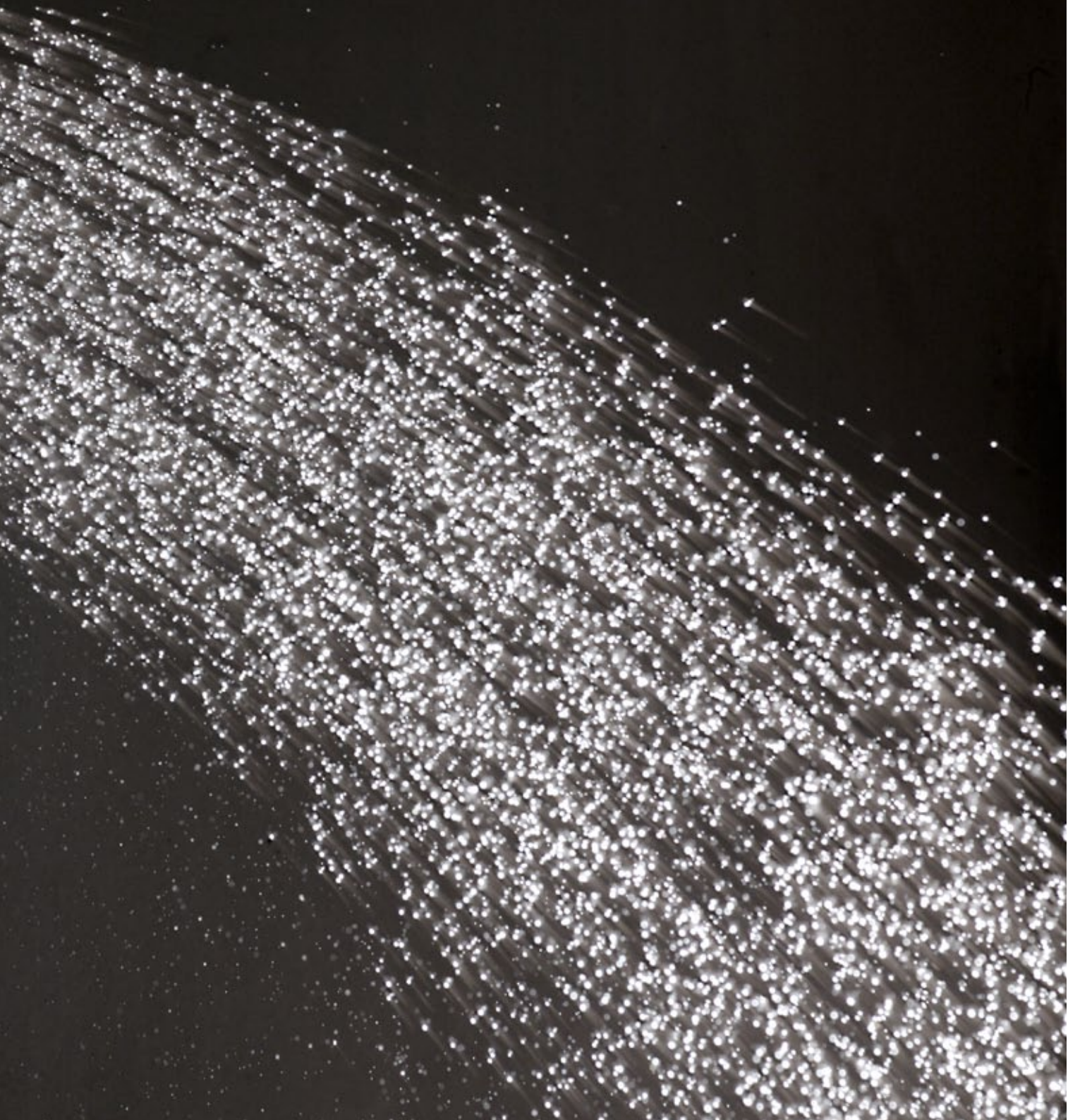



**MEDIA**

Teleducha 3 funciones con conexiones de 1/2".  
3 spray handshower anti-limescale system.

chromo - chrome 100040322 - N299272901

**PROJECT**

Teleducha 2 funciones con conexiones de 1/2".  
2 spray handshower anti-limescale system.

chromo - chrome 100040333 - N299278201





COTA  
Teleducha 1 posición.  
*Single function handshower.*

chromo - chrome 100038634 - N158760001



MINIMAL  
Teleducha 1 posición.  
*Single function handshower.*

chromo - chrome 100040325 - N299274701



# PACKS DE DUCHA

## SHOWER PACKAGES

Sentir la suave caricia del agua de lluvia, el estimulante masaje que nos proporcionan los chorros de agua o el cálido abrazo con la que nos envuelve el agua nebulizada. Incluso puedes disfrutar de la nueva sensación Eco, que ahorra un cincuenta por ciento el consumo de agua. Todo un repertorio de emociones te aguardan al entrar en contacto con el agua, a través de las duchas, los jets y los rociadores Noken.

Feel the gentle touch of water drops, stimulating massage provided by body jets or the warm embrace of the mist function. You can even enjoy the new ECO sensation, which saves up to fifty per cent of water consumption. A complete repertoire of emotions awaits you to come into contact with water by means of the Noken overhead showers, body jets and fixed showers.





# urban

## AIR ECO

Tiene que experimentar AIR ECO usted mismo con la teleducha Urban, que combina la sensación AIR ECO con el placer de ducha XXL. En el caso de la teleducha Urban los hombros y el cuerpo se rocían completamente y de manera agradable. El claro y reducido lenguaje de formas puede combinarse perfectamente con las numerosas líneas de baño puristas. El sistema de ducha Urban fusiona la teleducha, la barra y el soporte en formas redondeadas creando una unidad compacta y cerrada. La teleducha montada en el soporte regulable en altura e inclinación, permite adecuar la distancia entre la teleducha y la cabeza de la persona que disfruta de la ducha. De esta forma se puede disfrutar perfectamente de la lluvia que produce la teleducha. La esbelta y elegante silueta del sistema de ducha Urban se ajusta también a cabinas y baños pequeños, ofrece una solución a la vista que se puede reequipar y resulta ideal a la hora de renovar el baño, además revaloriza el cuarto de baño considerablemente.

You can experience the AIR ECO sensation yourself with the Urban hand shower, that combines the ECO AIR feeling with the pleasure of an XXL shower. The Urban hand shower provides a generous spray to cover shoulders and body completely in a pleasant way. Clear and reduced language of forms can perfectly be combined with numerous purist bathroom lines. The Urban Shower Pack fuses hand shower and slide rail with rounded shapes, creating a compact and closed unit. The hand shower mounted on the adjustable bracket, both in height and angle, allows you to adjust the distance between the hand kit and the position of the person taking an enjoyable shower. The slender and elegant silhouette of the Urban Shower System fits also into shower box units and small baths, creating an ideal solution to re-equip your bathroom and adding that stylish touch.

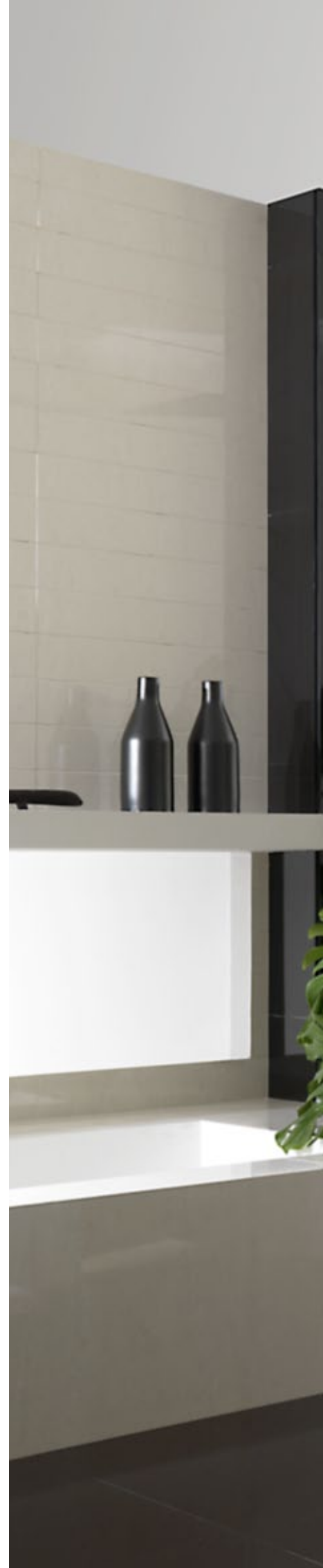





**PACK DUCHA URBAN**  
Incluye barra de ducha con soporte, teleducha URBAN con 2 funciones y flexible pvc plata.  
*URBAN SHOWER PACK*  
Includes handshower bar with bracket, 2-function URBAN handshower and flexi shower hose PVC coated twist free.

chromo - chrome 100094132 - N199999734



PACKS DE DUCHA / SHOWER PACKAGES



**PACK DUCHA BELA-C**  
 Incluye barra de ducha con soporte, teleducha CAZ (100040338-N299279401) con 5 funciones, flexible doble grapado antitorsión y toma de agua.  
*BELA-C SHOWER PACK*  
 Includes handshower bar with bracket, 5- function CAZ handshower (100040338-N299279401) with flexi shower hose chrome plated twist free and water connection.

chromo - chrome 100063971 - N168199912



**MEDIA**  
 Barra de ducha.  
*Slide rail.*

chromo - chrome  
 100039147 - N199434101



**EKO**  
 Barra de ducha.  
*Slide rail.*

chromo - chrome  
 100039148 - N199434201



**PACK DUCHA NK**  
 Incluye barra de ducha con soporte, teleducha COTA (100038634-N158760001) con 1 función y flexible pvc plata.  
*NK SHOWER PACK*  
 Includes handshower bar with bracket, 1-function COTA handshower (100038634-N158760001) and flexi shower hose PVC coated twist free hose.

chromo - chrome 100063935 - N113700003

## COMPLEMENTOS / ACCESSORIES

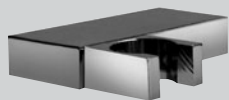

**COTA**  
Soporte maneta pared.  
*Wall bracket.*

Cromo - chrome 100038630 - N158470001

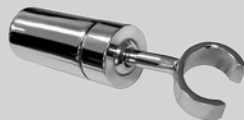

**MINIMAL**  
Soporte orientable teleducha.  
*Wall bracket.*

Cromo - chrome 100040307 - N299260501  
 Cromo mate - chrome matt 100040308 - N299260502



**CLÁSICO**  
Soporte orientable teleducha.  
*Wall bracket.*

Cromo - chrome 100039292 - N203260501  
 Oro ingles - english gold 100039293 - N203260512  
 Bronce - bronze 100039294 - N203260515



Soporte orientable teleducha.  
*Wall bracket.*

Cromo - chrome 100040315 - N299264501



**COTA**  
Soporte maneta pared con toma de agua.  
*Wall bracket with outlet elbow.*

Cromo - chrome 100038631 - N158490001



Soporte fijo teleducha.  
*Wall bracket.*

Cromo - chrome 100040314 - N299264401



**MINIMAL**  
Soporte maneta pared con toma de agua.  
*Wall bracket with outlet elbow.*

Cromo - chrome 100039121 - N198490001



Toma de agua a muro para flexible.  
*Shower outlet elbow.*

Cromo - chrome 100039176 - N199490001  
 Cromo mate - chrome matt 100039177 - N199490002  
 Blanco - white 100093561 - N199999779



**URBAN**  
Toma de agua a muro para flexible.  
*Shower outlet elbow.*

Cromo - chrome 100093563 - N199999763



**LIBERTY**  
Toma de agua.  
*Shower outlet elbow.*

Cromo - chrome 100064216 - N199999973



**SQUARE**  
Toma de agua a muro para flexible.  
*Shower outlet elbow.*

Cromo - chrome 100039030 - N186490001



**SOFT**  
Toma de agua a muro para flexible.  
*Shower outlet elbow.*

Cromo - chrome 100093562 - N196599511





150 cm.  
Flexible recubierto PVC.  
*150 cm. flexi shower hose PVC coated.*

plata - silver 100039225 - N199751142  
blanco - white 100039224 - N199751131  
negro - black 100039226 - N199751176

175 cm.  
Flexible recubierto PVC.  
*175 cm. flexi shower hose PVC coated.*

plata - silver 100065701 - N299999795



150 cm.  
Flexible doble grapado antitorsión.  
*Flexi shower hose chrome plated twist free.*

Cromo - chrome 100040293 - N299104101  
 Cromo mate - chrome - matt 100039246 - N202100002  
 Oro inglés - english gold 100039273 - N203100012  
 Oro - gold 100040291 - N299100311  
 Bronce viejo - old bronze 100040292 - N299100315

175 cm.  
Flexible doble grapado antitorsión.  
*Flexi shower hose chrome plated twist free.*

Cromo - chrome 100040296 - N299114101  
 Cromo mate - chrome - matt 100040258 - N298110302  
 Oro inglés - english gold 100040259 - N298110311  
 Oro - gold 100040260 - N298110312  
 Bronce viejo - old bronze 100040261 - N298110315

200 cm.  
Flexible doble grapado antitorsión.  
*Flexi shower hose chrome plated twist free.*

Cromo - chrome 100040298 - N299120301

150 cm.  
Flexible recubierto PVC antitorsión.  
*Flexi shower hose PVC coated twist free.*

Cromo - chrome 100040294 - N299104201

175 cm.  
Flexible recubierto PVC antitorsión.  
*Flexi shower hose PVC coated twist free.*

Cromo - chrome 100040297 - N299114201

70 cm. EXPOSICIÓN  
Flexible doble grapado antitorsión.  
*Flexi shower hose chrome plated twist free. SHOWROOM*

Cromo - chrome 100040390 - N299720301  
 Cromo mate - chrome-matt 100040391 - N299720302  
 Oro inglés - english gold 100040393 - N299720312  
 Oro - gold 100040392 - N299720311  
 Bronce viejo - old bronze 100040394 - N299720315

**nk logic**

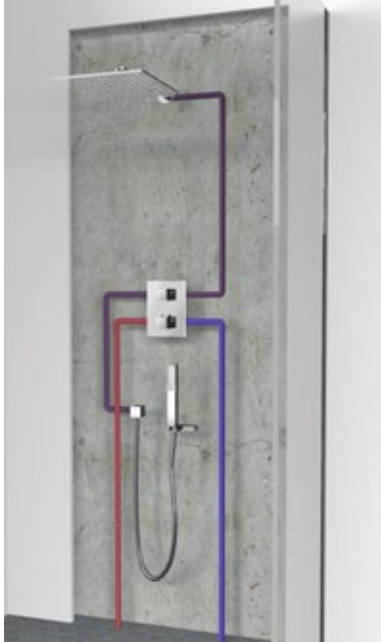

**giro**

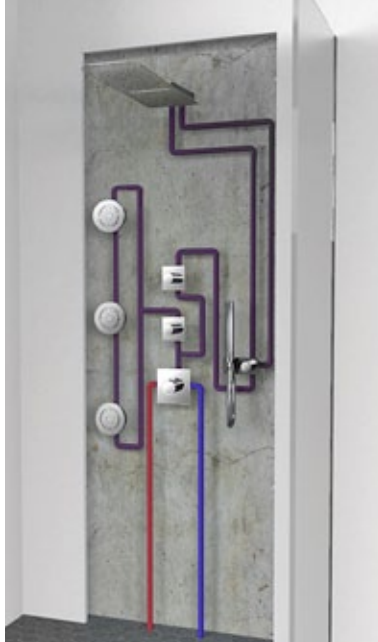

**soft**



**nk logic**



**lounge**



**essence-c**





		<b>160</b>	<b>170</b>	<b>180</b>	<b>190</b>	<b>205</b>
<b>A</b>		210	210	220	230	240
<b>B</b>		130	140	150	160	175
<b>C</b>		115	120	125	130	135
<b>D</b>		95	105	115	125	135
<b>E</b>		60	70	80	90	95

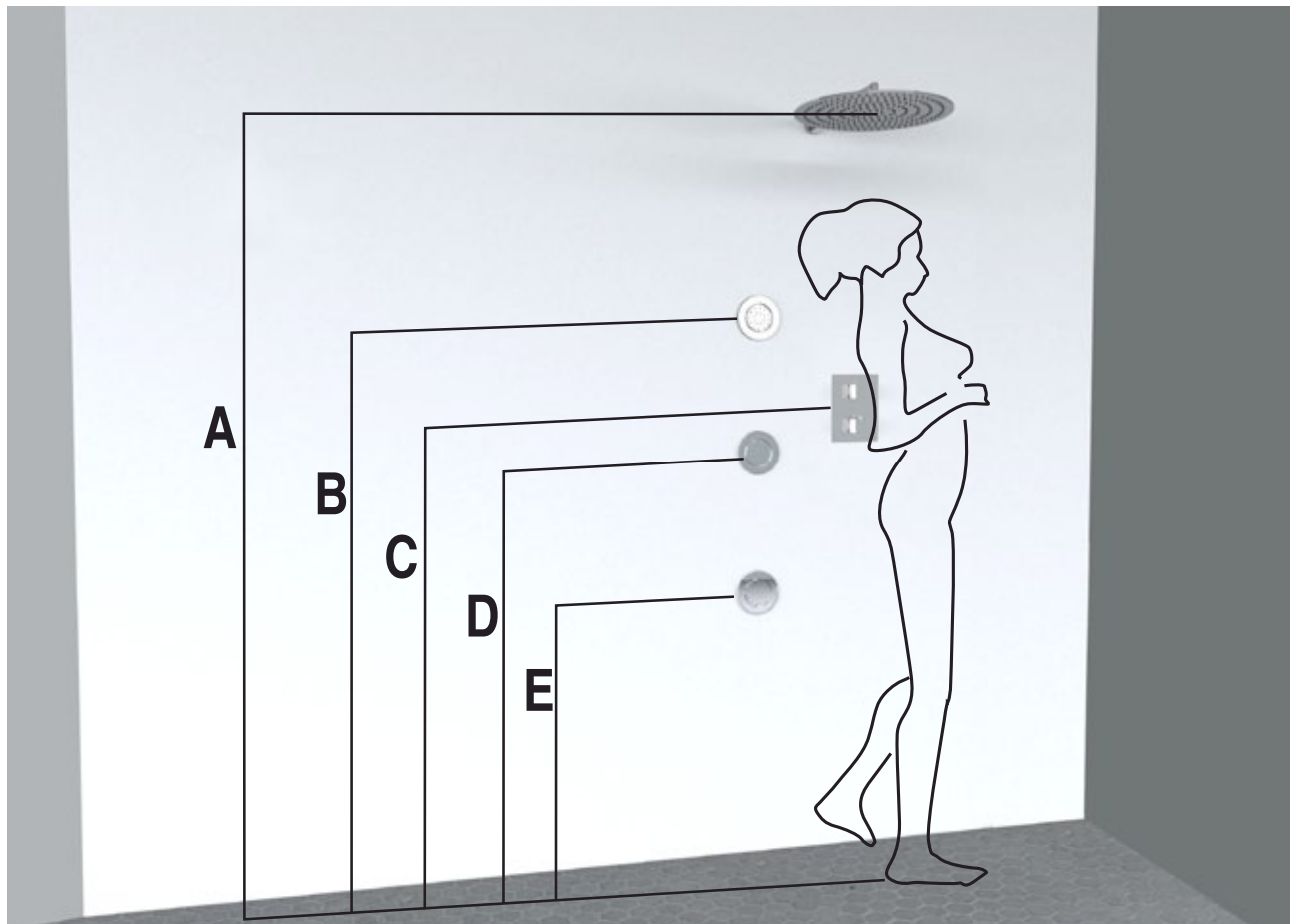

## showers2012

---

Fecha edición Edition data: Junio June 2012

Diseño Design: Dpto. Publicidad Noken

Fotografía Photography: Dpto. Publicidad Noken

Imprime Printed by: \_\_\_\_\_

Edita Edition: NOKEN DESIGN S.A.



ES11/9864

### **NOKEN DESIGN, S.A.**

**Ctra. Villarreal - Puebla de arenoso km. 2 (CV-20) - 12540 Vila-real · Castellón · Spain**

**Tel: +34 964 50 64 50 - Fax: +34 964 50 67 93 - e-mail: noken@noken.com - export@noken.com**

**www.noken.com**

NOKEN DESIGN, S.A.

El contenido de este catálogo está protegido por la Ley de Propiedad Intelectual, Real Decreto Legislativo 1/1996.

Cualquier reproducción del mismo, en parte o en su totalidad, sin autorización expresa de Noken Design, S.A. puede ser sancionada conforme el Código Penal.

NOKEN DESIGN, S.A.

Se reserva el derecho legal de anular y/o aportar posibles modificaciones a sus productos y accesorios sin previo aviso ni sustitución.

Los ambientes que se muestran en este catálogo son sugerencias decorativas de carácter publicitario,

debiéndose utilizar como guía para la instalación, las fichas técnicas que se encuentran en el PTC editado por Noken.

Reserves the right to cancel and/or change models or accessories without prior notice or replacement.

The settings shown in this catalogue are design proposals for advertising purposes. In real situations in which the tiles are laid, we recommend to use as a guide for the installation, the technical specifications available on the Noken PTC.

Depósito legal:





showers 2012

noken  
PORCELANOSA Grupo